

Ersatzteilliste Gas-Gebläsebrenner

Spare part list Gas burner

Vue éclatée Brûleur gaz





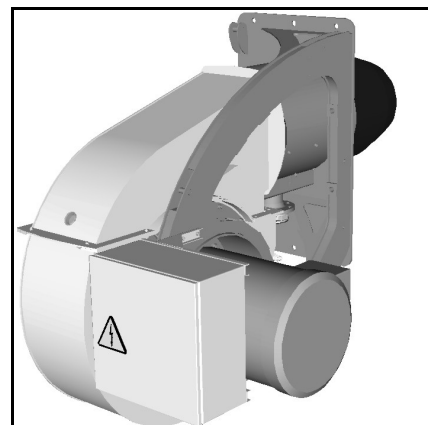
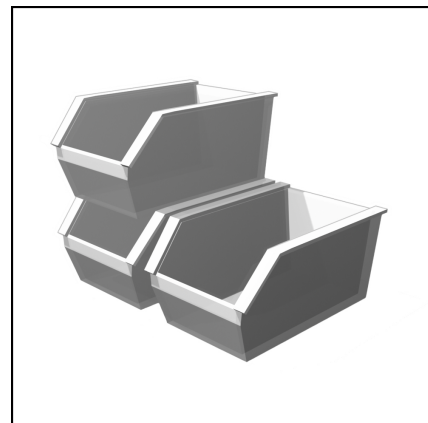

N 10.12000 G-EU2

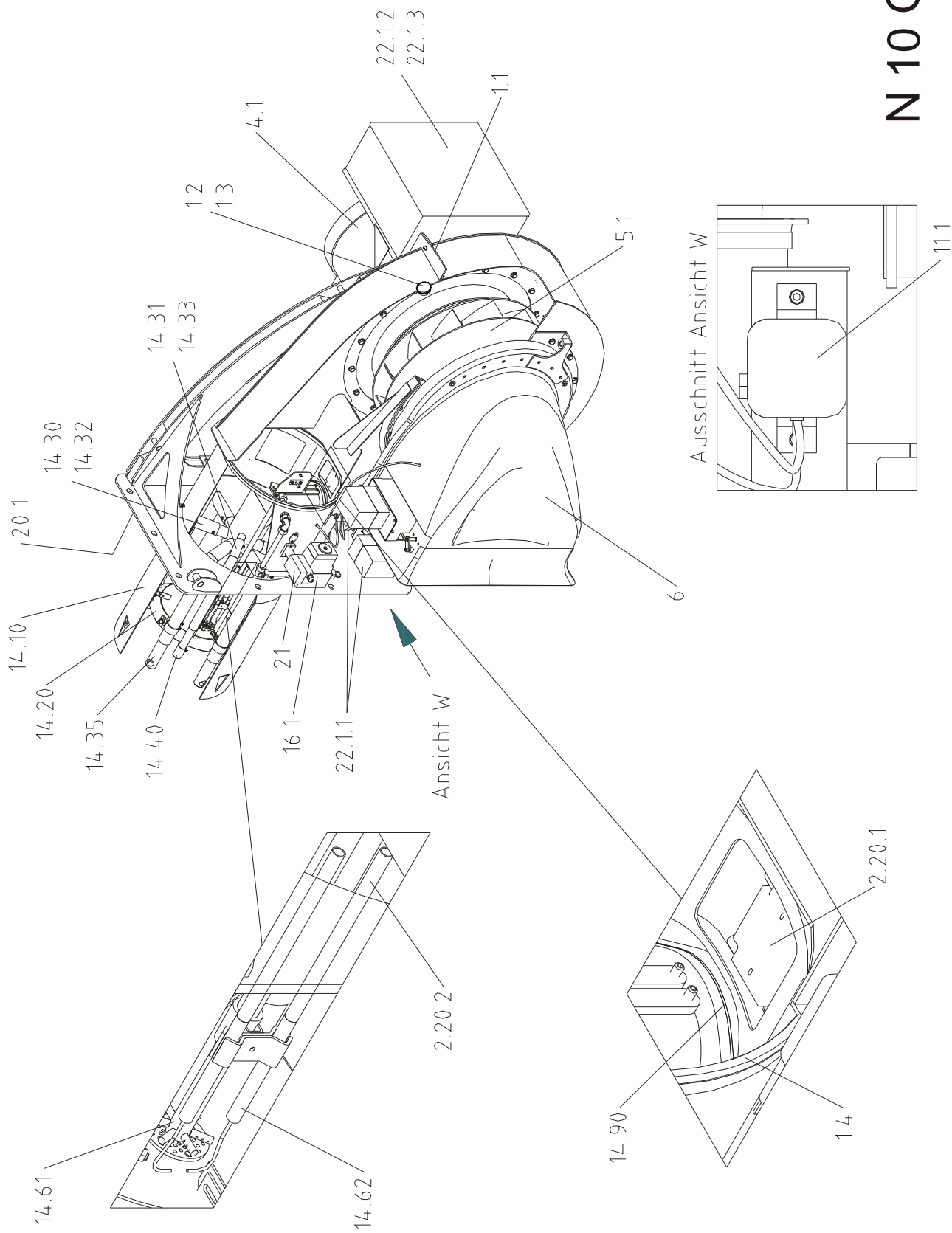
elco













N 10 G-EU2



	Pos.	Bezeichnung		Artikel-Nr.
	Pos.	Description		Article-No.
	Pos.	Description		Nr. articles
Baugruppe:	1	Grundausstattung	10 G-R/G-E	
Ass.group:		Basis equipment		
Ensemble:		Equipement de base		
	1.1	Zellkautschukstreifen Linkage ass. cover Profil en plastique	12 x 3	333.311.5453
	1.2	Schauglas Sight glass Regard	55x21	118.060.3227 
	1.3	Schauglasdeckel Sight glass cover Couvercle pour regard	D 55	118.805.2260 
	1.4	Dichtung (Profil) seal Joint	D 15	578.883.8175 
Baugruppe:	2.20.1	Zündtrafo	EBI 4 2POLIG	140.378.30
Ass.group:		Ignition transformer		
Ensemble:		Transformateur d'allumage		
Baugruppe:	2.20.2	Zündkabel BG für EBI		
Ass.group:		Ignition cable accessories		
Ensemble:		Câble d'allumage pour EBI		
	2.10.1	Zündkabel Ignition lead Câble d'allumage		173.873.9400
	2.10.2	Zündtrafokabel Ignition transformer cable Câble transformateur d'allumage	EBI 4 L=630 3polig	140.378.96
Baugruppe:	4	Motor BG LP	400/690V	
Ass.group:		Motor ass.		
Ensemble:		Moteur		
	4.1	Motor Motor Moteur	MOTOR 30,0KW 3000/MIN 400/690V 50	140.550.78 
Baugruppe:	opt. 4	Motor BG MP	400/690V	
Ass.group:		Motor ass.		
Ensemble:		Moteur		
	4.1	Motor Motor Moteur	MOTOR 37,0KW 3000/MIN 400/690V 50	140.550.67 
Baugruppe:	opt. 4	Motor BG HP	400/690V	
Ass.group:		Motor ass.		
Ensemble:		Moteur		
	4.1	Motor Motor Moteur	MOTOR 45,0KW 3000/MIN 400/690V 50	140.550.56 

	Pos. Pos. Pos.	Bezeichnung Description Description		Artikel-Nr. Article-No. Nr. articles
Baugruppe:	5	Ventilatorrad BG LP		
Ass.group:		Air fan ass.		
Ensemble:		Turbine		
	5.1	Ventilatorrad Air fan Turbine	D 675/90	124.885.8413
Baugruppe:	opt. 5	Ventilatorrad BG MP		
Ass.group:		Air fan ass.		
Ensemble:		Turbine		
	5.1	Ventilatorrad Air fan Turbine	D 680/93	124.885.6791
Baugruppe:	opt. 5	Ventilatorrad BG HP		
Ass.group:		Air fan ass.		
Ensemble:		Turbine		
	5.1	Ventilatorrad Air fan Turbine	D690/100	124.883.7730
Baugruppe:	6	Luftansaugkasten kpl.	STAHL RAL7035	140.342.44
Ass.group:		Air intake housing cpl.		
Ensemble:		Boîte à air cpl.		
Baugruppe:	11	Druckwächter BG	DL 50 A	
Ass.group:		Pressure switch		
Ensemble:		Pressostat différentiel		
	11.1	Luftdruckwächter Air pressure switch Pressostat air	DL 50A 2,5-50 mbar	333.312.3039

	Pos. Pos. Pos.	Bezeichnung Description Description		Artikel-Nr. Article-No. Nr. articles
Baugruppe:	14	Lanzengaskopf Grundl.	10.12000 G-U2	
Ass.group:		Lanee gas head basis ext.		
Ensemble:		Tête gaz multijet		
	14.10	Flammenrohr Grundl. Flame tube Gueulard	D491/497x700	163.883.8153 
	14.20	Stauscheibe Brake plate Accrocheur	D375 / 10.12000 G-U2	161.883.8244 
	14.30	Schiebewinkel / Hauptgas Adjusting tube Tube réglable		168.883.7763
	14.31	Schiebewinkel / Stützgas Adjusting tube Tube réglable		168.883.7785
	14.32	O-Ring	D 40,00x2,00 FPM - Viton grün	571.883.8131
	14.33	O-Ring	D 28,00x2,00 FPM - Viton grün	571.883.8142
	14.35	Gasdüse / Hauptgas Gas nozzle Injecteur gaz	D30x2 45grd 105/100	168.883.7774
	14.40	Gasdüse Gas nozzle Injecteur gaz	D 35x2,2 BO18	168.873.7379 
	14.60	Zündbrenner BG Ignition burner Pilote d'allumage	ZB 2	168.877.7762 
	14.61	- Zündbrenner Ignition burner Pilote d'allumage	ZB 2	168.829.4017 
	14.62	- Zündelektrode Ignition electrode Électrode d'allumage	D11x100x85mm	172.874.2005 
	14.90	Dichtung Ovalflansch Seal Joint	DN100	196.882.7383 
Baugruppe:	16	Zündgaskompaktarmatur BG	R1/2Z EK7-9	
Ass.group:		Ignition gas armature ass.		
Ensemble:		Robinetterie d'allumage		
	16.1	Zündgaskompaktarmatur Ignition gas armature Robinetterie d'allumage	CG15 R03D1-50W6	147.879.7282
	16.2	Kugelhahn Ball valve Vanne à boisseau	R 1/2Z BAUL.DIN3202-M3	120.005.11

	Pos. Pos. Pos.	Bezeichnung Description Description		Artikel-Nr. Article-No. Nr. articles
Baugruppe:	20	Beipack	10	
Ass.group:		Accessory		
Ensemble:		Accessoires		
	20.1	Isoglasband, weiß glas insulating tape bande isolante	B=30	496.873.6069
Baugruppe:	21	Überwachungsbaugruppe	10 G/GL (RU/EU)	
Ass.group:		Flame monitor system		
Ensemble:		Le contrôle de flamme		
	21.1	Flammenfühler Flame sensor Sonde de flamme	FFS 06 UV	175.884.3743 
	21.1 A	Flammenfühler Flame sensor Sonde de flamme	QRA 53 E	140.486.32 
	21.1 B	Flammenfühler Flame sensor Sonde de flamme	QRA 2	175.810.6258 
Baugruppe:	22	Elektroausstattung	10 G	
Ass.group:		Electric equipment		
Ensemble:		Electric montage en saillie		
	22.1 A	Elektromodul/BCS Gasbrenner Electric ass. Electric ass.	BCS-300	171.885.4911
	22.1.1	- Stellantrieb Actuator Servo-moteur	SAD 15.0	121.879.0509
	22.1.2	- Flammenwächter Flame detector Le détecteur de flamme	BCS-FLW 05	175.879.5195
	22.1.3	- BCS-Grundmodul BCS-basic module BCS-module base	BCS 300	175.879.1079
	22.1 B	Elektromodul / Etamatic Gasbrenner Electric ass. Electric ass.	Lamtec EVR	171.884.5669
	22.1.1	- Stellantrieb Actuator Servo-moteur	STM 30/40 Q15	121.879.0510
	22.1.2	- Etamatic OEM Grundgerät Electric ass. Electric ass.		175.884.3765

Ausstattung: Die Gasklappe ist kommissionsbezogen zu bestellen.

Equipment: The gas valve as ordered for commission specification.

Accessoires: Le registre gaz doit être commandé en fonction de l'installation.

Weitere Teile auf Anfrage.
Further spare part on request.
Autres pièces détachées sur demande.



Hilfsmaterial
Auxiliary material
Matériau auxiliaire



Verschleißteile
Wear parts
Pièces d'usure

Revision

Änderungen im Sinne der technischen Weiterentwicklung vorbehalten.
Modifications to incorporate latest technical developments are reserved.
Sous réserve de modifications résultant du perfectionnement technique.

Kundendienst:
Service:
Votre service après-vente:

ELCO GmbH
D-64546 Mörfelden-Walldorf

ELCO Austria GmbH
A - 2544 Leobersdorf

ELCOTHERM AG
CH - 7324 Vilters

ELCO Rendamax B.V.
NL - 1410 AB Naarden

ELCO Belgium n.v./s.a.
B - 1731 Zellik

ELCO Italia S.p.A
I - 31023 Resana (TV)