

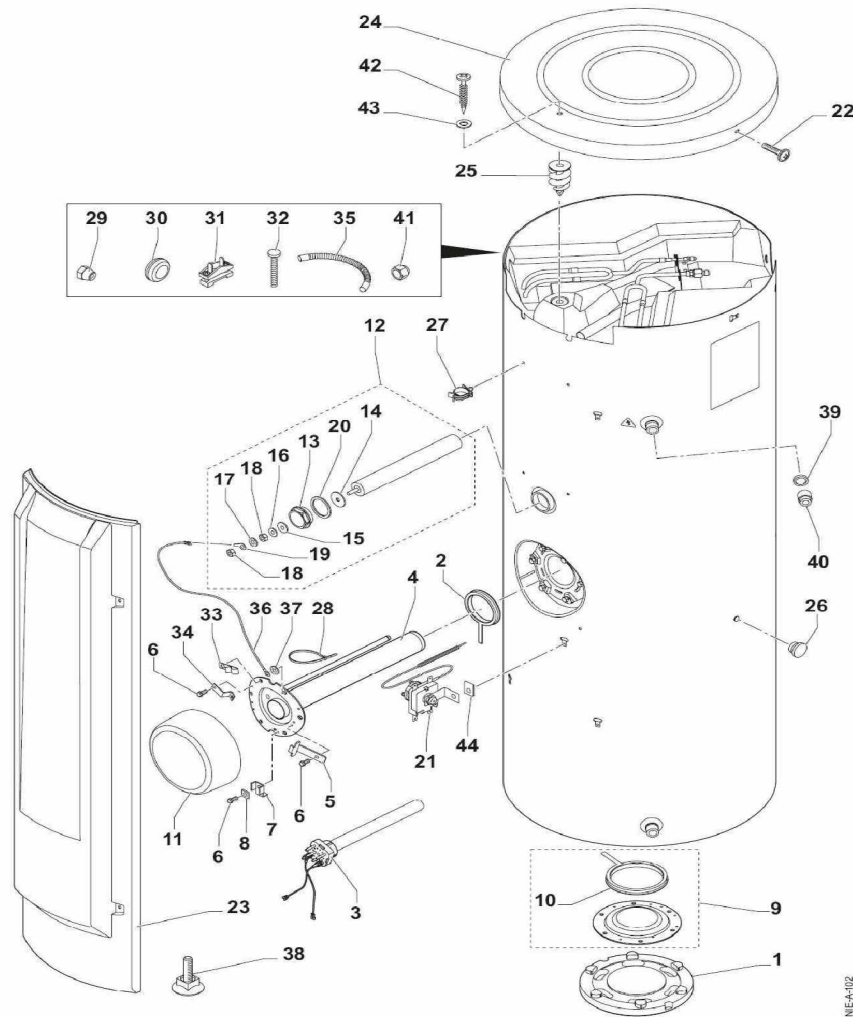

TD SPLIT

juil-15

CUVE 200 L



## BALLON TD SPLIT

Réf.	Référenc	Description	Qté	Tarif	Substitut	Tarif Sub.	Remarques
1	300026937	ISOLATION TAMPON SUP	1	2,90 €			
2	SD13133	JOINT A LEVRES D 82 TWH 300 E	1	4,40 €			
3	7614973	RESISTANCE PRE CABLEE 2400W	1				
4	7614372	CORPS CHAUFFE HZ-SS 100/150/200	1	71,90 €			
5	7607345	PLAQUETTE FIXATION ELEMENT B	1	24,00 €			
6	7617252	VIS HM5X10 CRANTE DIN7500D	1	1,05 €			
7	97525071	ETRIER CICE 9372-761	1	1,05 €			
8	97525072	PLAQUETTE CAR.CICE9210631	1	1,05 €			
9	SD25501	TAMPON SUPERIEUR COMPLET TV	1	69,40 €			
10	SD05511	JOINT 7 MM + JONC 5MM TWH 300E	1	13,50 €			
11	300025932	ISOLATION TAMPON	1	15,80 €			
12	7622491	ANODE MG 40X225 CPLT	1	58,90 €			
13	7615076	BOUCHON LAITON 1"1/2	1	11,30 €			
14	SD950140	JOINT DIAM. 25X8-5X2	1	2,50 €			
15	SD949745	ENTRETOISE NYLON 8 MM	1	1,05 €			
16	96100039	RONDELLE PLATE M8 ZN	1	1,05 €			
17	96140130	RONDELLE AZ 8 CADM. DET	1	1,05 €			
18	95800278	ECROU H M8 6 ZN6	1	1,05 €			
19	99100577	ROND DE MASSE A LANGUETTE	1	1,05 €			
20	SD300027	JOINT 60X48X3	1	1,80 €			
21	7626089	THERMOSTAT DE SECURITE CPLT	1	25,30 €			
22	7615467	VIS CBL H ST 3,9-19 C ZN3	1	1,05 €			
23	7627262	CAPOT AVANT 200L	1	69,40 €			
24	7628628	COUVERCLE CPLT	1	97,30 €			
25	7622976	CHEVILLE HELICOIDALE POUR ISC	1	2,50 €			
26	7601444	CAPUCHON	1	1,05 €			
27	SD953209	SUPPORT DE CABLE	1	1,05 €			
28	S1580062	COLLIER STA-STRAPS-SST 1.5	1	1,05 €			
29	368857	ECROU 1/4 SAE SCHRADER	1	1,40 €			
30	95320525	PASSE FIL 18X22X2	1	1,05 €			
31	SD20187	SERRE CABLE	1	5,90 €			
32	SD40600	VIS EC CB 3,5 X 25	1	1,05 €			
33	95320240	CLIP CABLE A FIXER	1	2,10 €			
34	7611795	TOLE DE MAINTIEN CABLE	1	4,10 €			
35	300011645	TUBE FLEXIBLE ANNELE DN19	1	2,50 €			
36	7628160	FIL D'ANODE MG	1	1,70 €			
37	96140130	RONDELLE AZ 8 CADM. DET	1	1,05 €			
38	SD60646	PIED REGLABLE M10X35 TWH300E	1	1,55 €			
39	0287914	JOINT 3X24X15 EPDM NBR 158-80 I	1	1,15 €			
40	7605675	Raccord diélectrique 3/4	1	4,90 €			
41	300025351	ECROU 3/8" FRIGO	1	4,30 €			
42	7628102	VIS CBL Z 4.5-35/28	1	1,05 €			
43	96110022	RONDEL L 5 N ZN	1	1,05 €			
44	97758856	ECROU RAPID	1	1,05 €			



TD SPLIT

juil-15

**GRUPE EXTERIEUR**

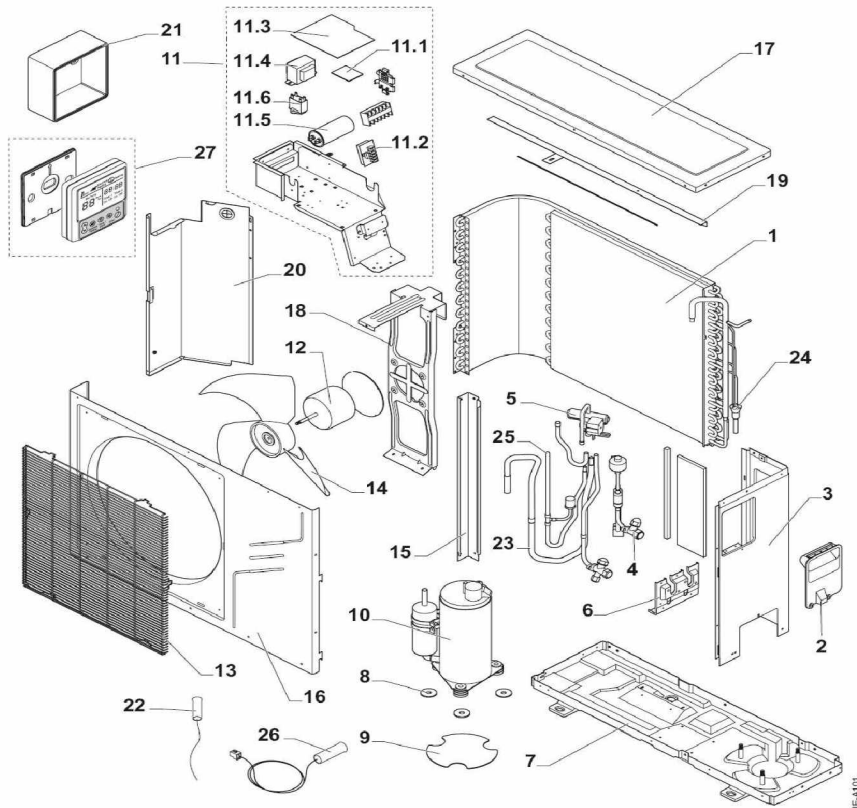

## BALLON TD SPLIT

Réf.	Référenc	Description	Qté	Tarif	Substitut	Tarif Sub.	Remarques
0	7660718	RACCORD CONDENSAT	1	3,60 €			
0	7660721	TUBE CONDENSAT	1	6,60 €			
0	7660723	CABLE RACCORDEMENT HMI	1	35,60 €			
1	7637563	EVAPORATEUR	1	382,00 €			
2	7637564	POIGNEE DE PROTECTION	1	3,70 €			
3	7637565	PANNEAU LATERAL	1	24,70 €			
4	7637567	LIGNE DETENDEUR	1	114,00 €			
5	7637568	ENS.VANNE 4 VOIES ET PRESSOS	1	130,00 €			
6	7637569	PLAQUE SUPPORT VANNES ARRE	1	7,20 €			
7	7637571	CHASSIS	1	56,60 €			
8	7637572	JOINT SOUS COMPRESSEUR	1	2,50 €			
9	7637573	SUPPORT JOINT SOUS COMPRESSEUR	1	3,70 €			
10	7637574	COMPRESSEUR	1	509,00 €			
11	7637575	BOITIER ELECTRONIQUE COMPLET	1	337,00 €			
11	7674792	BOITIER DE COMMANDE	1	337,00 €			Version R1
12	7637583	MOTEUR VENTILATEUR	1	96,60 €			
12	7674608	MOTEUR VENTILATEUR	1	60,80 €			Version R1
13	7637584	GRILLE DE PROTECTION	1	31,90 €			
14	7637585	VENTILATEUR	1	24,70 €			
15	7637586	SUPPORT LATERAL	1	6,10 €			
16	7637587	PANNEAU AVANT	1	54,20 €			
17	7637588	CHAPITEAU	1	35,30 €			
18	7637589	SUPPORT MOTEUR VENTILATEUR	1	17,80 €			
19	7637590	PLAQUE SUPPORT MOTEUR VENT	1	4,90 €			
20	7637591	PANNEAU DE SEPARATION	1	18,80 €			
21	7637592	SUPPORT MURAL AFFICHEUR	1	29,50 €			
22	7637593	SONDE TEMPERATURE AIR	1	3,80 €			
23	7637594	SONDE TEMPERATURE ASPIRATIC	1	7,20 €			
24	7637595	SONDE TEMPERATURE EVAPORATEUR	1	4,90 €			
25	7637597	SONDE TEMPERAT.REFOULEMENT	1	7,20 €			
26	7637598	SONDE TEMPERATURE ECS T5	1	126,00 €			
27	7637599	AFFICHEUR	1	136,00 €			
27	7674794	TABLEAU DE COMMANDE	1	88,10 €			Version R1
11 1	7637576	CARTE PUISSANCE RESISTANCE E	1	36,00 €			
11 2	7637577	CARTE CONNECTION AFFICHEUR	1	22,20 €			
11 2	7674607	CARTE CONNEXION AFFICHEUR	1	28,30 €			Version R1
11 3	7637578	CARTE UC	1	227,00 €			
11 3	7674606	CARTE UNITE CENTRALE	1	208,00 €			Version R1
11 4	7637580	TRANSFORMATEUR	1	43,60 €			
11 5	7637581	CONDENSATEUR COMPRESSEUR	1	15,30 €			
11 6	7637582	CONDENSATEUR VENTILATEUR	1	8,40 €			