









CORPS DE CHAUFFE BTI_Vue

Réf.	Référenc	Description	Qté	Tarif	Substitut	Tarif Sub.	Remarques
1	SH059437	CHARNIERE PORTE CHARGEMENT	1	Nous consulter...			
2	SH061223	TOLE SUSPENDUE FOYER D G	1				
3	SH059438	LOQUET PORTE CHARGEMENT ET	1				
4	SH059431	PORTE CHARGEMENT TOLE SEULI	1				
5	SH059459	CORDON PORTE CHARGEMENT D'	1				
6	SH059436	PORTE DE CHARGEMENT COMPLE	1	Nous consulter...			
7	SH016675	TRAPPE VISITE CANAL AIR PRIMA	1				
9	SH015090	PAPILLON ENTREE D AIR	1				
10	SH070116	JOINT ROND FIBRE D60/D36X10	1				
11	SH015340	CROCHET DE PORTE DOUBLE MOI	1				
12	SH040027	POIGNEE BAKELITE	1				
13	SH059430	PORTE DECENDRAGE TOLE SEULI	1				
14	SH012349	CORDON PORTE DECENDRAGE D'	1				
15	SH061014	REFRACTAIRE PORTE DECENDRA	1				
17	SH091025	SOLE REFRACTAIRE 340X167X30M	1	Nous consulter...			
18	SH015240	VOLET STOP AIR	1				
19	SH051598	ISOLATION INFERIEURE CORPS DE	1	Nous consulter...			
20	SH218874	SOLE REFRACTAIRE 340X280X30M	1	Nous consulter...			
21	SH061810	CREUSET SUSPENDU INOX	1	Nous consulter...			
22	SH507001	CORDON D8 L=1000MM	1	Nous consulter...			
23	SH061802	DEMI BRIQUE DROITE	1	Nous consulter...			
24	SH061801	DEMI BRIQUE GAUCHE	1	Nous consulter...			
25	SH091110	TURBULATEUR	1				
26	SH011771	JOINT SILICONE TRAPPE ARRIERE	1	53,10 €			
27	SH016663	TRAPPE RAMONAGE ARRIERE	1				
28	SH016628	JOINT SILICONE VENTILATEUR	1				
29	SH500129	VENTILATEUR AVEC TURBINE	1	909,00 €			
30	SH059468	TRAPPE SUPERIEURE COMPLETE	1				
31	SH059480	PORTE DECENDRAGE COMPLETE	1				
32	SH059469	PROTECTION ISOLATION	1				
33	SH059471	ISOLATION TRAPPE SUPERIEURE	1				
34	SH059467	CORDON TRAPPE SUPERIEURE D'	1				
35	SH059461	TRAPPE SUPERIEUR TOLE SEULE	1				
36	SH015241	CAPOT BOITE A AIR	1				
37	SH050014	VIS EPAULEE M6XD8X19 AXE CRO	1				
38	SH013367	SUPPORT OEILLETON 1	1				
39	SH011270	JOINT FIBRE OEILLETON D30XD23	1				
40	SH013139	VERRE OEILLETON D30X3,3MM	1				
72	SH013381	RONDELLES CARRES 25X25MM	1				



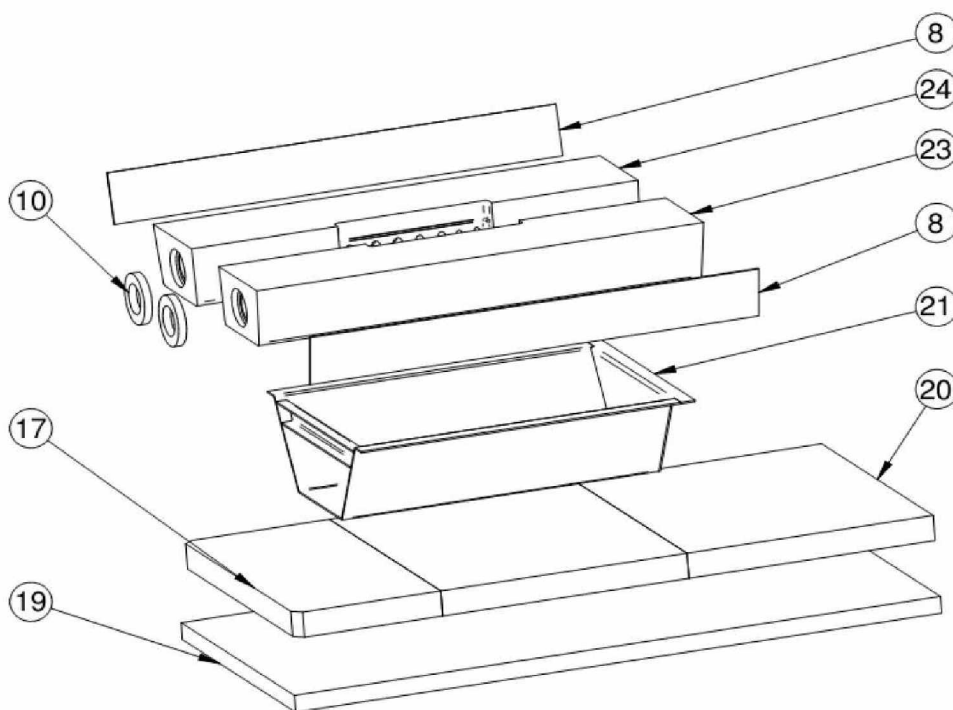

BTI

JANVIER 2013

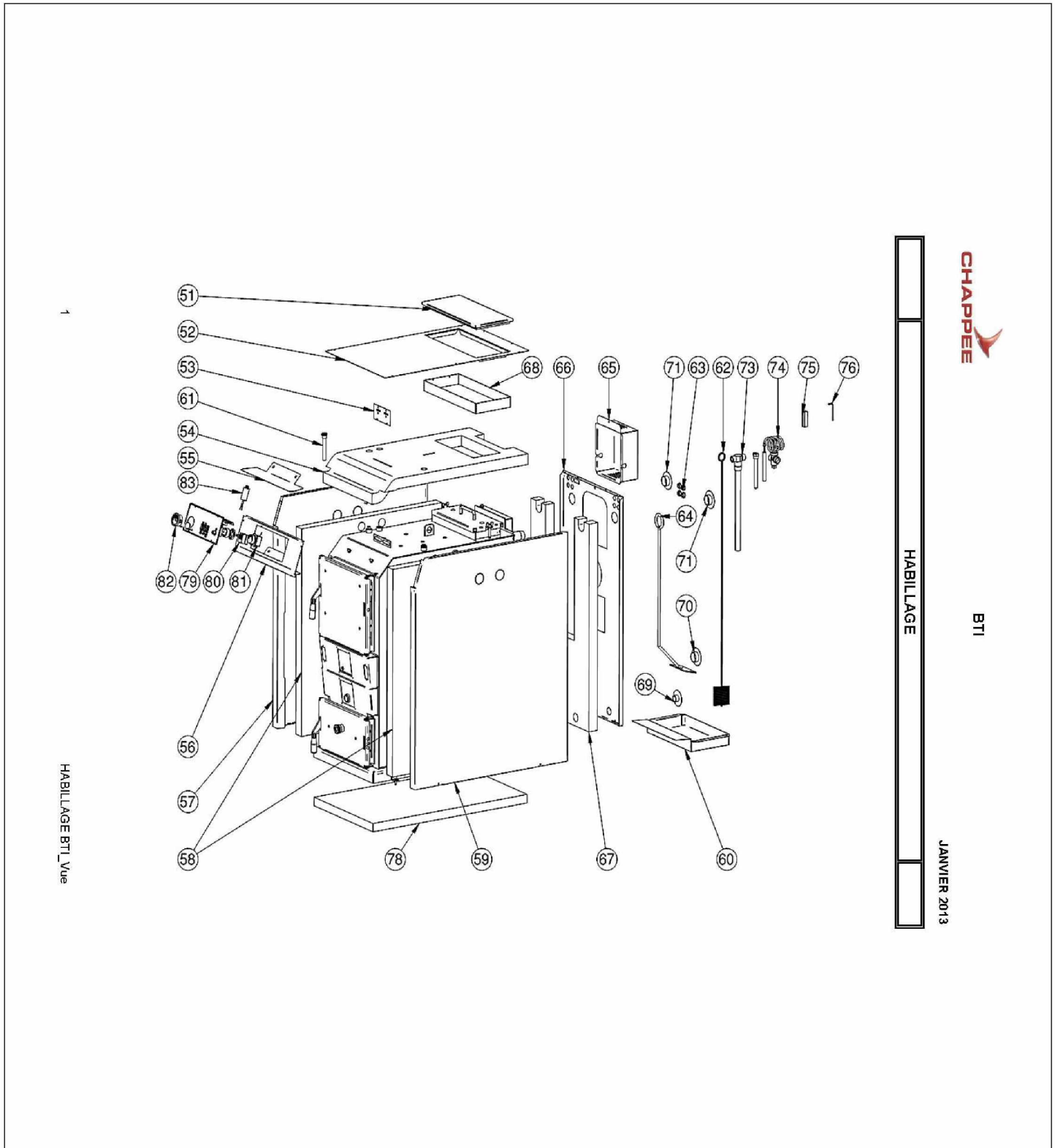

Réf.	Référenc	Description	Qté	Tarif	Substitut	Tarif Sub.	Remarques
8	SH504014	JOINT FIBRE DROIT ET GAUCHE BI	1				
10	SH070116	JOINT ROND FIBRE D60/D36X10	1				
17	SH091025	SOLE REFRACTAIRE 340X167X30M	1	Nous consulter...			
19	SH051598	ISOLATION INFERIEURE CORPS DE	1	Nous consulter...			
20	SH218874	SOLE REFRACTAIRE 340X280X30M	1	Nous consulter...			
21	SH061810	CREUSET SUSPENDU INOX	1	Nous consulter...			
23	SH061802	DEMI BRIQUE DROITE	1	Nous consulter...			
24	SH061801	DEMI BRIQUE GAUCHE	1	Nous consulter...			



Réf.	Référenc	Description	Qté	Tarif	Substitut	Tarif Sub.	Remarques
51	SH016651	COUVERLE JAQUETTE SUPERIEUF	1				
52	SH016639	JAQUETTE SUPERIEURE	1				
53	SH059487	TOLE SUPPORT THERMOSTATS	1				
54	SH016673	ISOLATION SUPERIEURE CORPS C	1				
55	SH016681	TOLE PROTECTION TABLEAU ELEC	1				
56	SH016654	BANDEAU SUPPORT TABLEAU COI	1				
57	SH016633	JAQUETTE LATERALE GAUCHE	1				
58	SH016672	ISOLATION LATERALE COTE DROI	1				
59	SH016635	JAQUETTE LATERALE DROIT	1				
60	SH042416	CENDRIER EXTERNE	1				
61	SH080026	DOIGT DE GANT SONDES 1/2" I120i	1	Nous consulter...			
62	SH210214	BROSSE TUBES DE FUMEEES	1				
63	SH040067	ROSACE NOIRE PASSE CABLE 20,5	1				
64	SH219008	RACLETTE LONGUE COUDEE	1				
65	SH016662	CAPOT VENTILATEUR	1				
66	SH016631	JAQUETTE FACE ARRIERE	1				
67	SH016671	ISOLATION FACE ARRIERE	1				
68	SH059481	ENCADREMENT TRAPPE RAMONA	1				
69	SH016705	ROSACE PLASTIQUE VIDANGE 3/4'	1				
70	SH016704	ROSACE PLASTIQUE BLEUE RETO	1				
71	SH016703	ROSACE PLASTIQUE ROUGE DEPA	1				
72	SH013381	RONDELLES CARRES 25X25MM	1				
73	SH503059	SERPENTIN DECHARGE THERMIQI	1	795,00 €			
74	SH509004	SOUPAPE DE DECHARGE THERMIK	1				
75	SH059002	OUTIL DEMONTAGE BOUCHON SEI	1				
76	SH059001	CLE HEXAGONALE 4MM	1				
78	SH061441	ISOLATION INFERIEURE CORPS DE	1				
79	SH015798	TABLEAU DE COMMANDE STANDA	1				
80	SH013110	THERMOSTAT DE FUMEEES	1				
81	SH090005	AQUASTAT CHAUDIERE	1				
82	SH080120	THERMOMETRE ROND 0-120Å°C	1	70,30 €			
83	SH500016	CONDENSATEUR 2 COMPOSANTS	1				