

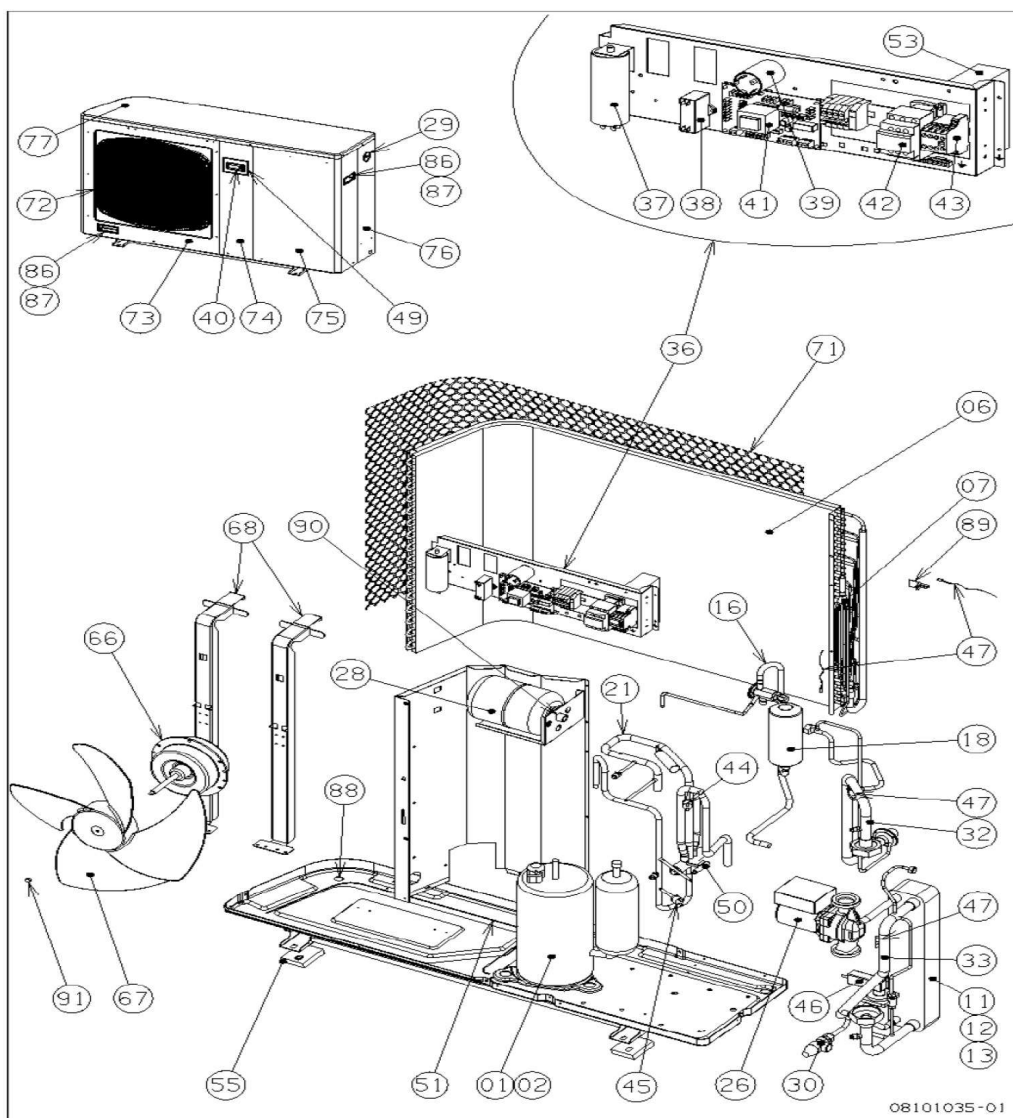









EXOLIA RO 6 BT

JANVIER 2009

C14BT0061A



08101035-01

Réf.	Référence	Description	Qté	Tarif	Substitut	Tarif Sub.	Remarques
1	SPAC6760	COMPRESSEUR 5JS270DDAA01 R4	1				
2	SPAC6760	ISOLANT COMPRESSEUR	1				
6	SPAC6760	ECHANGEUR ASSEMBLE	1				
7	SPAC6760	TUBE DISTRIBUTEUR	1				
11	SPAC6760	ENS.ECHANGEUR EAU 8 KW	1				
12	SPAC6760	ECHANGEUR AV.ISOLATION WP24	1				
13	SPAC6760	ECHANGEUR EAU WP24X20P5/8 1/	1				
16	SPAC6760	ENS.DETENDEUR 6-8 KW BP	1				
18	SPAC6760	BOUEILLE LIQUIDE 0,62L	1				
21	SPAC6760	VANNE 4 VOIES	1				
26	SPAC6706	CIRCULATEUR SXM 32/55 6H 230V	1				
27	SPAC6760	KIT RACCORD 2634 G2 1 EAU	1				[To Translat = ]
28	SPAC6760	VASE D'EXPANSION 2L	1				
29	SPAC6760	MANOMETRE 6B D50 + ETRIER	1				
30	SPAC6760	SOUPAPE 3B 1/2 FF	1				
31	SPAC6760	FILTRE TAMIS 3/4" RO6/7/8/9	1				[To Translat = ]
32	SPAC6760	ENS.TUBE POMPE 7-9 KW	1				
33	SPAC6760	ENS.TUBE 6-8 KW	1				
36	SPAC6706	ENSEMBLE ELECTRIQUE	1				
37	SPAC6706	CONDENSATEUR 60MF 450V	1				
38	SPAC6380	CONDENSATEUR 6MF C24.5 ARCO	1				
39	SPAC6706	FILTRE REGULATEUR ECH210BDT	1				
40	SPAC6706	REGULATEUR ECH 6KW BP	1				
41	SPAC6706	CARTE CONT.CHILLER	1				
42	SPAC6706	RELAY FINDER 40.528230 +SUPP	1				
43	SPAC6706	CONTACTEUR 8A(20A AC1)230VAC	1				
44	SPAC6706	PRESSOSTAT BP 0,5 - 2 BARS	1				
45	SPAC6706	PRESSOSTAT HP42/33BAR 061F83	1				
46	SPAC6706	PRESSOSTAT DIF.EAU	1				
47	SPAC6706	SONDE TEMPERATURE D'EAU	1				
47	SPAC6706	SONDE TEMPERATURE D'EAU	1				
47	SPAC6706	SONDE TEMPERATURE D'EAU	1				
50	SPAC6706	BOBINE ELECT.VANNE 4V LDK241	1				
51	SPAC6706	RESISTANCE TRACAGE DE CUVE	1	Nous consulter...			
53	SPAC6706	DEMARREUR PROGRESSIF ALCO I	1	1225,00 €			
55	SPAC6760	PLOT ANTI-VIBRATILE	1				
66	SPAC6706	MOTEUR VENTIL. Y7S623B54	1				
67	SPAC6380	HELICE 4 P	1				
68	SPAC6380	SUPPORT VENTILATEUR	1				
71	SPAC6760	GRI PROTECTION TRANSPORT 113	1				
72	SPAC6760	GRILLE	1				
73	SPAC6760	PANNEAU AVANT SIMPLE SANS GF	1				
74	SPAC6760	PANNEAU AVANT DROIT	1				
75	SPAC6760	PANNEAU AVANT DROIT	1				
76	SPAC6760	PANNEAU COTE DROIT	1				
77	SPAC6760	PANNEAU SUPERIEUR	1	Nous consulter...			
86	SPAC6230	POIGNEE	1				
86	SPAC6230	POIGNEE	1				

87	SPAC6230	JOINT DE POIGNEE X3	1
87	SPAC6230	JOINT DE POIGNEE X3	1
88	SPAC6230	COUDE PLAS.CANELE CONDENSE	1
89	SPAC6231	SUPPORT SONDE BATTERIE	1
90	SPAC6760	RACCORD VASE EXPANSION 1/2"	1
91	SPAC6380	ECROU	1