

Tab 669

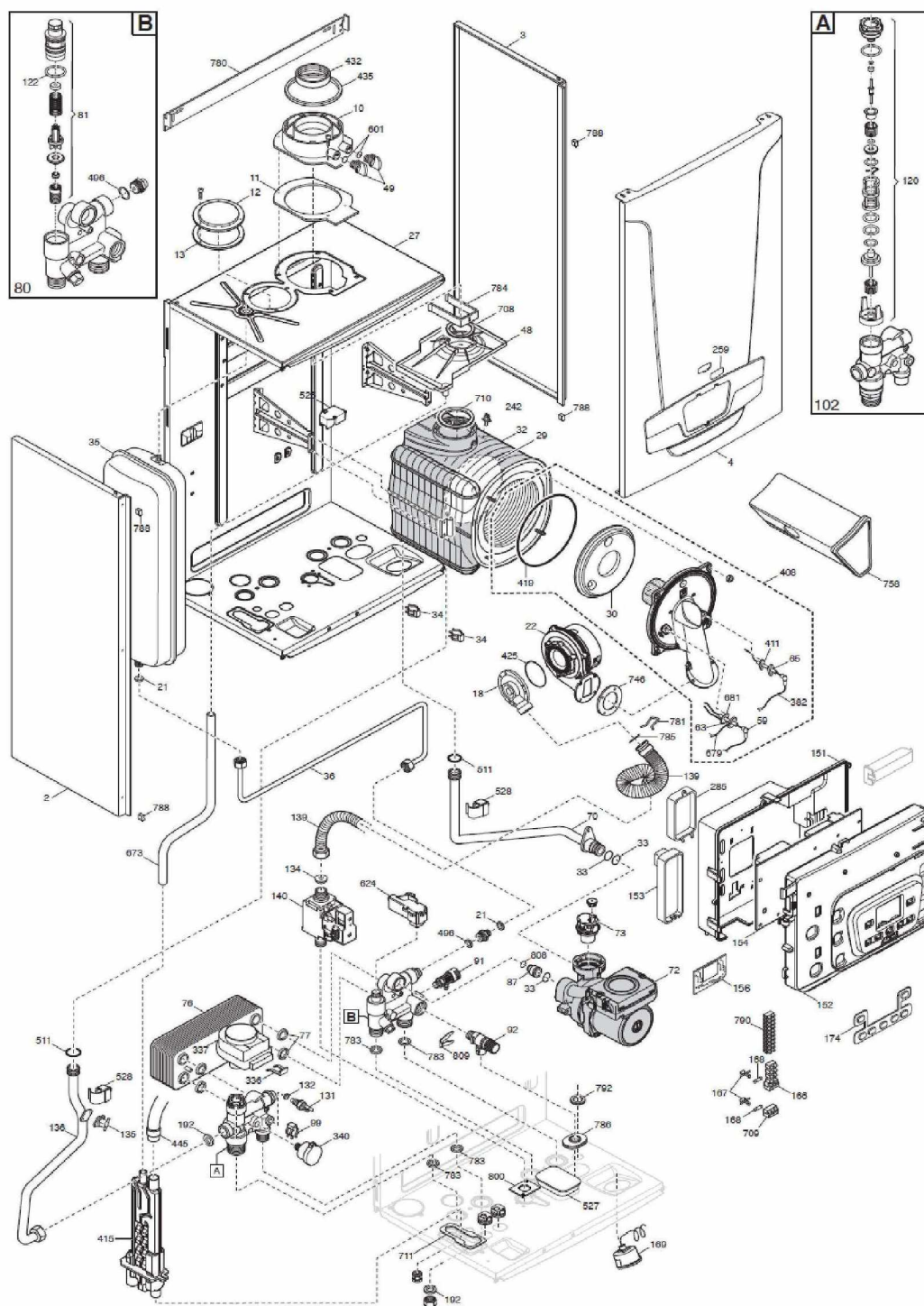

INITIA+ HTE 2.28

Réf.	Référence	Description	Qté	Tarif	Substitut	Tarif Sub.	Remarques
2	SX710066	PANNEAU GAUCHE INITIA PLUS	1				
3	SX710066	PANNEAU DROIT INITIA PLUS	1				
4	7648475	PANNEAU AVANT INITIA+	1	32,80 €			
10	SX540902	RACCORDEMENT VENTOUSE (1	1				
11	SX540901	JOINT VENTOUSE CAOUTCHOUC	1				
12	SX510869	OBTURATEUR (5108690)	1	1,05 €			
13	SX540740	JOINT OBTURATEUR DECOUPE (x3	1	1,05 €			
18	SX710078	VENTURI AGU3721	1				
21	SX540205	JOINT 6,1x11,5x1,5 (X3)	1				
22	7680621	EXTRACTEUR NRG118	1	155,00 €			
27	7216211	CHAMBRE ETANCHE	1	28,70 €			
29	SX710283	PANNEAU ISOLANT ARRIERE	1				
30	SX541102	PANNEAU ISOLANT (5411020	1				
32	SX567194	ECHANGEUR PRINCIPAL 4E (5	1				
33	SX710963	O-RING 22X3 EPDM (x3)	1	4,40 €			
34	SX838086	CLIPS ECHANGEUR PRINCIPAL	1				
35	SX710022	VASE D'EXPANSION 8L	1				
36	SX710157	TUBE LIAISON VASE	1				
48	SX710282	GOUTIERE AIR NEUF	1				
49	SX540928	BOUCHON RACCORD.VENTOUSE	1				
59	SX851352	CABLE ELECT.D'ALLUMAGE L=250	1				
63	SX710220	ELECTRODE ALLUMAGE HTE	1				
65	SX710220	ELECTRODE IONISATION HTE	1	18,40 €			
70	7669298	TUBE ECHANGEUR-POMPE	1	Nous consulter...			
72	7221855	POMPE UMP 15-60 6M AVEC CABL.	1				
73	7219215	DEGAZEUR CALEFFI WI	1	10,90 €			
73	SX710493	DEGAZEUR POMPE	1				
76	711613000	ECHANGEUR SANITAIRE 14 PLAQL	1	38,30 €			
77	711613500	JOINT ECHANGEUR SANITAIRE	1	1,55 €			
80	711608400	GR.ENT SANIT.8L/RET CHAUF.	1	62,90 €			
81	711633400	GROUP FILTRE LIMITEUR 8L	1	28,20 €			
83	SX566611	LIMITEUR DEBIT SANIT.8L/MN	1				
87	711652200	ELEMENT DE CONNEX.DE POMPE	1	2,90 €			
91	SX565203	ROBINET DE VIDANGE (PDM5€	1	4,40 €			
92	SX710109	SOUPAPE SECURITE 3BAR	1				
99	SX838085	CLIP TUBE BY-PASS	1				
102	711606100	ENSEMBLE VANNE 3 VOIES	1	55,70 €			
120	711356900	BOUCHON AVANT+PISTON V3V	1	60,90 €			
122	SX540537	O-RING "FILTRE SANITAIRE" (x3) (1	3,80 €			
131	SX843540	SONDE CTN (8435400)	1				
132	SX540283	JOINT SONDE SANITAIRE (X10) (1				
134	SX710070	DIAPHRAGME GAZ D6,2	1	1,75 €			
135	SX995076	SECURITE SURCHAUFFE 105Å° (9:	1				
136	SX710157	TUBE DEPART CHAUFFAGE	1				
139	7667942	TUBE GAZ FLEXIBLE	1	22,90 €			
140	SX710023	VANNE GAZ VGU86S	1				
151	SX710018	COUVERCLE BOITIER ELECTRIQUE	1	5,60 €			
152	SX710036	PANNEAU AV.TABLEAU DE BORD	1				
153	SX710018	CAPOT BORNIER DE RACCORDEM	1	1,05 €			

INITIA+ HTE 2.28

154	7222145	CIRCUIT LMS 14 MIXTE ERP	7222	1	
156	7222166	CIRCUIT IMPRIME AVS77 ENS.		1	41,20 €
166	SX842159	BORNIER DE RACCORDEMENT		1	
167	SX540534	PORTE-FUSIBLES (x3) (PDM540534		1	1,05 €
168	SX995058	FUSIBLES 2A 250V (X10) (995058C		1	
169	SX710554	MANOMETRE		1	
174	SX710100	CLAVIER DIPLAY 7 TOUCHES		1	
192	SX540465	JOINT G3/4" 17x24x2 (X10) #		1	
242	SX843527	SONDE CTN FUMEE		1	
259	SX710828	LOGO CHAPPEE		1	1,05 €
285	SX710083	CAPOT CLIP-IN		1	1,05 €
314	SX710071	CABLE RALLONGE IONISATION		1	
336	SX838068	RESSORT FIX MOTEUR V3V		1	
337	SX569458	MOTEUR V3V ELBI		1	
340	SX710109	CAPTEUR DE PRESSION		1	
382	SX851113	CABLE ELECTRODE IONISATION		1	
411	SX710185	JOINT ELECTRODE IONISATION		1	1,60 €
415	7658690	SIPHON HYDRAULIQUE H220		1	27,30 €
419	SX541100	JOINT BRIDE/ECHANGEUR		1	
428	SX540929	JOINT HUBLLOT (X3) (5409290)		1	
432	SX541042	JOINT FUMEEES Å~60		1	
435	SX540755	JOINT FUMEEES Å~100 (5407550)		1	
445	7217271	TUBE ECHANGEUR/SIPHON	72172	1	5,70 €
496	SX040002	O-RING 2062 (x3) (400020)		1	
511	SX540460	O-RING 17,86X2,62 (X3)		1	
525	SX843526	ALLUMEUR ANSTOS ZAG 2XV01 (8		1	
527	7215830	BOUCHON		1	2,10 €
528	SX710439	SONDE CTN TODS		1	
601	SX540856	O-RING 8,73X1,78 (x3) (5408560)		1	
624	SX843538	CAPTEUR DE DEBIT (843		1	
673	7220855	TUBE RACCORD CONDENSE/SIPHON		1	7,20 €
679	SX851115	CABLE MASSE ELECTR.D'ALL.L=27		1	
681	SX710185	JOINT ELECTRODE D'ALLUMAGE		1	
708	SX541097	JOINT D:60 (5410970)		1	1,05 €
709	SX842316	DOMINOS PORTE FUSIBLE(842316)		1	
710	SX541103	JOINT D:80 (5411030)		1	
711	7216964	JOINT SIPHON 721696400		1	1,25 €
746	SX541090	JOINT VENTILATEUR (5410900)		1	
758	SX710088	SILENCIEUX BOITE A AIR		1	12,30 €
780	SX710014	TRAVERSE FIXATION SUPERIEURE		1	
781	SX710011	CLIP FIXATION FLEXIBLE GAZ		1	
784	SX710123	SUPPORT REDUCTION AIR NEUF		1	
785	SX710061	O-RING 18x3 EPDM		1	
786	SX710387	JOINT EPDM SOUP./CAISSON		1	1,05 €
788	SX710176	JOINT CHAMBRE DE COMBUSTION		1	
790	SX710117	BORNIER M2		1	2,30 €
792	SX710189	BOUCHON EPDM NOIR		1	
800	7215821	JOINT VANNE GAZ		1	1,05 €
808	721311400	JOINT 18X2		1	1,35 €
809	7116150	RESSORT		1	1,05 €

INITIA+ HTE 2.28

999	SX841454	CABLE M1/TA	(8414540)	1	
999	SX841462	CABLE M1 ALIM ELEC	(841	1	
999	SX710038	CABLE X41/AFFICHEUR		1	
999	SX710057	CABLE X10/BORNIER M1		1	2,80 €
999	SX710062	CABLE X14/VG-ALLUMEUR		1	
999	SX710062	CABLE X21/M2-SONDE BALLON-EX		1	
999	SX710062	CABLE X42/M2-SONDE QAA		1	3,10 €
999	SX710066	CABLE X12/M1-TA		1	1,70 €
999	SX710071	CABLE RALLONGE CTN FUMEE		1	
999	SX710079	CABLE X20/M2 SONDES AUX		1	1,55 €
999	SX710103	CABLE MASSE		1	1,05 €
999	SX710514	CABLE X22/CTN		1	
999	711193200	CABLE V3V		1	5,90 €
999	7218355	CABLAGE PWM EXTRACT./POMPE		1	9,30 €
999	7669306	CABL. EXTRAC./POMPE WI.		1	19,40 €
999	7669308	CABL. EXTRAC./POMPE GR.		1	12,90 €
999	7656919	BOUCHON DE SIPHON (JAUNE)		1	3,20 €

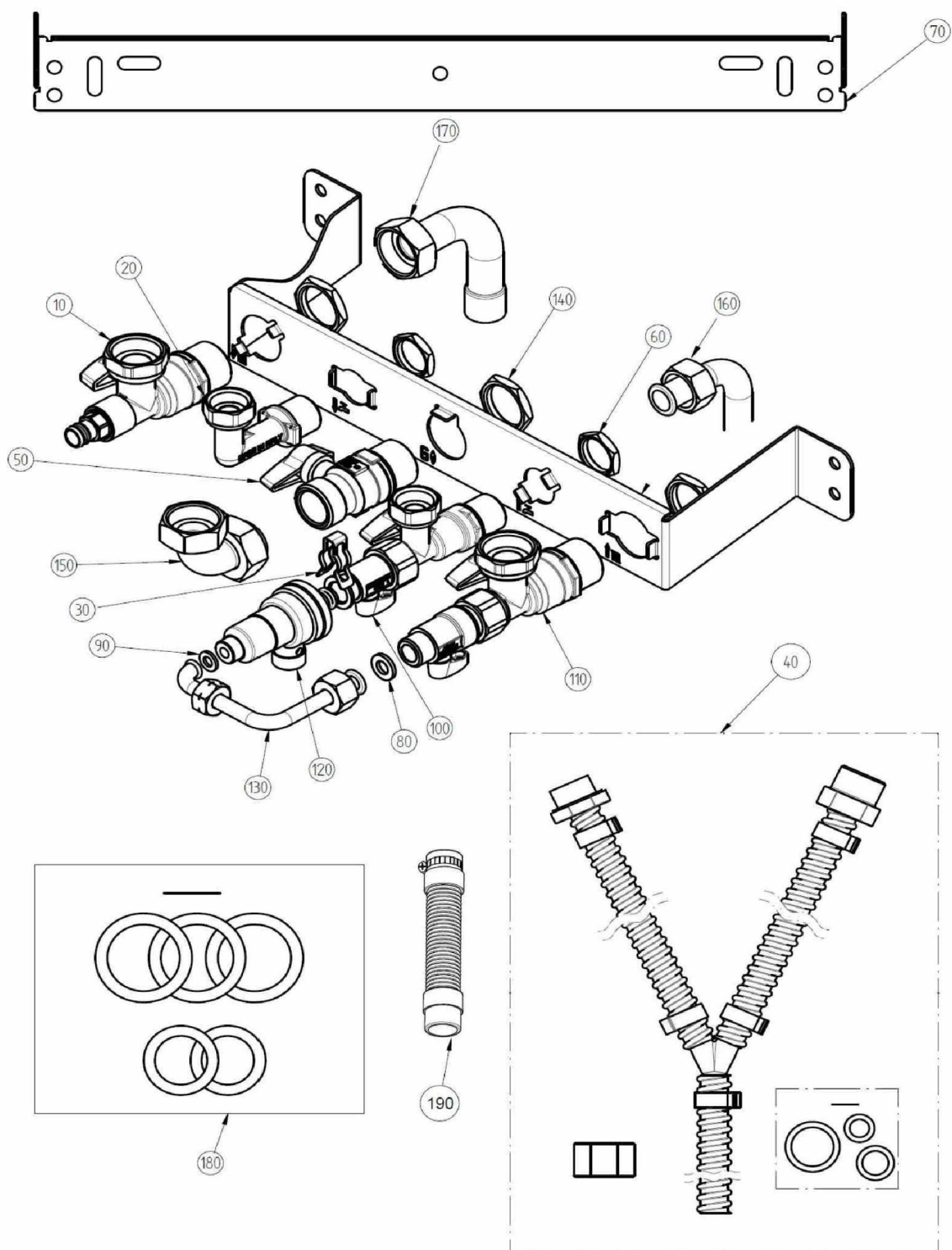



INITIA + HTE (2015 -> ...)

INITIA+ HTE 2.28

Réf.	Référenc	Description	Qté	Tarif	Substitut	Tarif Sub.	Remarques
10	SX710788	ROBINET DEPART CHAUFFAGE	1				
20	SX710788	COUDE DEPART ECS	1				
30	SX511253	RESSORT FIXATION DISCONNECTI	1	1,05 €			
40	SX710467	COLLECTEUR DE VIDANGE	1				
50	SX710788	ROBINET DE GAZ	1				
60	SX520954	ECROU G1/2	1				
70	SX710014	TRAVERSE FIXATION SUPERIEURE	1				
80	SX540497	JOINT 3/8" (x10) (PDM5404970)	1				
90	SX540205	JOINT 6,1x11,5x1,5 (X3)	1				
100	SX710826	ROBINET EF	1				
110	SX710826	ROBINET RET.CHAUFFAGE	1				
120	SX710796	DISCONNECTEUR	1				
130	SX710808	TUBE DISCONNECTEUR	1				
140	SX995032	CONTRE ECROU G 3/4 (9950320)	1				
150	SX710829	TUBE GAZ	1				
160	SX710777	DOUILLE COUDE EF/ECS	1				
170	SX565763	TUBE D:18 (5657630)	1				
180	SX563285	POCHETTE DE JOINT	1				
190	SX061743	TUBE SORTIE SIPHON	1				