

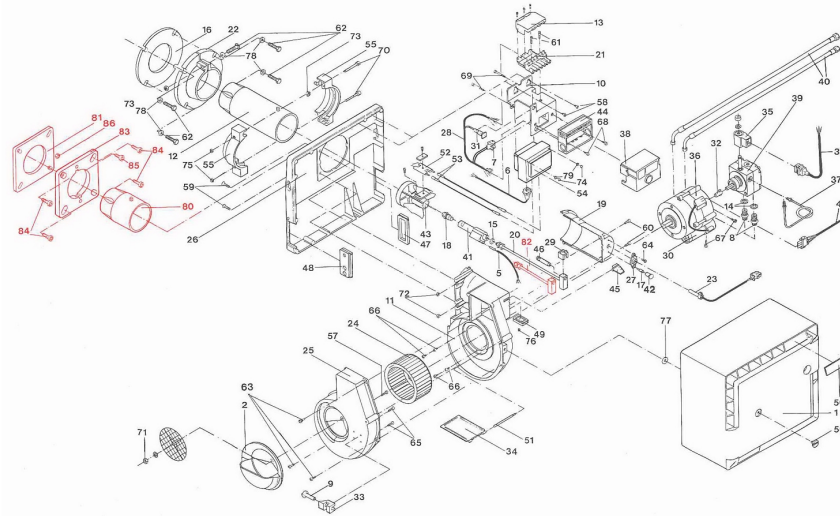







BMR 22-32-52



Ersatzteile für Brenner BMR 22/32/42 (Herrmann HL 50), Spare parts for burners BMR 22/32/42, Pièce de rechange pour les brûleurs BMR 22/32/42					
Düsenstockrohr komplett (223,5 mm) für Brenner BMR mit Scheibeflansch	Nozzle fitting pipe complete (223,5 mm) for burner BMR with sliding flange	Tube de bâton du gicleur complète (223,5 mm) pour brûleur BMR Bride coulissante	10009.00013	537D1036	
Düsenstockrohr komplett (101,5 mm) für Brenner BMR mit Uniflansch	Nozzle fitting pipe complete (101,5 mm) for burner BMR with uniflange	Tube de bâton du gicleur complète (101,5 mm) pour brûleur BMR Unite	10009.00024		
Ölvorwärmer FPHB 5, PTC 50, T 60/32, 30-90 W (10021.00012)+ Düsenstockrohr komplett (101,5 mm) für Brenner BMR mit Uniflansch (10009.00024)	Oil preheater FPHB 5, FPHB 5, PTC 50, T 60/32, 30-90 W (10021.00012) + Nozzle fitting pipe complete (101,5 mm) for burner BMR with uniflange (10009.00024)	Préchauffeur de froul FPHB 5, FPHB 5, PTC 50, T 60/32, 30-90 W (10021.00012)+ Tube de bâton du gicleur complète (101,5 mm) pour brûleur BMR Unite (10009.00024)	10003.00147		
Zwischenflansch 2-teilig	Intermediate flange (2 parts)	Flasque biparte	10002.00011	53429086	
Ölvorwärmer FPHB 5, PTC 50, T 60/32, 30-90 W	Oil preheater FPHB 5, FPHB 5, PTC 50, T 60/32, 30-90 W	Préchauffeur de froul FPHB 5, FPHB 5, PTC 50, T 60/32, 30-90 W	10021.00012	53429132	
Motor EB95C28 mit Kondensator	Motor EB95C28 with capacitor	Moteur EB95C28 avec condensateur	10016.00004	53429133	
Ölpumpe BFP 21 L3	Oil pump BFP 21 L3	Pompe à froul BFP 21 L3	10019.00004	537D8033	
Gewindestar Ø108x52 incl. Gewindestift mit Kegekkuppe und Innensechskant DIN 913 M5x5	Blower wheel Ø108x52	Roue de ventilateur Ø108x52	10012.00003	53429135	
Gewindestar Ø120x52 incl. Gewindestift mit Kegekkuppe und Innensechskant DIN 913 M5x6	Blower wheel Ø120x52	Roue de ventilateur Ø120x52	10012.00001	53429030	
Magnetspule für Ölpumpe	Solenoid coil for oil pump	Bobine d'électroaimant pour pompe	10019.00002	53429136	
Stauscheibe B	Baffle plate B	Disque reducteur de pression B	10015.00026 20	53429137 38	
Stauscheibe A/E	Baffle plate A/E	Disque reducteur de pression A/E	10015.00024 24	53429138 37	
Kabel Zündeinheit-Elektrode (ohne Erstwiderstand, 500 mm lang)	Cable ignition unit-ignition electrode (without resistor, length 500 mm)	Cable unite d'allumage-electrode d'allumage (sans resistance, longueur 500 mm)	10013.00008	53429140	
Brennerrohr Unit	Burner tube unit	Tube de brûleur unite	10006.00095	53429141	
Ölvorwärmer FPHB 5, PTC 50, T 60/32, 30-90 W (10021.00012)+ Düsenstockrohr komplett (223,5 mm) für Brenner BMR mit Schiebeflansch (10009.00013)	Oil preheater FPHB 5, FPHB 5, PTC 50, T 60/32, 30-90 W (10021.00012) + Nozzle fitting pipe complete (223,5 mm) for burner BMR with sliding flange (10009.00013)	Préchauffeur de froul FPHB 5, FPHB 5, PTC 50, T 60/32, 30-90 W (10021.00012)+ Tube de bâton du gicleur complète (223,5 mm) pour brûleur BMR Bride coulissante (10009.00013)	10003.00146	53429142	
Kupplung	Clutch	Accouplement	10016.00009	53429143	
Fotowiderstand LDS rot	Photo resistor LDS red	Photorésistance LDS rouge	10011.00020	53429145	
Schlauch 1100 mm	Oil pipe 1100 mm	Tuyau à froul 1100 mm	10020.00001	53429147	
Kontrolllampe grün	Control lamp green	Témoins vert	10030.00008	53429148	
Kondensator 3 µF	Capacitor 3 µF	Condensateur 3 µF	10016.00005	53429149	
Zündeinheit EB14	Ignition unit EB14	Unité d'allumage EB14	10026.00010	53429151	
Düsenstockrohr mit Düsenhalter (144,5 mm)	Nozzle fitting pipe with nozzle holder (144,5 mm)	Tube de bâton du gicleur avec cadre support pour gicleur (144,5 mm)	10009.00057	53429153	
Kabel Feuerungsautomat-Magnetspule	Connection cable for solenoid coil	Câble de connexion de bobine d'électroaimant	10013.00010	53429154	
Kabel Feuerungsautomat-Motor	Connection cable for motor	Câble de connexion du moteur	10013.00003	53429155	
Kabel Verbindungsbuchse-Ölvorwärmer	Cable connection socket-oil preheater	Câble prise mâle de connexion-préchauffeur de froul	10013.00081	53429156	
Kabel Feuerungsautomat-Verbindungsbuchse Fotowiderstand	Cable connection control unit-socket photo resistor	Câble prise mâle de connexion-photosensistance	10013.00037	53429157	
Brennerrohr A/B	Burner tube A/B	Tube de brûleur A/B	10006.00085	53429158	
Zündelektrodenblock	Ignition electrode bloc	Bloc d'électrodes d'allumage	10025.00009	53429161	
Kabel Feuerungsautomat-Zündeinheit	Connection cable for ignition unit	Câble de connexion de l'unité d'allumage	10013.00092	53429162	
Magnetspule für Ölpumpe	Solenoid coil for oil pump	Bobine d'électroaimant pour pompe	10019.00002	53429164	
Filterpatrone für Ölpumpe	Filter cartridge for oil pump	Cartouche filtrante pour pompe	10019.00003	53429274	
Dichtung für Flansch	Gasket for flange	Joint d'étanchéité pour la bride	10006.00003	53429159	
Dichtung für Uniflansch	Gasket for flange unit	Joint d'étanchéité pour la bride unite	10006.00066	53429163	







BMR 22-32-52

Code	Code GA	Quant.	Photo	Description	De --- A ---	Remarque
53429030	785040	1		Roue ventil.120x52 BMR32-52		
53429086	788123	1		Bride interm.BMR22-32-52 ->537D8143		
53429132	785065	1		Préchauffeur (seul) FPHB 5 (->FPHE 5)		
53429135		1		Roue ventil.108x52 BMR 22-32-52		
53429136	785067	1		Bobine électrovanne BM R 22-32-52		
53429137	785068	1		Accroche flamme 4 fentes BMR32 (HL50A)		4 slots BMR32
53429138		1		Accroche flamme 12 fentes BMR52 (HL50B)		12 slots BMR52
53429140	785069	1		Câble haute tension BMR22-32-52 U N		
53429142	785070	1		Ligne gicl.L211 complete BMR22-32-52 N		
53429143	785071	1		Accouplement BMR 32-52		
53429145	785072	1		Cellule (LDS rouge) BM R 22-32-52		
53429147		1		Flexible fioul BM R 22-32-52		
53429148	785073	1		Voyant vert préchauffage BMR 32-52		
53429149	785074	1		Condensateur 3µF BMR22-32-52		
53429151	785075	1		Transfo allumage EBI 052F0030		
53429153	785076	1		Ligne gicl.L101 sans préch.BMR22-32-52U		
53429154		1		Câble électrovanne BMR 22-52		
53429155		1		Câble moteur BMR 22-52		
53429156		1		Câble prechauffeur fioul BMR 22-52		
53429157		1		Câble cellule BMR 22-52		



BMR 22-32-52

Code	Code GA	Quant.	Photo	Description	De --- A ---	Remarque
53429158		1		Tube de combustion "N" BMR 22-52		
53429161	785077	1		électrode BM R 22-32-52		
53429162		1		Câble transfo allumage BMR 22-52		
53429164		1		Bobine électrovanne pompe BMR 22-52		
53429274		1		Cartouche filtre pompe BMR 22-52		
537D1015	786071	1		Gicleur 1.00 Gus 60°B		for BMR52 U
537D1036	786083	1		Tube porte-gicleur BMV1-2 (223,5mm)		
55429159	785279	1		Joint bride ronde BMV & BMR22-32-52		
55429163		1		Joint bride U BM R 22-32-52 (557a0039)		
537D8033	786375	1		Pompe BMV1 (Danfoss BFP21 L3 R) +bobine	01-06-18-	Prev: 53429134