















Panels+acc. HM85TC V13

Code	Code GA	Quant.	Picture	Description	From --- To ----	Remark
1	21479487	1		Panel upper front HM70-85-120TC	01-11-13-	
2	21475487	784636	1	Top panel rear HM70-85-120TC	01-11-13-	
3	507F3047	785944	1	Adapter 100+100->100-150 HM70-120TC	01-11-13-	
4	20474487		1	Rear panel HM70-85-120TC	01-11-13-	
5	21471487		2	Side panel LH&RH HM70-85-120TC	01-11-13-	
6	537D6258	786243	1	Flue pipe D100x1650 HM70-85-120TC	01-11-13-	
7	537D6438	786295	1	Elbow 90° MF DN100 PP grey +lip seal	01-11-13-	
8	557A1056	786672	1	 -OBS- Low pressure switch 1/4 0,5-0,8 bar	01-11-13-31-12-15	Prev : 557A1056
8A	A1002747	787022	1	 Low press.switch 1/4 CEME	01-01-16-	
9	55426001	785274	1	 Drain cock 1/2	01-11-13-	
10	557A0106	786601	1	 Lip gasket DN100 HR-EPDM black	01-11-13-	
11	497b4014	785893	1	Condens.coélect.HM85TC + gasket	01-11-13-	
12	557A0145	786621	1	 Gasket ID:250 condens.coélect.HM85TC	01-11-13-	
13	557A0144	786620	1	 Gasket 28-45x5 Viton cond.coélect.HMTC	01-11-13-	
14	557A4025	786707	1	 Pump Top-S 25/7 L180 G6/4 grey	01-11-13-31-07-15	non ERP
14A	257F1143	785791	1	 Pump HEP wired HM70->120TC V13 (ERP)	01-08-15-	ERP
15	21476426		1	Front panel base HM70-85TC	01-11-13-	
16	21473486		1	Front panel lower HM70-85-120TC (V13)	01-11-13-	
17	21477486		1	Control panelHM70-85-120TC (V13)	01-11-13-	
18	21478426	784678	1	Front panel upper HM70-85-120TC	01-11-13-	



Panels+acc. HM85TC V13





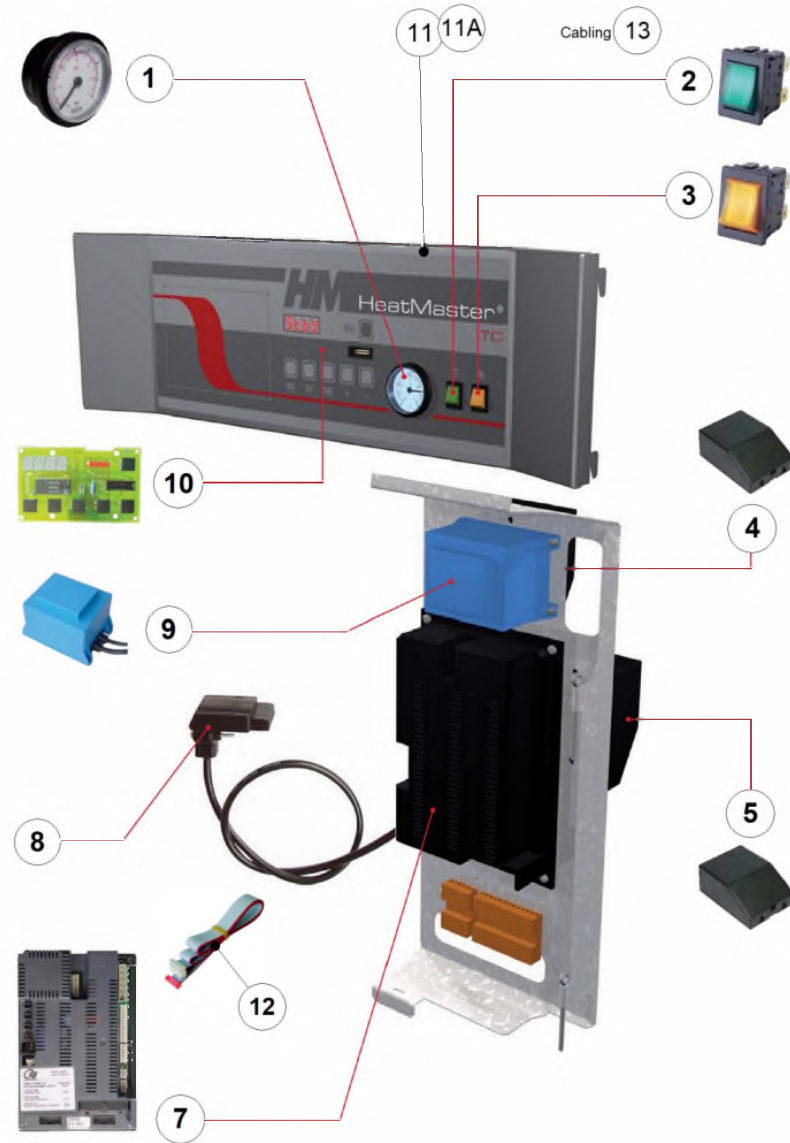





Code	Code GA	Quant.	Picture	Description	From --- To ----	Remark	
19	507F4137	785972	1		Gas pipe HM70-85TC	01-11-13-	
20	537D6238	786234	1		Flexible hose air D80 L320	01-11-13-	
21	537DC000	786426	1		Gas pressure switch Prest.-HMTC	01-11-13-	
22	537D6352	786269	3		Elbow 90° MF DN80 PP black (air)	01-11-13-	
23	557A3001	786695	1		Air vent auto.1/2 brass	01-11-13-	
24	39438046	784824	1		Dry well SST 1/2x950	01-11-13-	
25	537D6135	786190	1		Reducer FF 80x50 for air inlet	01-11-13-	
26	557A7006	786723	2		Exp.vessel 10L CH	01-11-13-	
27	A1003132	787101	1		Siphon WH50 w/ball+ring+seal	01-10-16-	PREV 557A8004
28	2047A486	785705	1		Bracket for control panel HM70-85-120TC	01-11-13-	
29	30540612	784812	1		Body foamed HM70-85TC (V13)	01-11-13-	
30	557A1076	786682	1		Safety valve 3bar 100kW 1/2	01-11-13-	
31	547D3018	786561	1		NTC sensor 12K L1500 for tank	01-11-13-	
32	5476G008	786492	1		NTC sensor 12K d5x18 1/8 +faston	01-11-13-	
33	507F4269	786015	1		Recirculation pipe HM70-85-120TC	01-11-13-	
34	557A0101	786598	2		Gasket Dn100 (flue pipe) blue	01-11-13-	
35	4779A011	785844	1		Nut 3/4' DIN431A SST HMTC	01-11-13-	

Control panel HM85TC





Control panel HM85TC





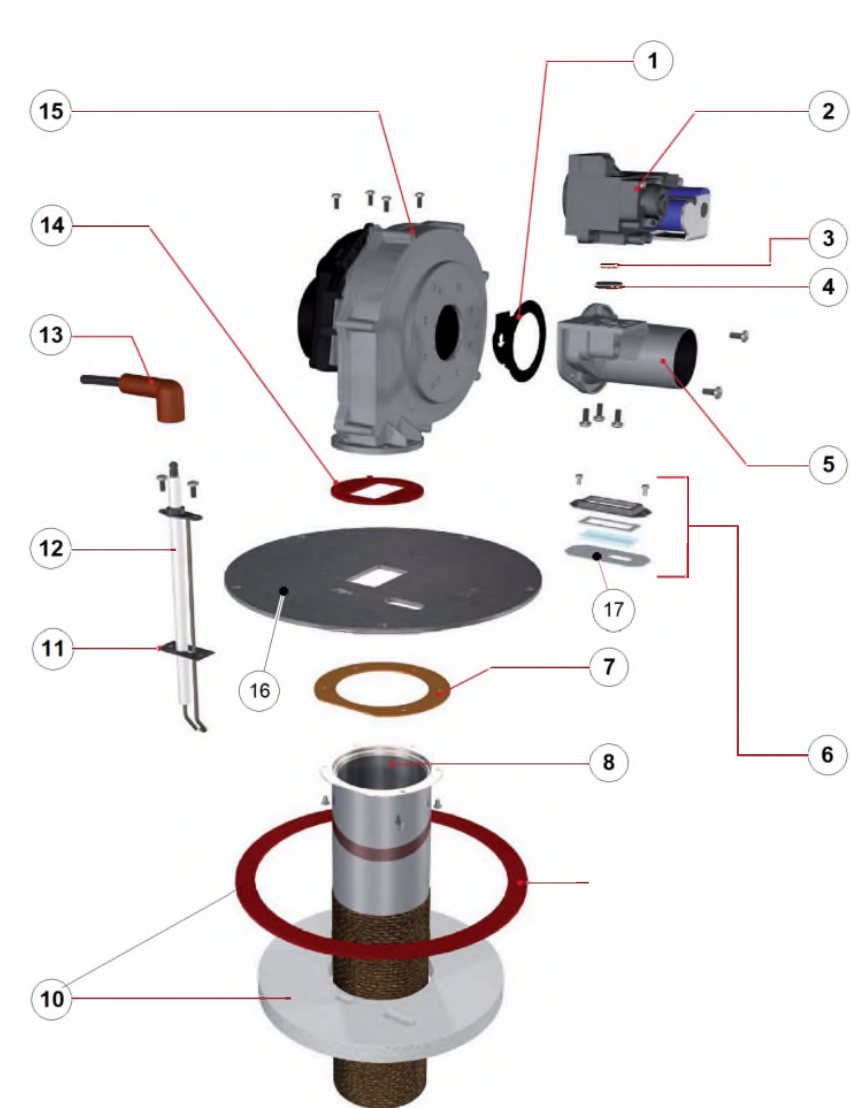











Code	Code GA	Quant.	Picture	Description	From --- To ----	Remark
1	54763017	785201	1	 Manometer 0-4 bar & 60psi D:37 black		
2	54766016	785234	1	 Switch 2P green		
3	54766017	785235	1	 Switch 2P yellow		
4	10800094	784374	1	 Kit alarm module AM3-2		OPTION
5	10800095	784375	1	 Kit second heating circuit AM3-11		OPTION
7	5476G043	786515	1	 MCBA preset for HM85TC		
8	537D3039	786102	1	 Cable L:1260 with rectifier 24V		
9	547D3021	786562	1	 Transfo.230/24V 72VA+ cable 35cm MCBA		
10	537D3020	786091	1	 Display for MCBA		
11	24614162		1	Contr.pan.cpl HM85TC	-01-02-13	
11A	24614196		1	Contr.pan.cpl HM70-85TC (V13)	01-02-13-	V13
12	257F1079	785764	1	 Ribbon cable display to MCBA		
13	257F1138	785789	1	Cabling HM85TC V13		

Bumer HM85TC





Burner HM85TC

Code	Code GA	Quant.	Picture	Description	From --- To ----	Remark
0	10800265	784436	1	 Kit mounting hardware condens.boilers		
1	557A0026	786570	1	 Gasket (cork) for venturi		
2	537D4033	786130	1	 Gaz valve VK8115V1036		
3	537D4037	786132	1	 Orifice 6,8mm (VF051 G31)		
4	557A0098	786597	1	 Gasket venturi-gas valve		
5	537D4028	786129	1	 Venturi VF051		
6	507F4283	786028	1	 Sight glass kit (monobloc)	01-08-13-	Prev: 507F4164
7	A1002432	786973	1	 Gasket burnerhead HMTC BO V15	01-10-12-	Prev: 557a0154- 557a0065
8	537DZ019	786448	1	 Burner head NIT 98x372		
10	A1005074	787431	1	 Insul.burner HM BO TC V15	16-08-18-	Prev: A1002431 - 51700126 - 557A0176
11	557A0163	786635	1	 Gasket électrode dual ceramic	01-04-13-	Prev: 557A0095
12	10800313	784486	1	 Kit électrode for HMTC large +screws+gask.	01-09-13-	incl.screws & gasket
13	257F1069	785758	1	 Ignition cable 1200mm HM201		
14	557A0054	786583	1	 Gasket fan Prest.		
15	537D3033	786096	1	 Fan RG148-3633 230V Prestige 75		
16	507F4103	785962	1	 Burner plate Prest.50-75 MK2		
17	557A0149	786623	1	 Gasket sight glass monobl (68x32x2 GPE)		