

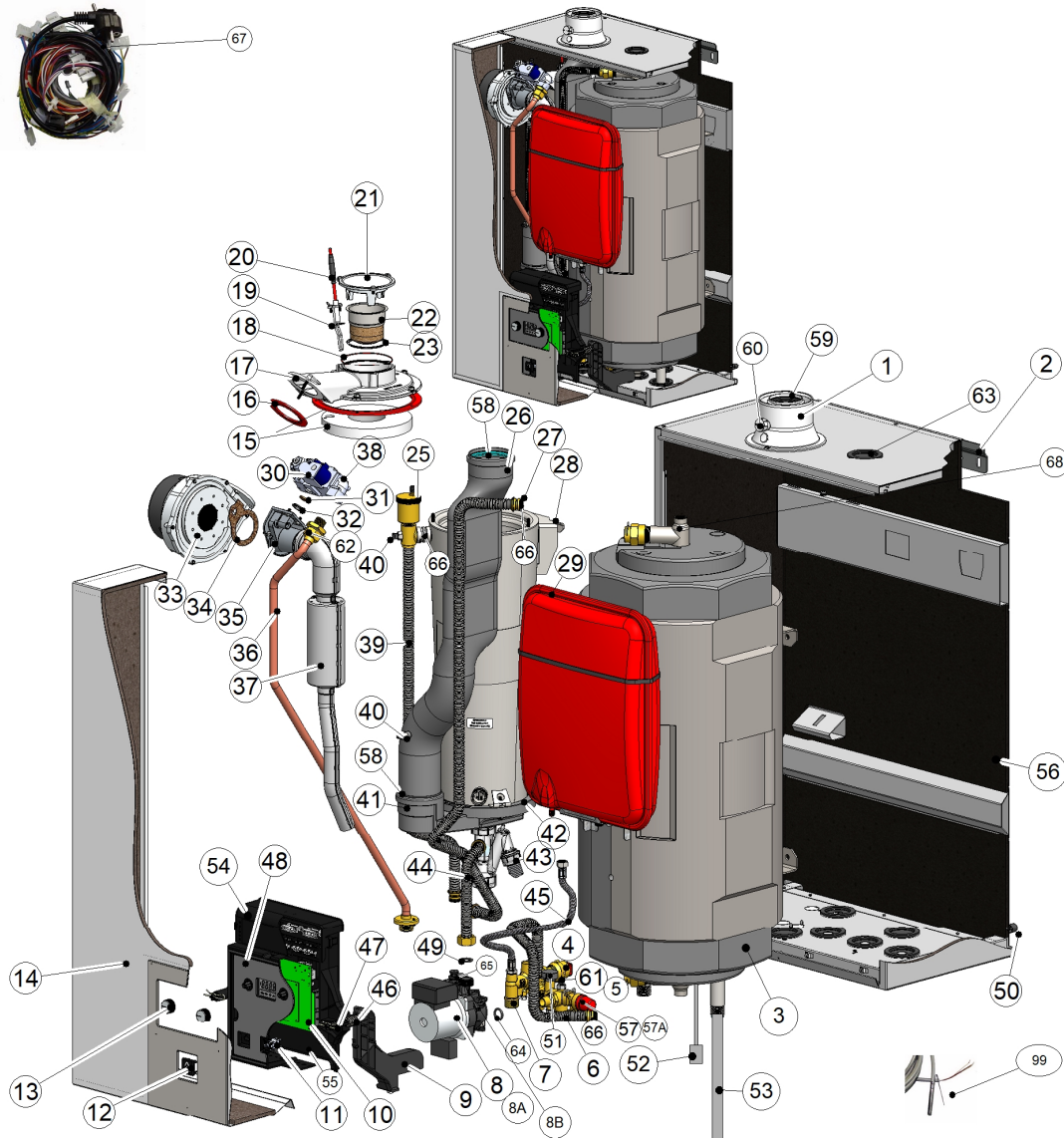

















Prestige 18-32 Exc.MK3

























Prestige 18-32 Exc.MK3

Code	Code GA	Quant.	Photo	Description	De --- A ---	Remarque
0	10800201	784419	0	 Clip-in ESYS-EBV		OPTION
0	10800265	784436	1	 Kit visserie chd.condens.		
0	557A0166	786636	1	 Set joints Prest.Solo-Exc 18-32 mk3	01-01-12-	
0	10800263	784434	1	 Kit entretien Prest.MK3	01-07-12-	
1	537D6401	786283	1	 Sortie fumée 60-100 Prest.	01-08-10-	
2	21480069	784696	1	 Fixation murale Prest.(S&E)	01-08-10-	
3	30539569	784786	1	 Ballon+isolation Prest.Exc.Mk3	01-08-10-	
4	5476v032	786549	1	 Stepper motor Hydrobloc Prest.MkIII	01-08-10-	
5	4372G011	785839	1	 Extension T 1/4- 1/8 hydrosmart	01-01-11-	with 5476G054
6	507F4204	786003	1	 Tube retour ballon P18-32.Exc.MK3	01-08-10-	
7	557A1061	786675	1	 Hydrosmart cpl Prest.Exc. Mk3	01-08-10-	
8A	557A4021	786705	1	 Circul.BSL12/4.1-3 CLF 12+o-ring+épingle	01-08-10-	18 kW
8	557A4022	786706	1	 Circul.BSL12/6-3 CLF 12+o-ring+épingle	01-08-10-	32 kW
8B	A1005093	787432	1	Epingle pour purgeur (circ.BSL)	01-04-18-	
9	5476V030	786548	2	 Support boitier Prest.Exc. 18-32 Mk3	01-08-10-	
10	5476g057	786525	1	 ESYS réglé Prest.Solo-Exc.18-32 Mk3	01-08-10-	
11	54766027	785239	1	 Interrupteur on/off 2P 16A/250VAC MK3	01-08-10-	
12	54766030	785241	1	 Capot interrupteur I/O Prest.V14	01-01-15-	prev: 54766029
13	54764028	785218	2	 Bouton rotatif Prest.Mk3	01-08-10-	
14	28473463	784758	1	Avant cpl Prest.Exc.MK3	01-08-10-	























Prestige 18-32 Exc.MK3

Code	Code GA	Quant.	Photo	Description	De --- A ---	Remarque
15	A1005069	787427	1	 Isol.brûleur 2en1 Prest.18-32 MK3	01-03-18-	Prev: A1003354 51700079 51700097 & 557a0123 557a0177
16	557A0119	786607	1	 Joint Ventil. Prest.32 MK3	01-08-10-	32 kW
16	557A0132	786613	1	 Joint+trou 22 Ventil. Prest.18	01-08-10-	18 kW
17	507F4188	785993	1	 Porte brûleur Prest.18-32 Mk3	01-08-10-	
18	557A0121	786608	1	 O-ring 95x2 silicone	01-08-10-	
19	557a0095	786595	1	 Joint électrode Prest.MK3	01-08-10-	
20	537DZ038	786460	1	 électrode P18-32 Mk3 céram.longue	01-01-12-	prev: 537DZ036
21	507F4189	785994	1	 Capot porte foyer alu Prest.18-32 MK3	01-08-10-	
22	537DZ035	786458	1	 Rampe Prest.18-32 Mk3 Propane	01-08-10-	Propane
22	537DZ042	786462	1	 Rampe Prest.18-32 GN (furipat)	01-01-13-	Nat Gas
23	557A0180	786642	1	 Joint rampe P18-32 (corde)	01-10-12-	Prev: 557a0122
25	557A3001	786695	1	 Purgeur air auto.1/2 laiton	01-08-10-	
26	497b6016	785911	1	 Tube fumée Prest.Exc.Mk3	01-08-10-	
27	507F4203	786002	1	 Tube départ ballon Prest.Exc. 18-32 Mk3	01-08-10-	
28	27300075	784739	1	 Echangeur P18-32 MK3 +bac condens.PP	01-01-12-	With Plastic condensate pan
29	557A7011	786726	1	 Vase expans.12L 3/8 Exc MK3-V14 s/pattes	01-08-10-	
30	537D4009	786121	1	 Vanne gaz VK4115V1014	01-08-10-	
31	537D4020	786126	1	 -OBS- Opercule 5,2mm->537D4082	01-08-10-	-Obsolete- 18 GN & 32 GP- HotSpot : 31
31	537D4057	786146	1	 Opercule 3,4mm (18kW VF055 G31)	01-08-10-	18 kW GP
32	557A0098	786597	1	 Joint vanne gaz-venturi	01-08-10-	



Prestige 18-32 Exc.MK3

Code	Code GA	Quant.	Photo	Description	De --- A ---	Remarque
33	537D3049	786109	1	 Ventil. RG128-1300-3612 230V	01-08-10-	
34	557A0026	786570	1	 Joint (liège) venturi	01-08-10-	
35	537D4034	786131	1	 Venturi VF002	01-08-10-	32 kW
35	537D4056	786145	1	 Venturi VF055	01-08-10-	18 kW
36	507F4200	785999	1	 Tube gaz Prest.Exc.MK3	01-08-10-	
37	537D4058	786147	1	 Silencieux Prest.18-32 Mk3	01-08-10-	
38	53402086	785025	1	 Bride coudée vanne gaz 1/2 +o-ring	01-08-10-	
39	507F4201	786000	1	 Tube départ Prest.Exc18-32 Mk3	01-08-10-	
40	5476g054	786524	2	 Sonde NTC 12K d5x50 1/8' +conn. Molex	01-08-10-	
41	497b4011	785891	1	 boîte à condensats plastique P32 MKIII	01-08-10-	
41	537D4068	786153	1	 Opercule dentelé fumées Prest.32 MK3	01-09-11-	32 kW only
42	A1002979	787054	1	 Joint o-ring Ø158,9xØ8,5 bac condens	01-10-16-	PREV 557A0126
43	47798012	784893	1	 Rondelle blocage siphon- Obsolete -	16-04-12-	
43	A1003132	787101	1	 Siphon DH50+bille+bague+joint	01-10-16-	PREV 557A8004
44	507F4202	786001	1	 Tube retour Prest.Exc18-32 Mk3	01-08-10-	
45	557A2014	786692	1	 Flexible vase expans.Prest.MK3	01-08-10-	
46	47796001	784889	2	 Ressort support boîtier Prest.Mk3	01-08-10-	
47	47792012	785848	7	 Goupille beta Ø2 DIN11024 simple AcZn	01-08-10-	
48	537d8138	786398	1	 Circ.impr.display LCD Prest.MK3		
49	557A0124	786609	1	 Joint EPDM 24x16x2.1 dureté 70 shore	01-08-10-	







Prestige 18-32 Exc.MK3

Code	Code GA	Quant.	Photo	Description	De --- A ---	Remarque	
50	4779z013	2		Butée 15mm appui Arrière Exc.MK3	01-08-10-		
51	507F4190	788149	1		Epingle fixation	01-08-10-	
51	5476V033	786550	1		Sonde de pression 0-4 bar 5250AB00	01-08-10-	
52	39438065	784830	1		Doigt de gant inox 1/2x250	01-08-10-	
53	497B0051	785865	1		Plonge PVCc 19,5x840 perç.lat.	01-04-12-	
54	54767026	785245	1		Cache bornier Prest.Mk3	01-08-10-	
55	497B4012		1		Couvercle Arrière boîtier élec Prest.Mk3	01-08-10-	
56	28471463		1		Caisson Arrière complet Prest.Exc.Mk3	01-10-12-	new spare
57A	557A1062	786676	1		Soupape secur.2,5bar UK Hydrosmart P.MK3		UK 2,5 bar
57	A1005375	787446	1		Soupape secur.3bar Hydrosmart P.MK3	01-05-18-	EU 3 bar
58	557A0105	786600	2		Joint à lèvres DN80 HR-EPDM noir	01-08-10-	
59	557A0137	786615	1		Joint à lèvres DN60 HR-EPDM noir	01-08-10-	
60	497B1051	785879	1		Bonnet prise mesure		
61	5476G047	786519	1		Sonde NTC 12K d5x18 1/8 +Molex conn.		
61	5476g054	786524	1		Sonde NTC 12K d5x50 1/8' +conn. Molex		if 4372G011 is used
62	557A0161	786633	1		Joint gaz 23,5x17x2 NBR 80 ShA EN682		
63	49430026	784905	1		Bouchon 61.3mm PVC noir (fine tôle)		
64	557A0152	786626	1		O-ring 17,04x3,53 pr.circ.Prest.MK3		
65	557A3006	786698	1		Purgeur air auto circul.Prest.MK3	01-04-14-	
66	557A0130	786611	5		O-ring 17,12x2,62 tubes flex Mk3		



Prestige 18-32 Exc.MK3

	Code	Code GA	Quant.	Photo	Description	De --- A ---	Remarque
67	257F1123	785780	1		Câblage Prest.18-32 Exc. Mk3	01-08-10-	
68	55445006	785282	1		Purgeur air man.1/2		
99	547D3018	786561	1		Sonde NTC 12K L1500 pour ballon	01-08-10-	