

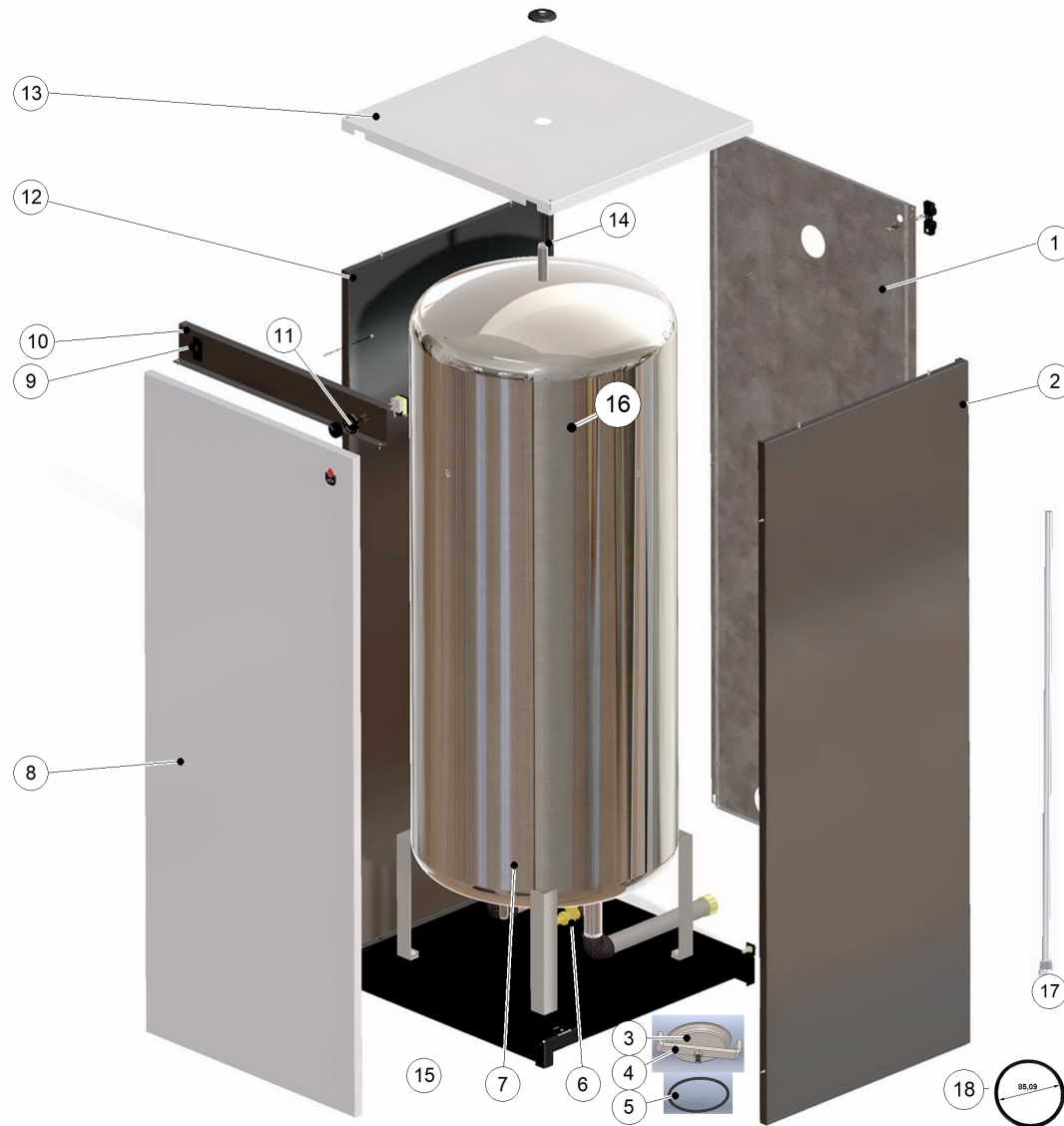





HRI 800



HRI 800

Code	Code GA	Quant.	Photo	Description	De --- A ---	Remarque	
1	20474492	784529	1		Arrière HRI800	01-05-13-	
2	21471492	784564	1		Lat.droit HRI800 (gris V13)	01-05-13-	
3	507F4255	786012	1		Plateau trou de main HRI	01-05-13-	
4	507F4256	786013	1		Etrier zingué trou de main HRI	01-05-13-	
5	557A0175	786637	1		O-ring 129,5x7 EPDM sanitaire	01-05-13-	
6	557A1000	786653	1		Robinet de vidange 3/4	01-05-13-	
7	30540588		1		Corps HRI800	01-05-13-	
8	21473492	784609	1		Avant HRI800	01-05-13-	
9	54403000	785128	1		Thermomètre vertical cap3000 IC021999	01-05-13-	
10	21477492	784672	1		Tableau (tôle) HRI800	01-05-13-	
11	54764021	785212	1		Bouton rotatif thermostat-trait blanc	01-05-13-	
11	A1004760	787386	1		T-stat 10-85°C cap3000 bulb6 TU-L-DT	01-01-18-	
12	21472492	784584	1		Lat.gauche HRI800 (gris foncé)	01-05-13-	
13	21475492	784640	1		Couvercle HRI800	01-05-13-	
14	55445006	785282	1		Purgeur air man.1/2	01-05-13-	
15	497B0029	785858	1		Plonge PVCC 39,5x1750	01-05-13-	
16	51432009	784976	1		Laine de roche REF126 1200x60 RL:6m	01-05-13-	
17	39438039	784823	1		Doigt de gant inox 1/2x750	01-05-13-	
18	55412071	785272	1		O-ring 85x5,33 EPDM sanitaire		prod date from 01/12/2014