

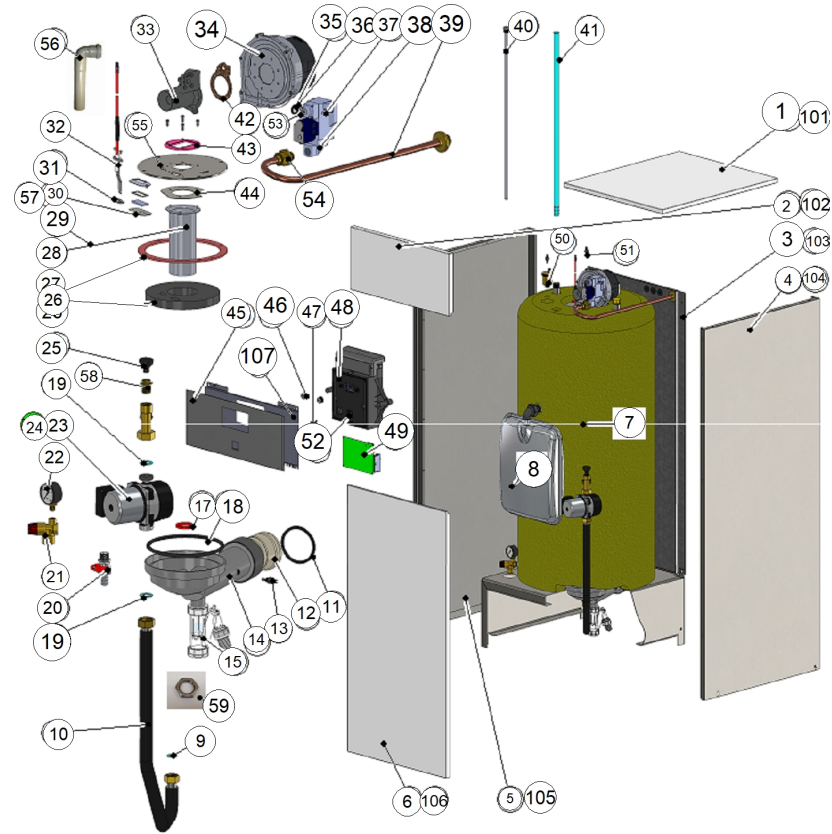





























HM25C V13





















Code	Code GA	Quant.	Photo	Description	De --- A ---	Remarque
0	10800265	784436	1	 Kit visserie chd.condens.		
1	21475468		1	Couvercle HM25C		
2	21478468		1	Avant sup. HM25C		
3	21474468		1	Arrière HM25C		
4	21471468	784557	1	Lat.droit HM25C (gris clair)		
5	21472468		1	Lat.gauche HM25C (gris clair)		
6	21473468	784602	1	Avant HM25C		
7	30540570	784807	1	Corps moussé HM25 C		
8	557A7008	786725	1	 Vase expans.12L 3/4		
9	557A0051	786581	1	 Joint 24x14x2 fibre		
10	507F4208		1	 Tube de circulateur HM25C		
11	557A0105	786600	1	 Joint à lèvres DN80 HR-EPDM noir		
12	537D6404	786286	1	 Coude 30° MF DN80 PP gris+joint		
13	5476g054	786524	1	 Sonde NTC 12K d5x50 1/8' +conn. Molex		
14	10800261	784432	1	 Bac condens.PPS+joints HM35TC-25 C		
15	A1003132	787101	1	 Siphon DH50+bille+bague+joint		
17	A1004464	787332	1	Joint 28-45x4 Viton bac condens.HMTC		
18	557A0141	786618	1	 Joint DI:166 bac.condens.HM35TC		
19	557A0050	786580	1	 Joint 30x20x2 fibre		
20	55426001	785274	1	 Robinet de vidange 1/2		

Code	Code GA	Quant.	Photo	Description	De --- A ---	Remarque
21	55426017	785275	1	 Soupape secur.3bar 1/2 50kW		
22	54426002	785129	1	 Manomètre 1/4 vertical réf.9013989		
23	557A4014	786702	1	 Circul.RS15/6-3KU CLF L130-6 G1 Molex		NON ERP
24	A1006375	780155	1	Assemblage UPM3 15-60 L 130 G1 & Connect	29-10-19-	ERP- prev : A1002167
25	5476V033	786550	1	 Sonde de pression 0-4 bar 5250AB00		
26	A1005072	787430	1	 Isol.brûleur Pioneer HM SO TC V15	-21-08-18	2in1insulation - prev: A1002429 - 51700128&557a0179
28	537DZ025	786451	1	 Rampe Prest.24-32 GN D:63 L:157,9		Nat Gas
29	537DZ026	786452	1	 Rampe NIT NIT Prest.D63 L158		Propane
30	507F4283	786028	1	 Kit regard flamme monobloc		prev 507f4164
31	557a0095	786595	1	 Joint électrode Prest.MK3		
32	537DZ038	786460	1	 électrode P18-32 Mk3 céram.longue		Prev 537dz036
33	537D4034	786131	1	 Venturi VF002		
34	537D3049	786109	1	 Ventil. RG128-1300-3612 230V		
35	557A0098	786597	1	 Joint vanne gaz-venturi		
36	537D4020	786126	1	 -OBS- Opercule 5,2mm- >537D4082		-Obsolete-Propane- HotSpot : 36
37	537D4009	786121	1	 Vanne gaz VK4115V1014		
38	53402086	785025	1	 Bride coudée vanne gaz 1/2 +o-ring		
39	507F4206	786004	1	Tube gaz HM25C		
40	39438027	784821	1	 Doigt de gant inox 1/2x500		
41	49410045	784899	1	 Plonge PVCc 19,5x800 ouverte		



## HM25C V13

	Code	Code GA	Quant.	Photo	Description	De --- A ---	Remarque
42	557A0026	786570	1		Joint (liège) venturi		
43	557A0054	786583	1		Joint bride ventil.Prest.		
44	A1002430	786971	1		Joint rampe brûleur HMTC PV V15		prev 557a0048-557A0153
45	21476468	784658	1		Panneau inox HM25C		
46	54764028	785218	1		Bouton rotatif Prest.Mk3		
47	54766030	785241	1		Capot interrupteur I/O Prest.V14		prev 54766029
48	537d8138	786398	1		Circ.impr.display LCD Prest.MK3		
49	5476g058	786526	1		ESYS réglé HM25C		
50	557A3001	786695	1		Purgeur air auto.1/2 laiton		
51	5476G047	786519	1		Sonde NTC 12K d5x18 1/8 +Molex conn.		
52	54766027	785239	1		Interrupteur on/off 2P 16A/250VAC MK3		
53	53437039	785089	1		Prise de pression D:8,5 M5		
54	557A0161	786633	1		Joint gaz 23,5x17x2 NBR 80 ShA EN682		
55	507F4095	785961	1		Plaque brûleur Prest.24-32 HMTC		
56	497B0025	785854	1		Silencieux Prest.24-32-50-75 MK2		
57	557A0149	786623	1		Joint regard flamme monobl(68x32x2 GPE)		
58	507F4207	786005	1		Raccord+epingle capteur pression HM25C		
59	4779A011	785844	1		Ecrou 3/4 DIN431A inox HMTC		
99	257F1125	785781	1		Câblage HM25 C		
99	547D3018	786561	1		Sonde NTC 12K L1500 pour ballon		



HM25C V13

	Code	Code GA	Quant.	Photo	Description	De --- A ---	Remarque
101	21475489	784638	1		Couvercle HM25C V13		
102	21478489	784682	1		Avant sup. HM25C V13		
103	21474489		1		Arrière HM25C V13		
104	21471489	784561	1		Lat.droit HM25C (BLANC)		
105	21472489	784581	1		Lat.gauche HM25C (BLANC)		
106	21473489	784606	1		Avant HM25C V13		
107	20477468		1		Tableau (tôle) HM25C		