

Panels HM100N

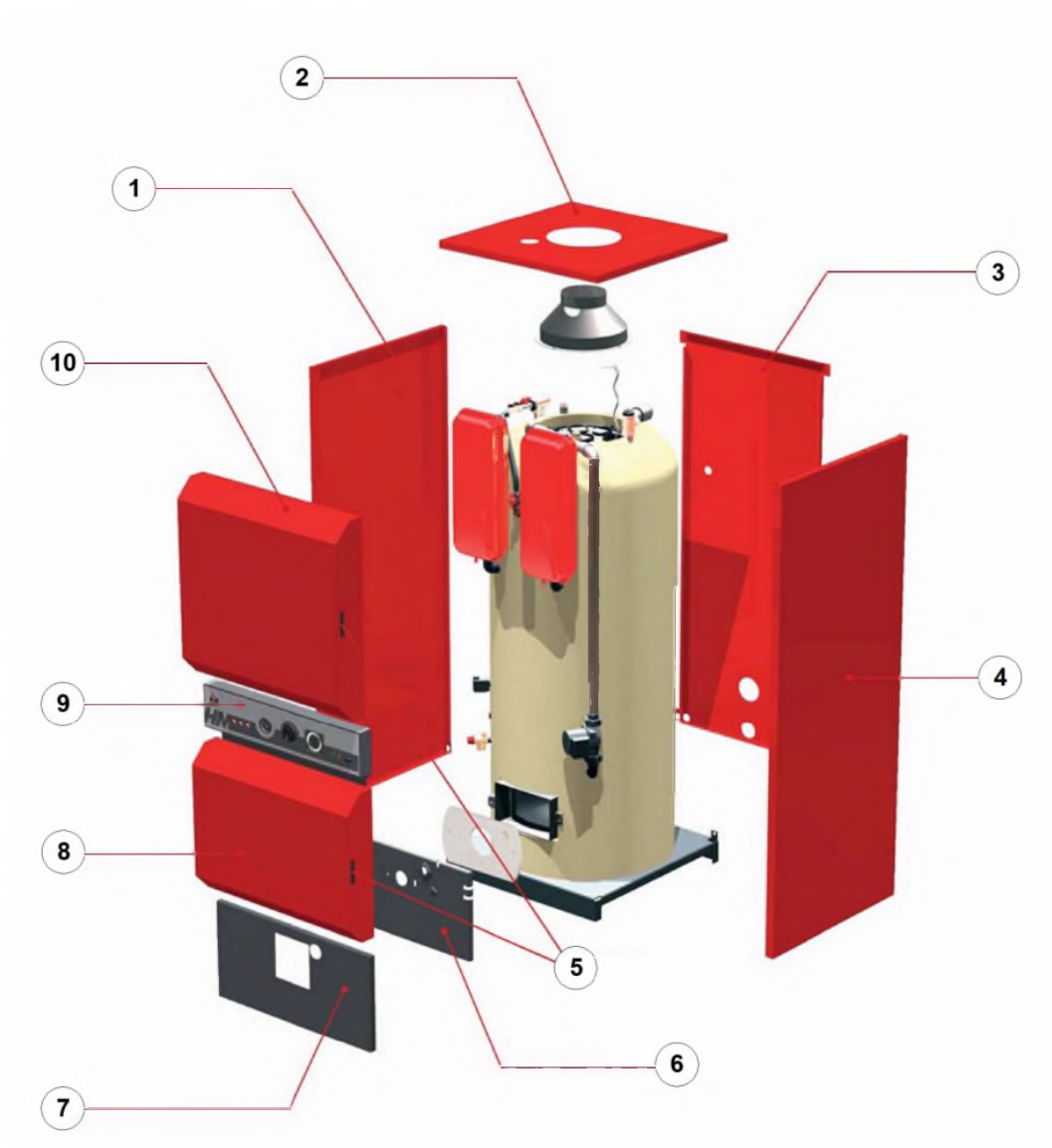



Panels HM100N





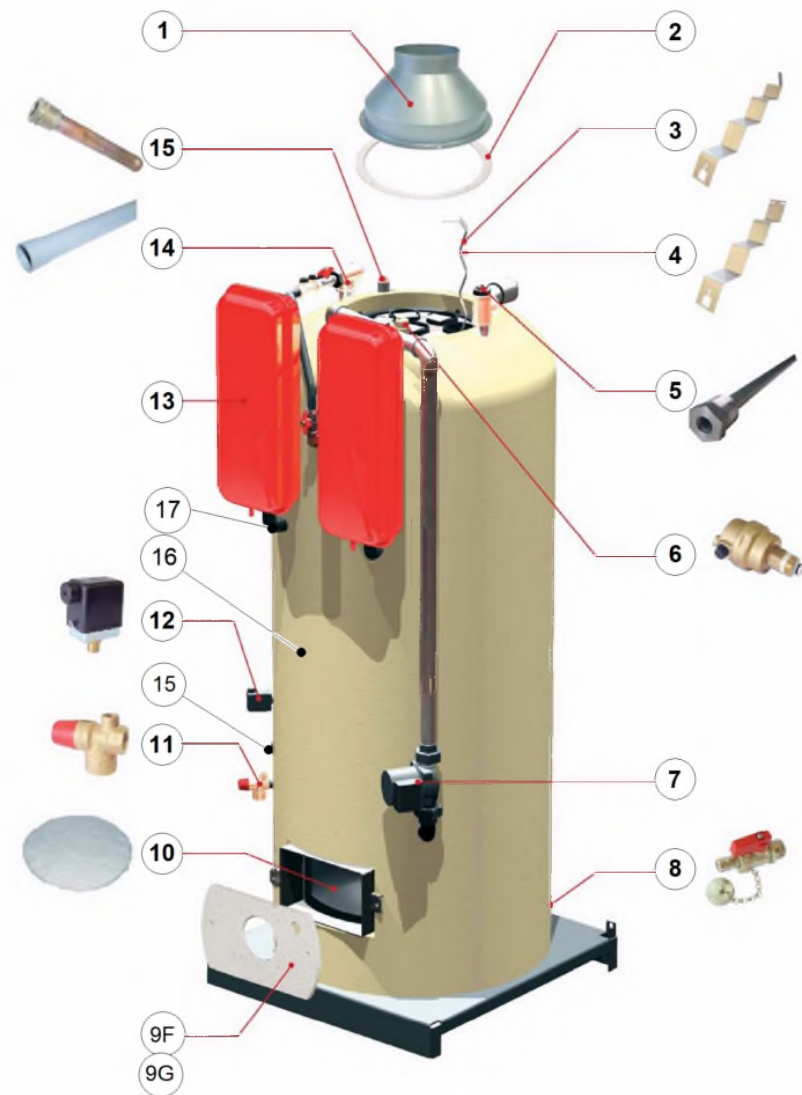









№	Code	Code GA	Quant.	Picture	Description
1	21472370		1		Side panel LH HM100-101 (red)
2	21475369		1		Top panel HM70-71-100-101 (red)
3	21474370		1		Rear panel HM100-101 (red)
4	21471370		1		Side panel RH HM100-101 (red)
5	49410280	784904	2		Handle for cover (HD PE)
6	2147P152	785720	1		Burner door HM70-100
7	21476370		1		Burner door cover HM70-100 (grey)
8	21478369		1		Front panel lower HM70-71-100-101 (red)
9	21477369		1		Control panel HM70-100 (plate only)
10	21473370		1		Front panel upper HM100-101 (red)

Internal HM100N









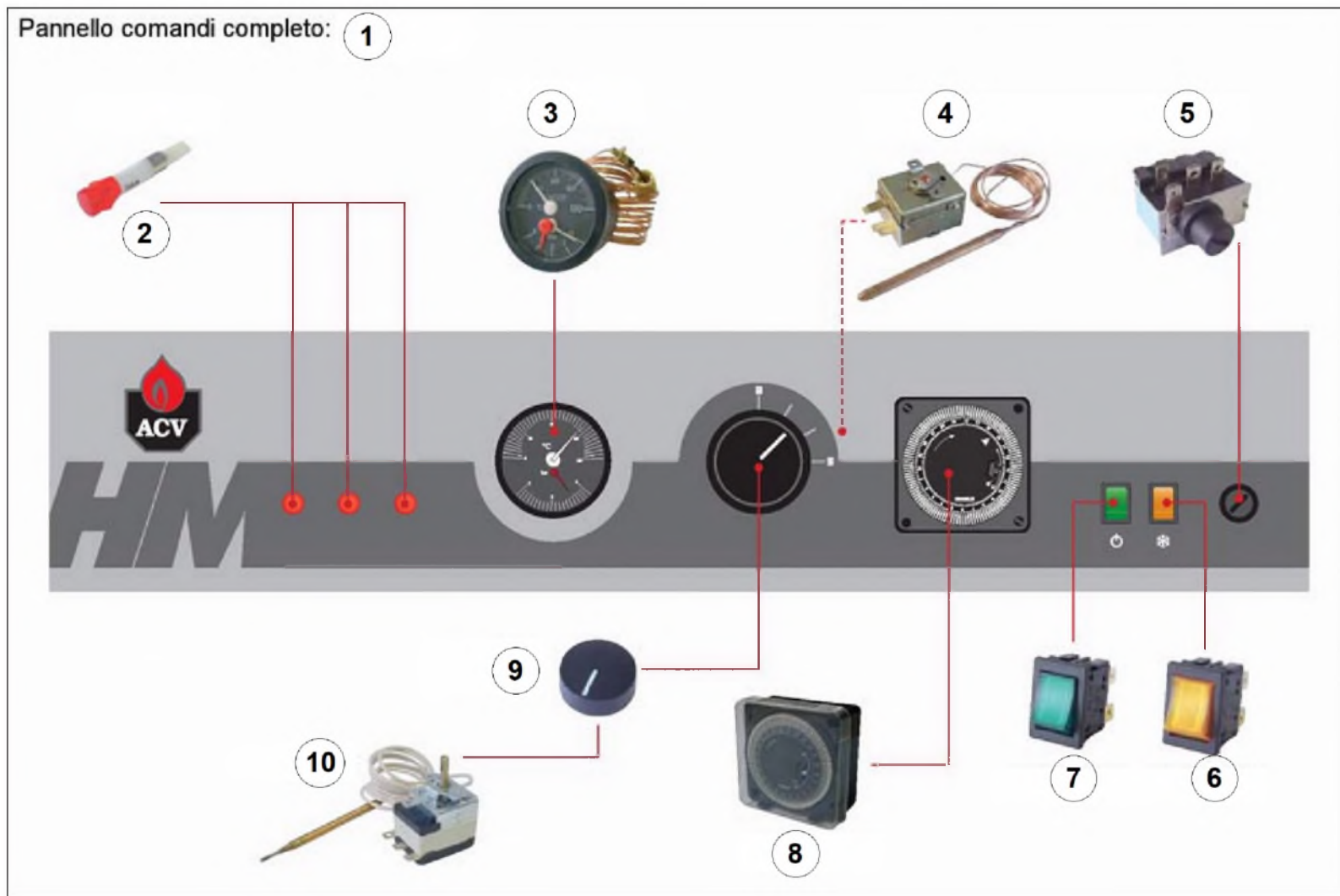



Internal HM100N

Code	Code GA	Quant.	Picture	Description	From --- To ----	Remark
1	507F3033	785935	1	 Flue hood 290- >DN150 mm F45/HM		
2	557A0156	786630	1	 Gasket draft hood De:325 Di:290 Dh:310	01-10-12-	Prev: 557A0016
3	507F2009	785930	8	 Turbulator upper HM type A		
4	507F2010	785931	24	 Turbulator lower HM type B		
5	39438047	784825	1	 Dry well SST 1/2x1200		
6	55445007	785283	1	 Air vent auto.3/8 with non-ret.valve		
7	557A4009	786700	1	 Pump RS25/6-3 L130-3 G6/4		
8	55426001	785274	1	 Drain cock 1/2		
9G	51700103	784996	1	 Insul.burner door BG2000 HM100- 101		Gas
9F	A1003520	787214	1	 2 in 1 insulation HM30-60-100 Delta	01-10-12-	Prev: 51700101
10	51700093	784989	1	 Insul.blanket D430x13 - 128kg/m³	01-10-12-	prev: 51305000
11	557A1076	786682	1	 Safety valve 3bar 100kW 1/2	01-02-13-	prev: 55426017
12	A1003191	787140	1	 Kit pressure switch 220V (prev: 557a1056)	01-08-16-	
13	557A7006	786723	2	 Exp.vessel 10L CH		
14	49410071	784901	1	Sparge tube PVCc 25x1350 unplug.		
15	63438001	785296	2	 Dry well brass 1/2x100 3 bulbs		
16	A1005756		1	Body with insulation HM100- 101 (V13)		Prev:30540368
17	42716007	784844	2	Rotary elbow mf3/4 fig.97 steel		





Control panel HM100N

Code	Code GA	Quant.	Picture	Description	From --- To ----	Remark	
1	24614205	784719	1		Contr.pan.cpl HM70-100 (V13)	01-09-13-	
2	54766001	785226	3		Light red D10 230V		
3	025007		1		Combined T°/Manometer 0-4 bar 0-120°C		Prev : 54441008 - Tableau électrique
4	025005		1		T-stat 95°C cap1610 bulb6 TU-L-DT		Prev : 54322000 - Tableau électrique
5	54764006	785207	1		T-stat+reset 103°C cap3060bulb6 TS-RM-DT		
6	54766017	785235	1		Switch 2P yellow		
7	54766016	785234	1		Switch 2P green		
8	54452000	785178	1		Timer Grässlin with switch		
9	54764021	785212	1		Knob for T-stat, white line		
10	025006		1		T-stat 0-90°C cap1500 bulb6 TU-L-DT		Prev : 54442045 - Tableau électrique