

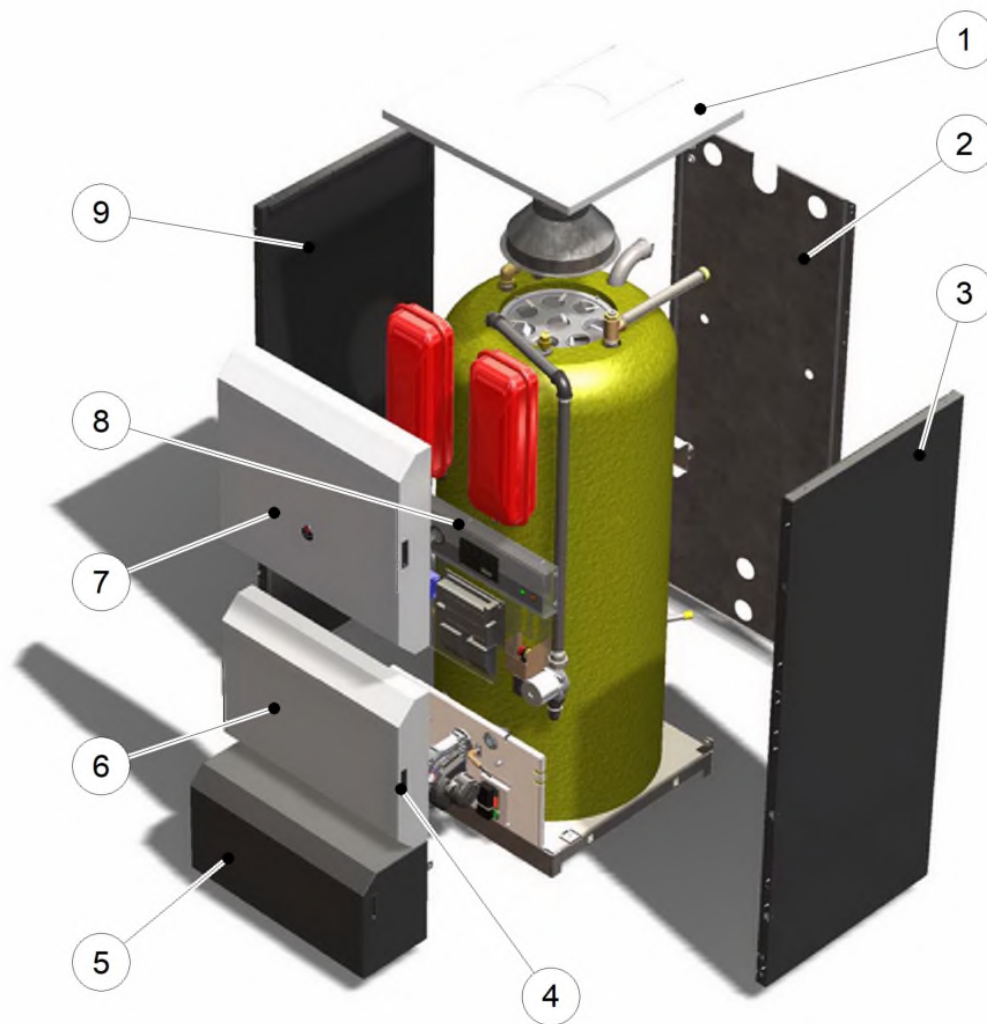

Panels HM71 V13





Panels HM71 V13





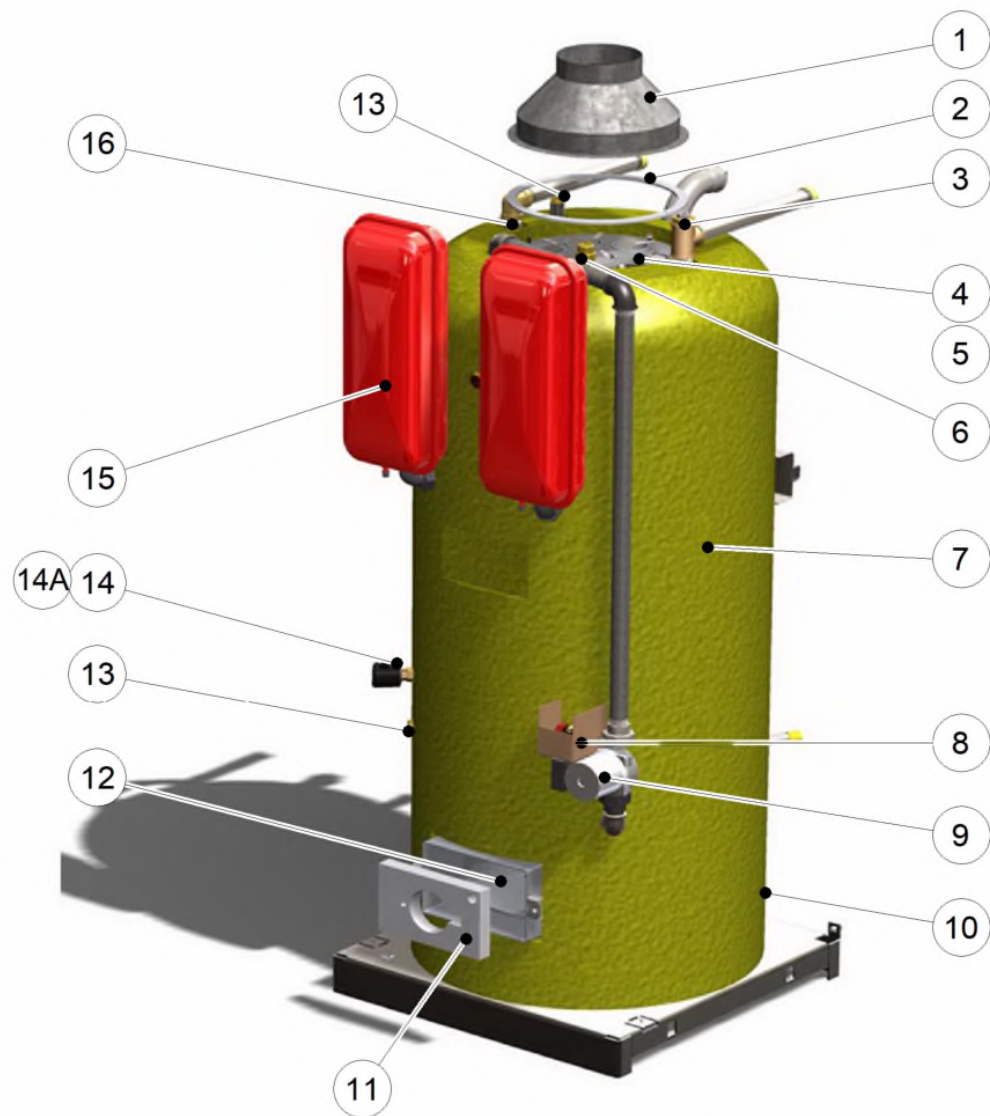









Code	Code GA	Quant.	Picture	Description	From --- To ----	
1	21475496	784642	1		Top panel HM70-71-100-101 (white V13)	01-11-13-
2	20474496	784532	1		Rear panel HM70-71 (galva V13)	01-11-13-
3	21471496	784566	1		Side panel RH HM70-71 (grey V13)	01-11-13-
4	49410280	784904	6		Handle for cover (HD PE)	01-11-13-
5	21476496		1		Burner cover HM71-101 (Grey V13)	01-11-13-
6	21473497	784611	1		Front panel lower HM70-71-100-101 white	01-11-13-
7	21478496	784683	1		Front panel upper HM70-71 (white V13)	01-11-13-
8	21477496		1		Control panel HM71-101 V13 (plate only)	01-11-13-
9	21472496	784586	1		Side panel LH HM70-71 (grey V13)	01-11-13-

Internal HM71 V13





Internal HM71 V13

Code	Code GA	Quant.	Picture	Description	From --- To ----	Remark
1	507F3033	785935	1	 Flue hood 290- >DN150 mm F45/HM	01-11-13-	
2	557A0156	786630	1	 Gasket draft hood De:325 Di:290 Dh:310	01-11-13-	
3	39438046	784824	1	 Dry well SST 1/2x950	01-11-13-	
4	507F2009	785930	8	 Turbulator upper HM type A	01-11-13-	
5	507F2010	785931	16	 Turbulator lower HM type B	01-11-13-	
6	55445007	785283	1	 Air vent auto.3/8 with non-ret.valve	01-11-13-	
7	30540603		1	Body foamed HM70-71 (V13)	01-11-13-	
8	557A1076	786682	1	 Safety valve 3bar 100kW 1/2	01-11-13-	
9	557A4009	786700	1	 Pump RS25/6-3 L130-3 G6/4	31-07-15-31-12-19	non ERP
9A	A1007650	780435	0	ASSEMBLY UPM3 AUTO 25-70 L130 &CONNECTOR	29-10-19-	ERP - prev : 557A4033 -prev A1006374
10	55426001	785274	1	 Drain cock 1/2	01-11-13-	
11	51700103	784996	1	 Insul.burner door BG2000 HM100- 101	01-11-13-	
12	51700093	784989	1	 Insul.blanket D430x13 - 128kg/m³	01-11-13-	
13	63438001	785296	1	 Dry well brass 1/2x100 3 bulbs	01-11-13-	
14	557A1056	786672	1	 -OBS- Low pressure switch 1/4 0,5-0,8 bar	01-11-13-31-12-15	Prev : 557A1056
14A	A1002747	787022	1	 Low press.switch 1/4 CEME	01-01-16-	
15	557A7006	786723	2	 Exp.vessel 10L CH	01-11-13-	
16	497B0001	910423	1	Sparge tube PVCc 25x950	01-11-13-	

Control panel HM71

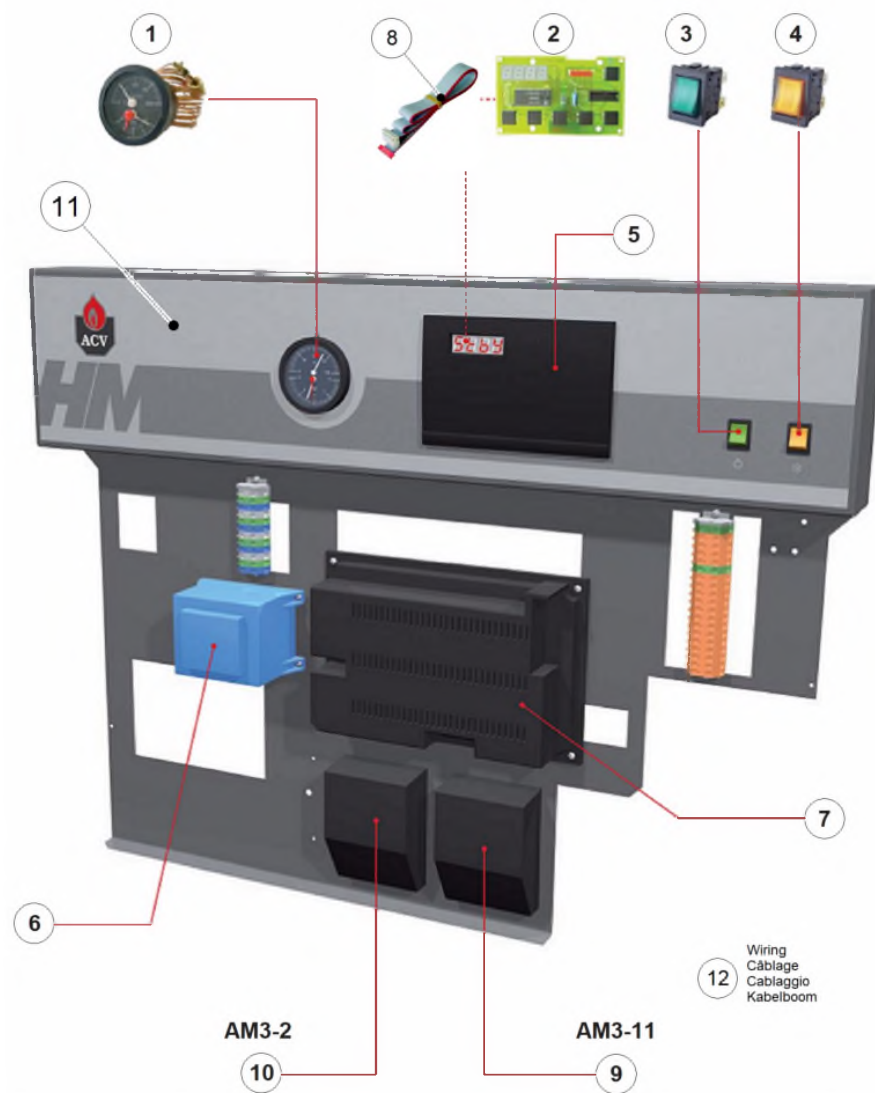



Control panel HM71

Code	Code GA	Quant.	Picture	Description	From --- To ----	Remark
1	025007	1		Combined T°/Manometer 0-4 bar 0-120°C		Prev : 54441008 -Tableau électrique
2	537D3020	786091	1		Display for MCBA	
3	54766016	785234	1		Switch 2P green	
4	54766017	785235	1		Switch 2P yellow	
5	537D3023	786092	1		Display box Hoval EBV 16.9910906013	
6	547D3021	786562	1		Transfo.230/24V 72VA+ cable 35cm MCBA	
7	537D8037	786378	1		MCBA preset for HM71	
8	257F1079	785764	1		Ribbon cable display to MCBA	
9	10800095	784375	1		Kit second heating circuit AM3-11	OPTION
10	10800094	784374	1		Kit alarm module AM3-2	OPTION
11	24614113	784707	1		Contr.pan.cpl HM101	-01-11-13
11	24614206	784720	1		Contr.pan.cpl HM71-101 (V13)	01-11-13-
12	257F1109		1		Cabling HM71-101	-01-11-13

Bumer HM71

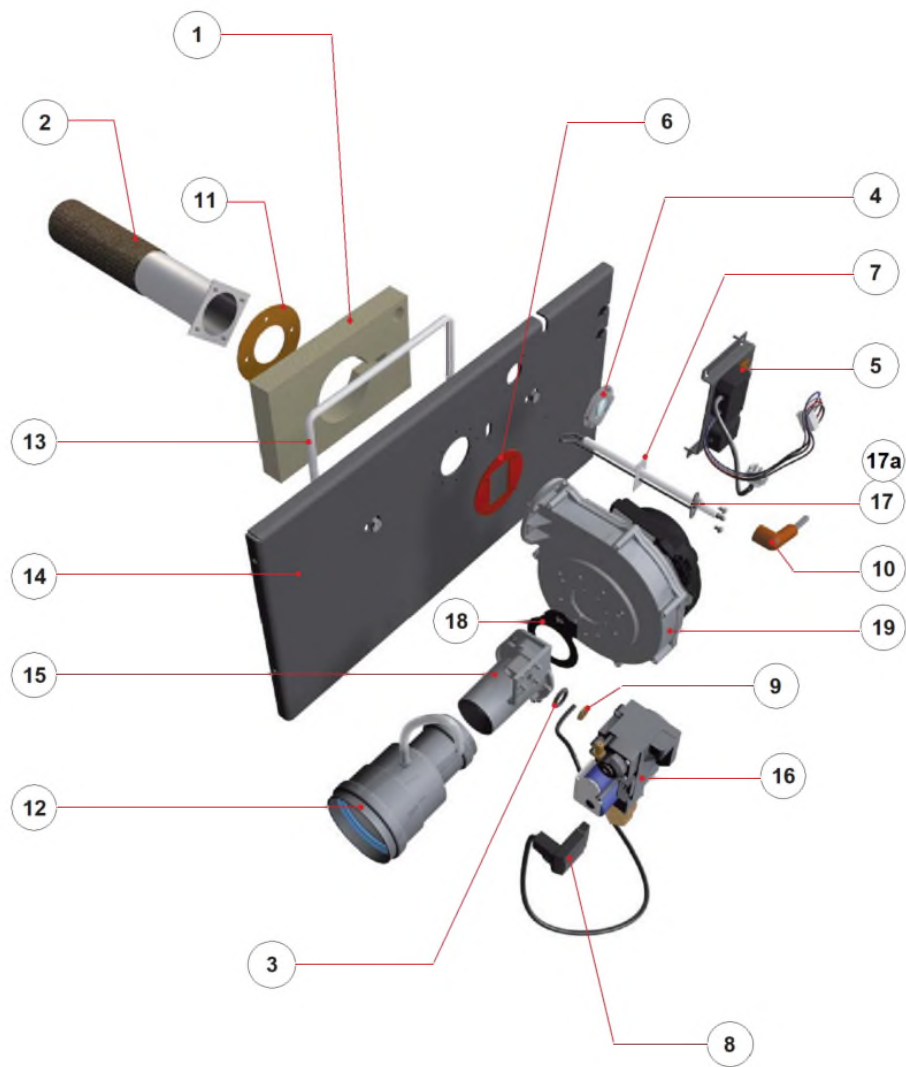





Burner HM71

Code	Code GA	Quant.	Picture	Description	From --- To ----	Remark
51700034		1		OBS- Insul.door BG2000 60-70-71 + USA	-31-08-09	- Obsolete - HotSpot n°1
1 51700102	784995	1		Insul.burner door BG2000 Delta Pro-HM	01-10-12-	Prev: 51700078
2 537DZ029	786455	1		Burner head NIT D:63 L:313,5 HM		
3 557A0098	786597	1		Gasket venturi-gas valve		
4 50423365	784922	1		Sight glass Furigas (assembly)		
4 557A0155	786629	1		Gasket kerlane Ø44x28x2	01-10-12-	Prev: 55412000
5 257F1108	785776	1		Cabling burner HM71		
6 55700026	785284	1		Gasket for fan BG2000		
7 557A0163	786635	1		Gasket électrode dual ceramic	01-10-12-	Prev: 557A0012
8 537D3016	786089	1		Rectifier 24V 45900446.051B		
9 537D4037	786132	1		Orifice 6,8mm (VF051 G31)		
10 257F1071	785759	1		Ignition cable 780mm Prest.		Prev : 257F1073 Tableau électrique
11 55700028	785285	1		Gasket burner tube BG2000 (Ø107x1mm)	01-10-12-	Prev: 55412000
12 537D6135	786190	1		Reducer FF 80x50 for air inlet		
13 51700025	784980	1		Cord D:10mm (per meter)		
14 21479369	784688	1		Burner door HM71		
15 537D4028	786129	1		Venturi VF051		
16 537D4033	786130	1		Gaz valve VK8115V1036		
17a 537DX029	786438	1		électrode 215-15-LH dual ceram.	-01-01-13	V09 only
17 537DX032	786440	1		électrode 185-10-LH dual ceram.	01-01-13-	from V013



Bumer HM71

Code	Code GA	Quant.	Picture	Description	From --- To ----	Remark
18	557A0026	786570	1	 Gasket (cork) for venturi		
19	537D3027	786095	1	 Fan RG148-1200-3612 without potent.		