

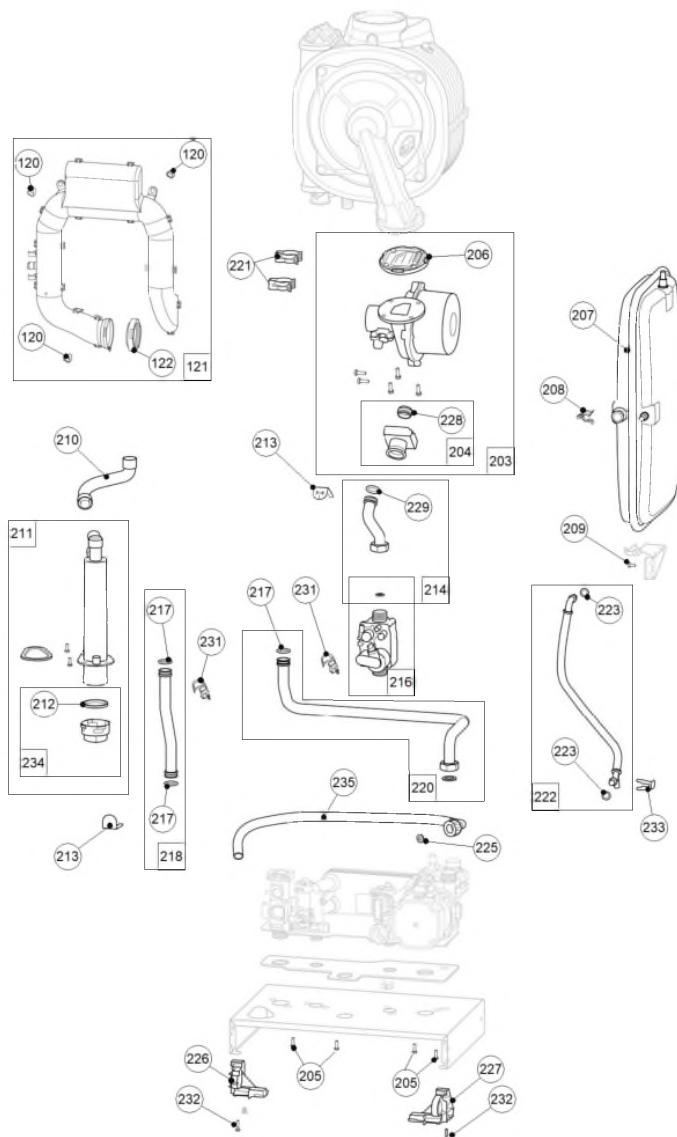











Boiler









Boiler

Code	Code GA	Quant.	Photo	Description	De --- A ---	Remarque
120	122208	3		Écrou pour silencieux	15-02-22-	
121	974404	1		Silencieux + joint & écrous	15-02-22-	
122	142289	7		Joint silencieux	15-02-22-	
163	142442	1		Joint 3/4-20/27	15-02-22-	
173	182566	182566		Coude (gaz) / Bocht (gas) / Winkelstück (Gas)	15-02-22-	
203	988532	1		Ventilateur joints et adaptateur 30	15-02-22-	20/25/30kw
204	900328	1		Adaptateur venturi + joint	15-02-22-	
205	190045	4		Vis tôle	15-02-22-	TX20
206	142291	1		Joint clapet	15-02-22-	
207	188276	1		Vase expansion 7L	15-02-22-	7l - > 18/25
207	188277	1		Vase expansion 8L	15-02-22-	8l - > 22/30
208	110386	1		Clips de vase	15-02-22-	
209	190037	1		Vis 40x9,5 TORX	15-02-22-	40x9,5 TORX
210	182517	1		Tube évacuation	15-02-22-	
211	976009	1		Siphon	15-02-22-	
212	142203	1		Joint siphon	15-02-22-	
213	100187	2		Agrafe D18	15-02-22-	D18
214	982019	1		Tube gaz + joints	15-02-22-	
216	988117	988117		Vanne gaz + joint / Gaskraan + dichting / Gasventil + Dichtung	15-02-22-	
217	142716	3		Joint 18x2,8	15-02-22-	ø int. 18x2,8



Boiler

Code	Code GA	Quant.	Photo	Description	De --- A ---	Remarque
218	982600	1		Tube départ + joints 3+1	15-02-22-	3+1 -> 22/30
218	982601	1		Tube départ + joints 2+1	15-02-22-	2+1 -> 18/25
219	142442	5		Joint 3/4-20/27	15-02-22-	3/4 - 20/27
220	982611	1		Tube retour + joints	15-02-22-	
221	110354	2		Clip	15-02-22-	
222	982018	1		Flexible de vase + joints	15-02-22-	
223	142717	2		Joint torique 9,5x2,7	15-02-22-	9,5x2,7
225	142218	1		Joint plat	15-02-22-	
226	174517	1		Pivot coffret gauche	15-02-22-	
227	174516	1		Pivot coffret droit	15-02-22-	
228	142292	1		Joint venturi	15-02-22-	
229	142795	1		Joint torique 7,04x3,53 Ilea	15-02-22-	17,04x3,53
231	198798	2		Sonde température DIA 18	15-02-22-	ø 18
232	190048	2		Vis EJOT 40X16	15-02-22-	40x16
233	100185	1		Agrafe D10	15-02-22-	D10 LG
234	943051	1		Bouchon + joint siphon / Stop + dichting sifon / Stopfen + Siphondichtung	15-02-22-	
235	183355	1		Flexible évacuation soupape	15-02-22-	



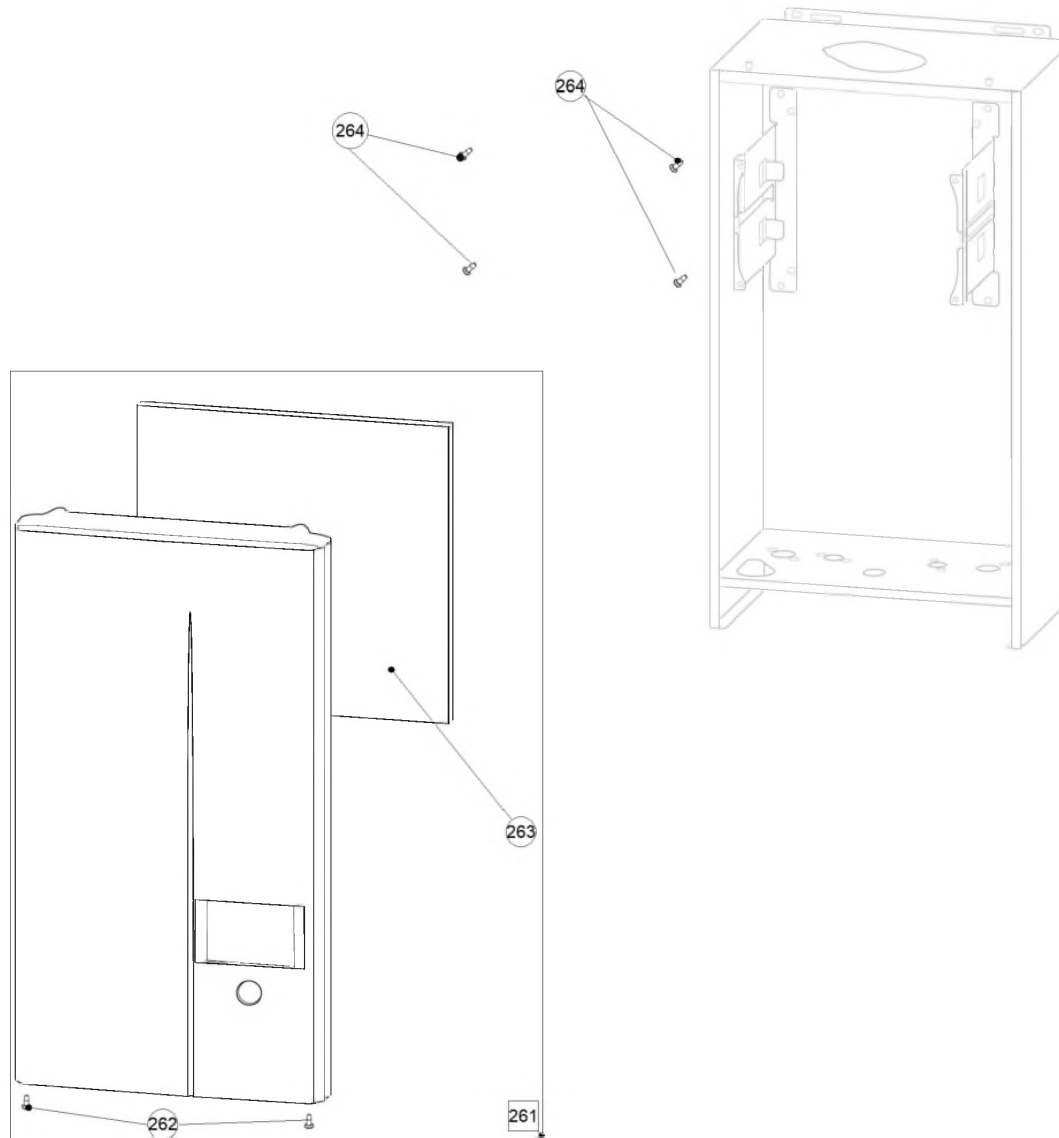

Casing





Casing

Code	Code GA	Quant.	Photo	Description	De --- A ---	Remarque
176	174511	2		Support mural	15-02-22-	
261	937401	937401	1	Façade ILEA SOLO + mousse / Voorkant ILEA SOLO + schuim / Vorderseite ILEA SOLO + Schaum	15-02-22-	Ep. 20
262	190049	2		Vis M4x12	15-02-22-	M4x12
263	141127	1		Mousse façade 20mm	15-02-22-	Ep. 20
264	190037	4		Vis 40x9,5 TORX	15-02-22-	Torx

Bumer + heat exchanger

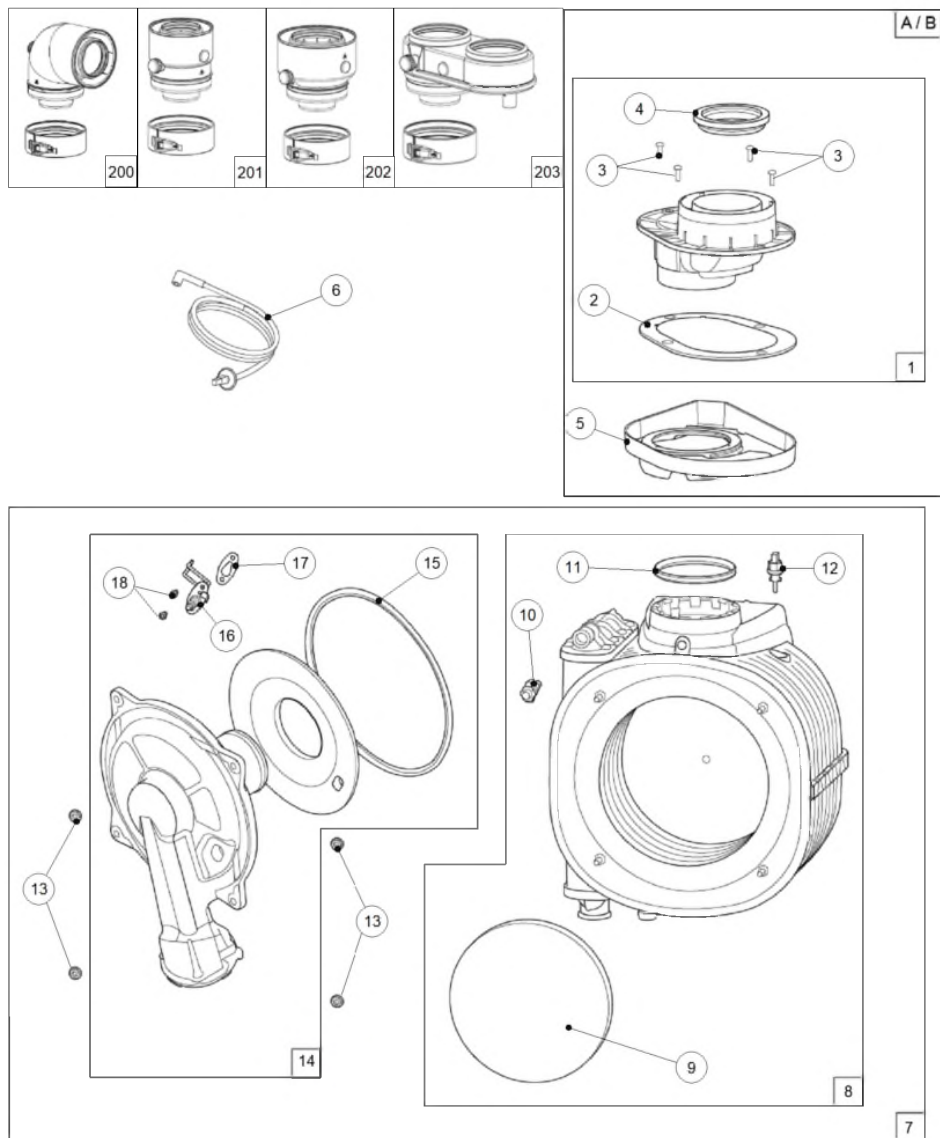



Burner + heat exchanger

Code	Code GA	Quant.	Photo	Description	De --- A ---	Remarque
1	900598	1		Adaptateur fumées	15-02-22-	
2	141187	1		Mousse adaptateur BE	15-02-22-	
3	190045	4		Vis tôle	15-02-22-	
4	142224	1		Joint adaptateur	15-02-22-	
5	164561	1		Récupérateur eau pluie	15-02-22-	
6	109129	1		Câble d'allumage	15-02-22-	
7	122053	1		Échangeur + brûleur 3+1	15-02-22-	
8	122051	1		Échangeur 3+1	15-02-22-	
9	140641	1		Isolant déélecteur	15-02-22-	
10	159063	1		Purgeur manuel	15-02-22-	
11	142476	1		Joint sortie échangeur d,80	15-02-22-	
12	198787	1		Sonde sécurité fumée	15-02-22-	
13	122215	4		Écrou M6X1	15-02-22-	
14	159021	1		Porte froide brûleur 3+1	15-02-22-	
15	142525	1		Joint porte froide	15-02-22-	
19	141036	1		Isolant porte froide	15-02-22-	
50	923007	1		Électrode d'allumage - ionisation + Joint + Vis / Ontstekings- en ionisatie-elektrode + Dichting + Schroef / Zünd- und Ionisationselektrode + Dichtung +Schraube	15-02-22-	
194	160025	1			15-02-22-	
200	A1007122	780267	1	Coude 90 °+ orifice -Ø (60/100) + Collier de serrage	15-02-22-	780267
201	A1007123	780268	1	Adaptateur + orifice -Ø (60/100) + Collier de serrage	15-02-22-	780268









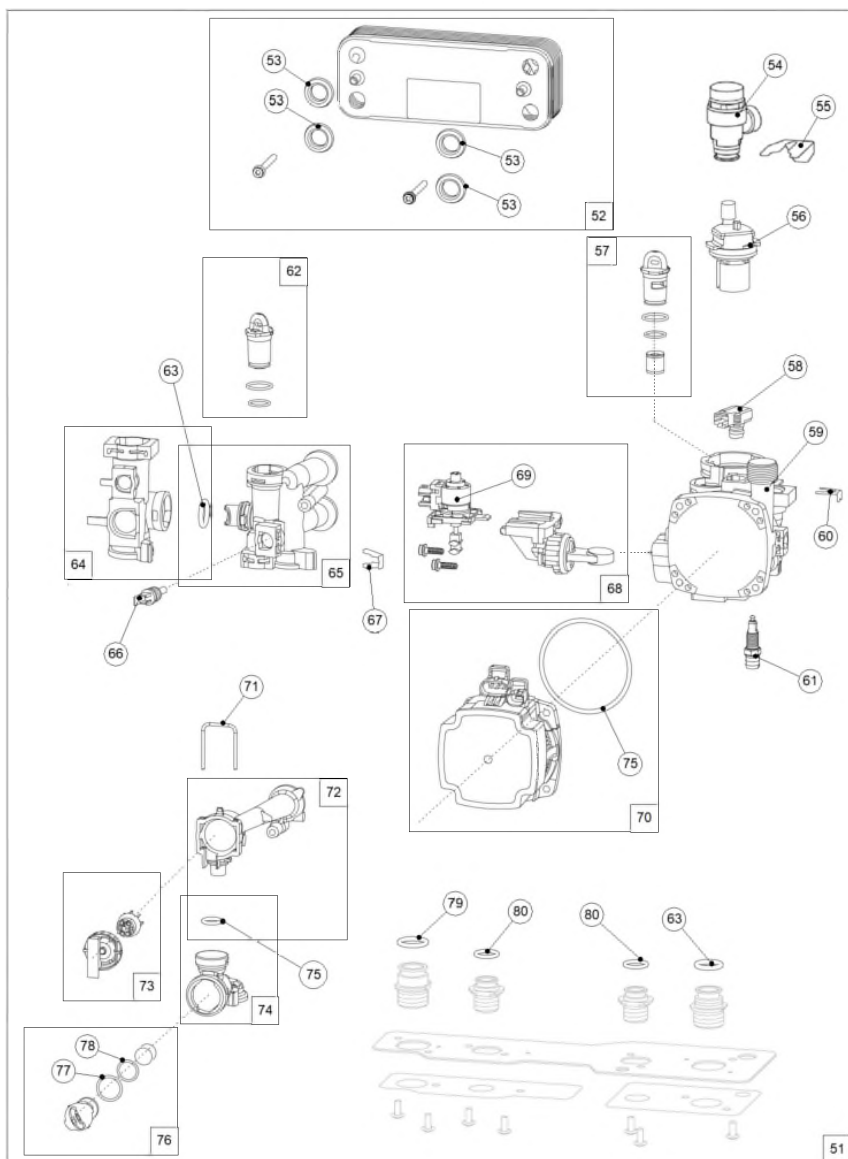



Burner + heat exchanger

	Code	Code GA	Quant.	Photo	Description	De --- A ---	Remarque
202	A1007124	780269	1		Adaptateur + orifice -Ø (60/100) - Ø (80/125) + Collier de serrage	15-02-22-	780269
203	A1007125	780270	1		Twin Box PP + orifice Adapter -Ø (80/80) +Collier de serrage	15-02-22-	780270

Hydrobloc



Hydrobloc

Code	Quant.	Photo	Description	De --- A ---	Remarque
51 943153	1		Hydrobloc 18/25	15-02-22-	18/25-> 18/25 BE-
51 943154	1		Hydrobloc 22/30	15-02-22-	22/30-> -22/30 BE
52 161152	1		Échangeur à plaques	15-02-22-	12-> -22/30 BE
52 161153	1		Échangeur à plaques	15-02-22-	14-> 18/25 BE-
53 142459	4		Joint échangeur à plaques	15-02-22-	-> 18/25 BE- 22/30 BE
54 174434	1		Soupape	15-02-22-	3 Bar-> 18/25 BE- 22/30 BE
55 110123	1		Agrafe D18	15-02-22-	D18-> 18/25 BE- 22/30 BE
56 159441	1		Purgeur	15-02-22-	-> 18/25 BE- 22/30 BE
57 110131	1		Clapet bipasse 300 Noir	15-02-22-	300 noir-> 18/25 BE- 22/30 BE
58 159813	1		Capteur de pression	15-02-22-	-> 18/25 BE- 22/30 BE
59 135017	1		Bloc retour	15-02-22-	-> 18/25 BE- 22/30 BE
60 110126	1		Agrafe D9	15-02-22-	D9 lg-> 18/25 BE- 22/30 BE
61 190046	1		Vis de vidange	15-02-22-	-> 18/25 BE- 22/30 BE
62 104719	1		Bouchon Solo-Combi	15-02-22-	-> 18/25 BE- 22/30 BE
63 142789	1		Joint torique 17x4 Ilea	15-02-22-	17x4-> 18/25 BE- 22/30 BE
64 135002	1		Groupe départ	15-02-22-	-> 18/25 BE- 22/30 BE
65 135032	1		Groupe départ ECS	15-02-22-	-> 18/25 BE- 22/30 BE
66 198796	1		Sonde	15-02-22-	NTC-> 18/25 BE- 22/30 BE
67 110124	1		Agrafe D9	15-02-22-	D9-> 18/25 BE- 22/30 BE
68 150313	1		Vanne 3 voies + clapet	15-02-22-	-> 18/25 BE- 22/30 BE

Hydrobloc

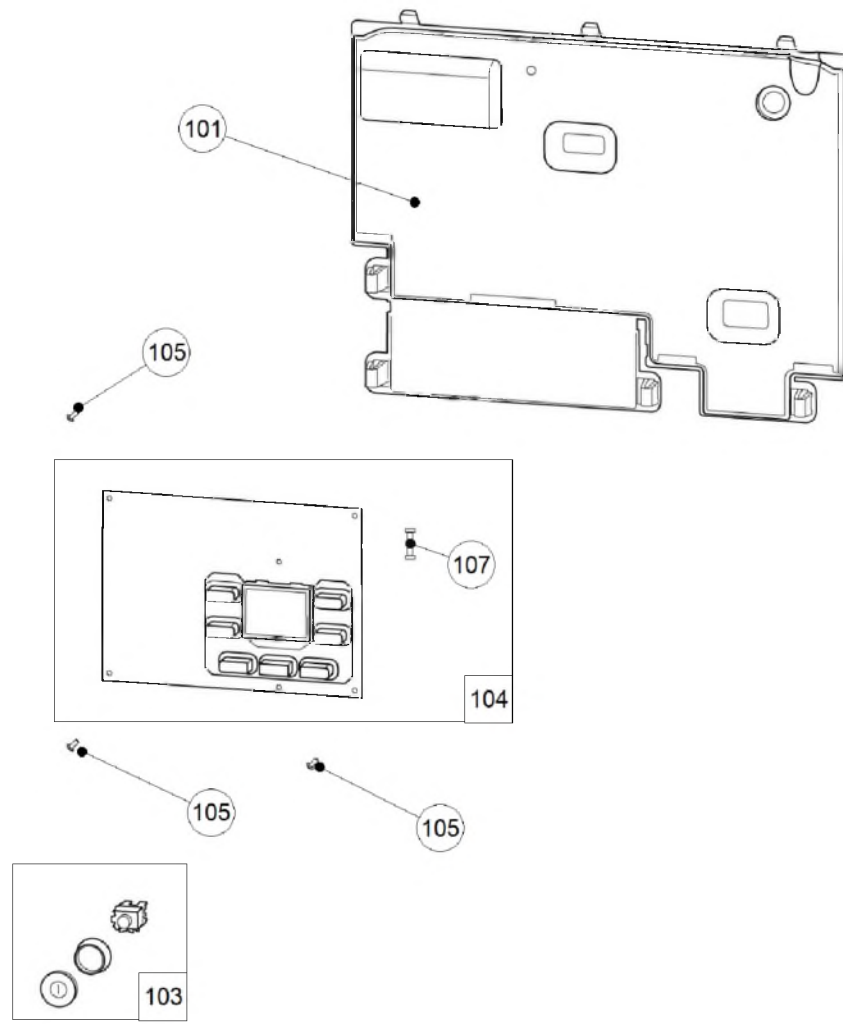
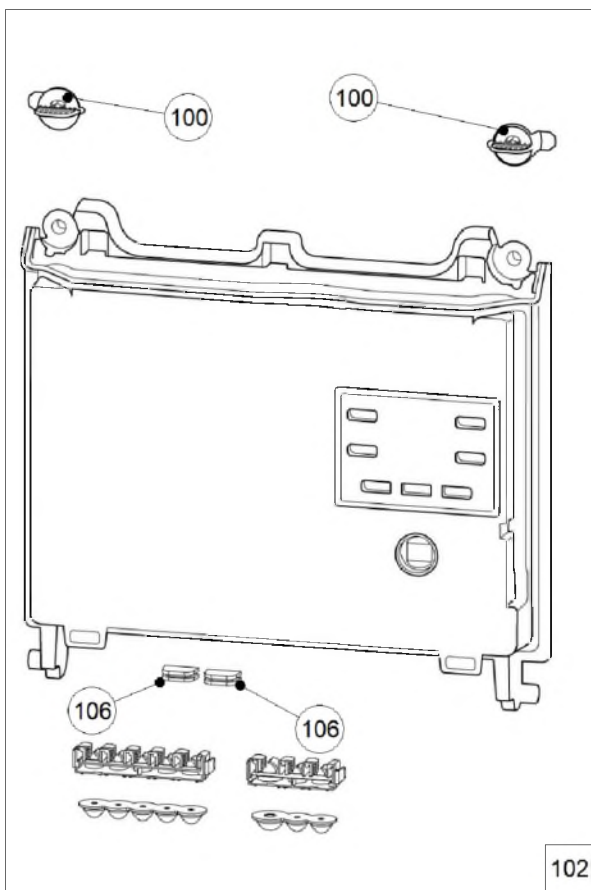

Code	Quant.	Photo	Description	De --- A ---	Remarque
69 150331	1		Moteur vanne 3 voies	15-02-22-	- > 18/25 BE- 22/30 BE
70 109984	1		Circulateur avec joint 6m	15-02-22-	7m-> - 22/30 BE
70 109986	1		Circulateur avec joint 7m	15-02-22-	6m-> 18/25 BE-
71 100196	1		Agrafe	15-02-22-	- > 18/25 BE- 22/30 BE
72 119445	1		Logement débitmètre	15-02-22-	- > 18/25 BE- 22/30 BE
73 149980	1		Débitmètre	15-02-22-	- > 18/25 BE- 22/30 BE
74 135030	1		Groupe arrivée EFS	15-02-22-	- > 18/25 BE- 22/30 BE
75 142792	1		Joint torique 12x3 Ilea	15-02-22-	12x3-> 18/25 BE- 22/30 BE
76 146321	1		Limiteur de débit sanitaire Red	15-02-22-	Rouge, corps bleu-> 18/25 BE-
76 146323	1		Limiteur de débit sanitaire Pink	15-02-22-	Rose, corps bleu-> - 22/30 BE
77 142794	1		Joint torique 19x2 Ilea	15-02-22-	19x2-> 18/25 BE- 22/30 BE
78 142793	1		Joint torique 15,6x1,78 Ilea	15-02-22-	15,6x1,78-> 18/25 BE- 22/30 BE
79 142790	2		Joint torique 9,8x3,6 Ilea	15-02-22-	19,8x3,6-> 18/25 BE- 22/30 BE
80 142791	2		Joint torique 16x3 Ilea	15-02-22-	16x3-> 18/25 BE- 22/30 BE

Electrical box





Electrical box

Code	Code GA	Quant.	Photo	Description	De --- A ---	Remarque
100	139228	1		Bouton 1/4 de tour	15-02-22-	
101	110412	1		Coffret Arrière V2	15-02-22-	
102	977100	1		Coffret avant	15-02-22-	ILEA
103	943021	1		Interrupteur M/A	15-02-22-	
104	965435	1		CONTROLLER ILEA 18/25 BE	15-02-22-	ILEA 18/25 BE
104	965436	1		CARTE DE REGULATION/SECU/HMI ILEA 22/30	15-02-22-	ILEA 22/30 BE
105	190064	3		Vis carte de régulation	15-02-22-	
106	104743	1		Bouchon coffret électrique	15-02-22-	
107	199925	1		Fusible 15	15-02-22-	F3.15AL250VP ou T3.15AH250V

Wiring

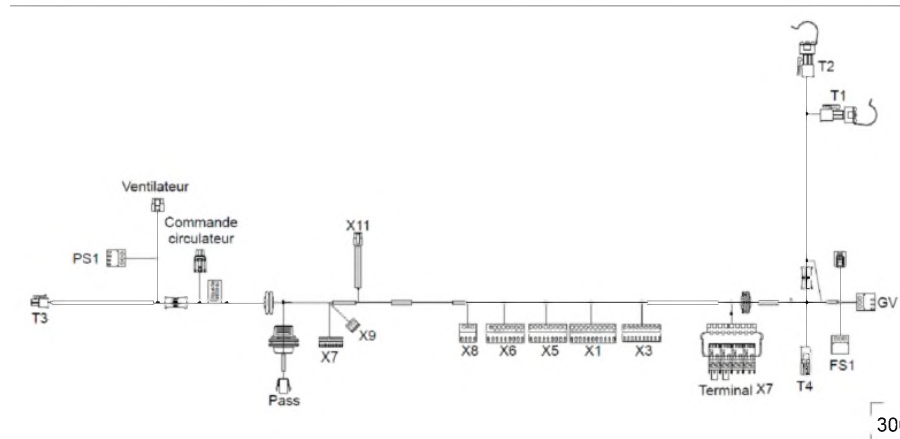

300

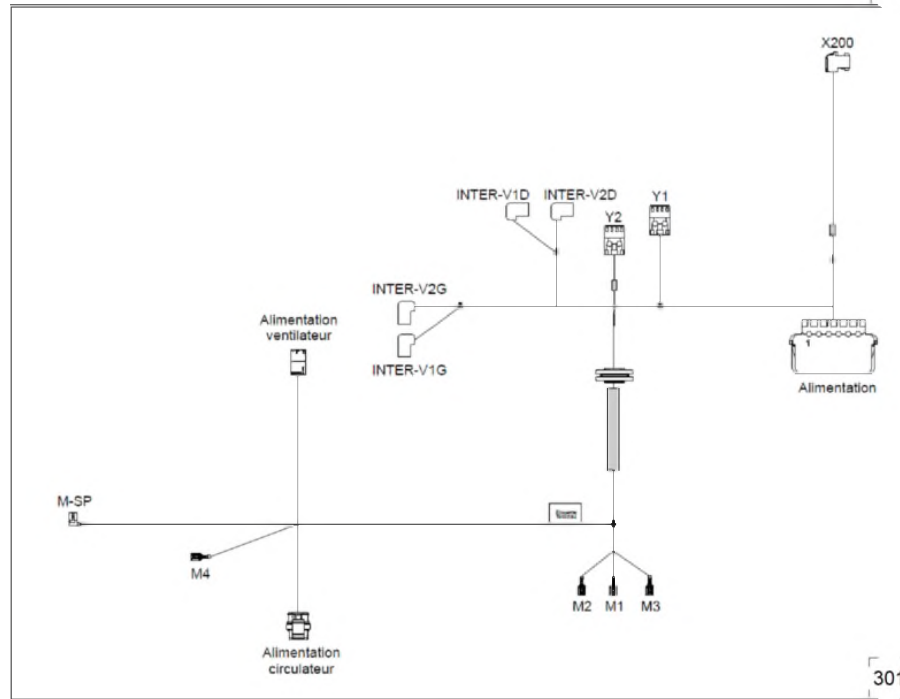

301



Wiring

	Code	Quant.	Photo	Description	De --- A ---
300	109367	1		Faisceau 24V BE	15-02-22-
301	109373	1		Faisceau 230V	15-02-22-

Hydro connection kit (bottom connection)

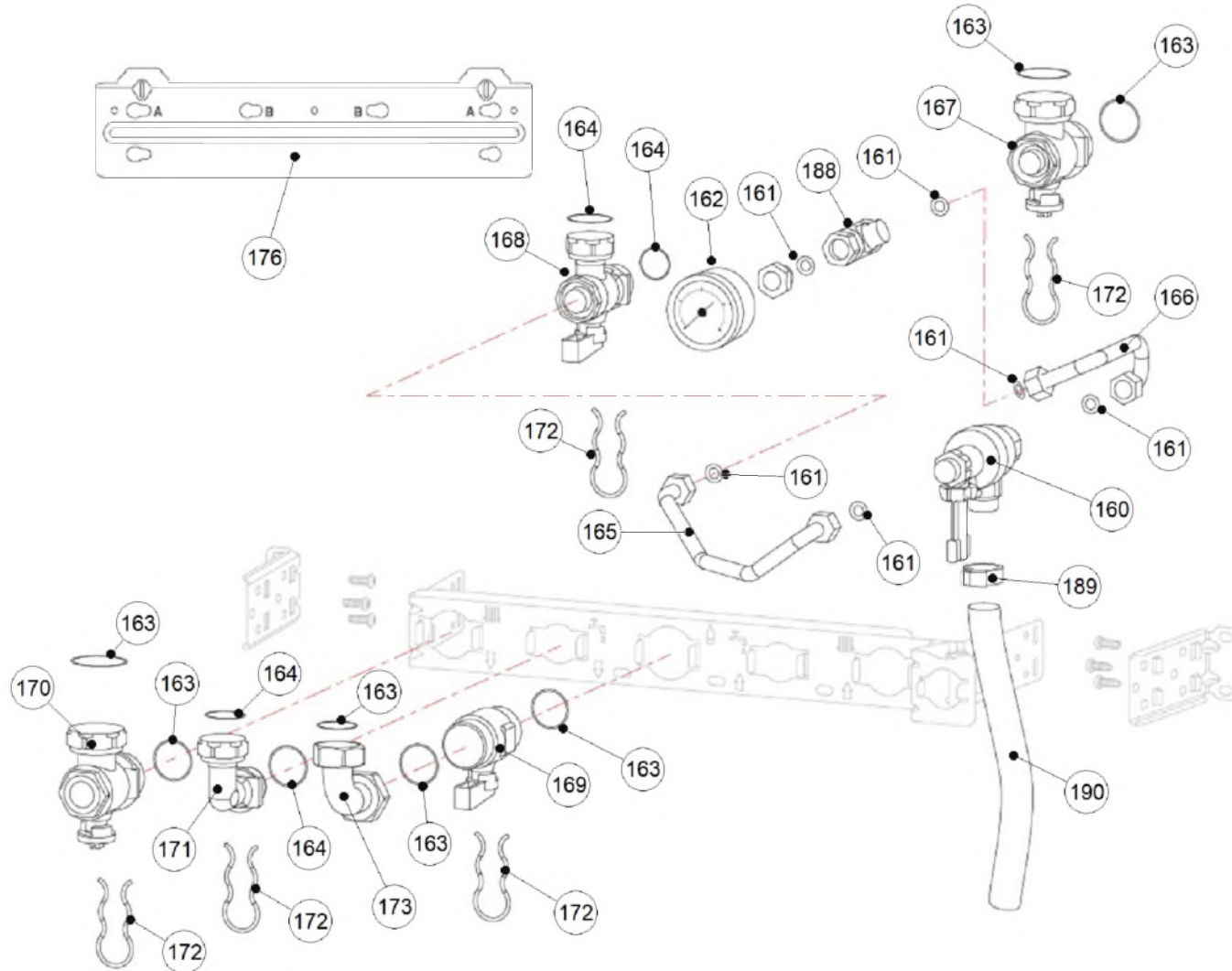



Hydro connection kit (bottom connection)

Code	Code GA	Quant.	Description	De --- A ---	Remarque
160	119528	1	Disconnecteur / Afsluiter / Trenner	15-02-22-	
161	142912	6	Joint / Dichting / Dichtung	16-02-22-	
162	149948	1	Manomètre / Manometer / Manometer	17-02-22-	
163	142442	7	Joint / Dichting / Dichtung	18-02-22-	
164	142723	4	Joint - Dichting - Dichtung	19-02-22-	
165	182446	1	Tube entrée disconnecteur - Ingangsbuis afsluiter - Einlassrohr Trenner	20-02-22-	
166	182541	1	Tube sortie disconnecteur / Uitlaatbuis afsluiter / Auslassrohr Trenner	21-02-22-	
167	188900	1	Vanne retour installation / Terugslagklep installatie / Rücklaufventil Anlage	22-02-22-	
168	188901	1	Vanne arrivée EFS - Invoerklep SKW - Trinkkaltwassereinlassventil	23-02-22-	
169	188279	1	Robinet gaz ARGB / Gaskraan ARGB / Gasventil ARGB	24-02-22-	
170	188903	1	Vanne départ installation / Aanvoerklep installatie / Vorlaufventil Anlage	25-02-22-	
171	164328	1	Raccord laiton ECS - Messing aansluiting SKW - TWW- Messinganschluss	26-02-22-	
172	134607	5	Goupille / Pin / Arretierstift	27-02-22-	
176	174511	1	Support mural / Wandbeugel / Wandkonsole	28-02-22-	
188	177546	1	Té / T / T-Stück	01-03-22-	"1/4" " "
189	134608	1	Bague de serrage / Sluitering / Spannring	02-03-22-	
190	182730	1	Tube évacuation / Evacuatiebuis / Abzugsrohr	03-03-22-	