

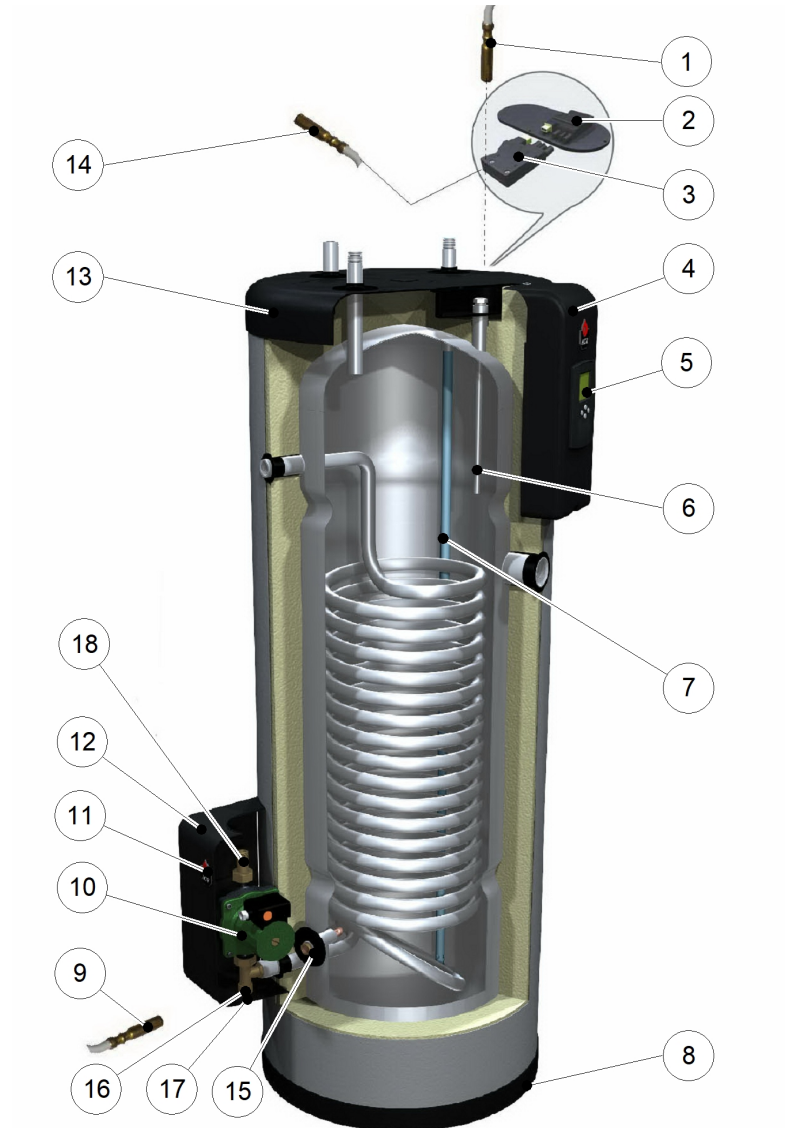















## Drainback 200





## Drainback 200

	Code	Code GA	Quant.	Photo	Description	De --- A ---	Remarque
1	5476G051	786521	1		Sonde tempér. PT1000 câble en PVC L:1000	01-01-10-	DHW sensor
2	54762058		1		Connect.F 2P 50V 3A & 3P 250V 16A	01-01-10-31-12-11	
2	54762061	788127	1		Prise F 5 poles P-N-PE 230V	01-01-12-	
3	54762059		1		Connect.M 2P 50V 3A & 3P 250V 16A	01-01-10-31-12-11	
3	54762060	785189	1		Prise M 5 poles P-N-PE 230V	01-01-12-	
4	497B3000	785886	1		Cache boitier de commande DrainBack	01-01-10-	
5	5476v027	786546	1		Controlleur DrainBack Solareg II SR-R400	01-01-10-	
6	39438023	784820	1		Doigt de gant inox 1/2x350	01-01-10-	
7	497B0009	788146	1		Plonge PVCC 19,5x1340 perç.lat.	01-01-10-	
8	A1003197	787146	1		Calotte inférieure Smart 100 -> 240 V08	01-11-16-	PREV 497B5015
9	5476g053	786523	1		Sonde PT1000 câble en PVC L:2000	01-01-10-	
10	A1003899	787276	1		Pompe Yonos STG 15/1-13 L180	01-01-10-	
11	617G1004	786790	1		Logo ACV	01-01-10-	
12	497b3001	785887	1		Cache pour circulateur DrainBack	01-01-10-	
13	497B5010	785900	1		Calotte supérieure Smart STD 100-240	01-01-10-	
14	5476g050	786520	1		Sonde PT1000 câble silicone L:1000	01-01-10-	Solar collector sensor
15	39438067	784831	1		Doigt de gant inox 1/2x100	01-04-13-	Prev: 63960004
16	4372F000		1		Té DrainBack M3/4'-F4/4'-F1/2'	01-01-12-	
17	55426001	785274	1		Robinet de vidange 1/2	01-01-12-	
18	557A6009	786721	1		débitmètre 3/4" M	01-01-12-	



Drainback 200

Code	Code GA	Quant.	Photo	Description	De --- A ---	Remarque
99	54764032	785220	0 	T-stat 0-85°C+110°C safety 3ph.	01-11-12-	for 10800081-4 heating elements