

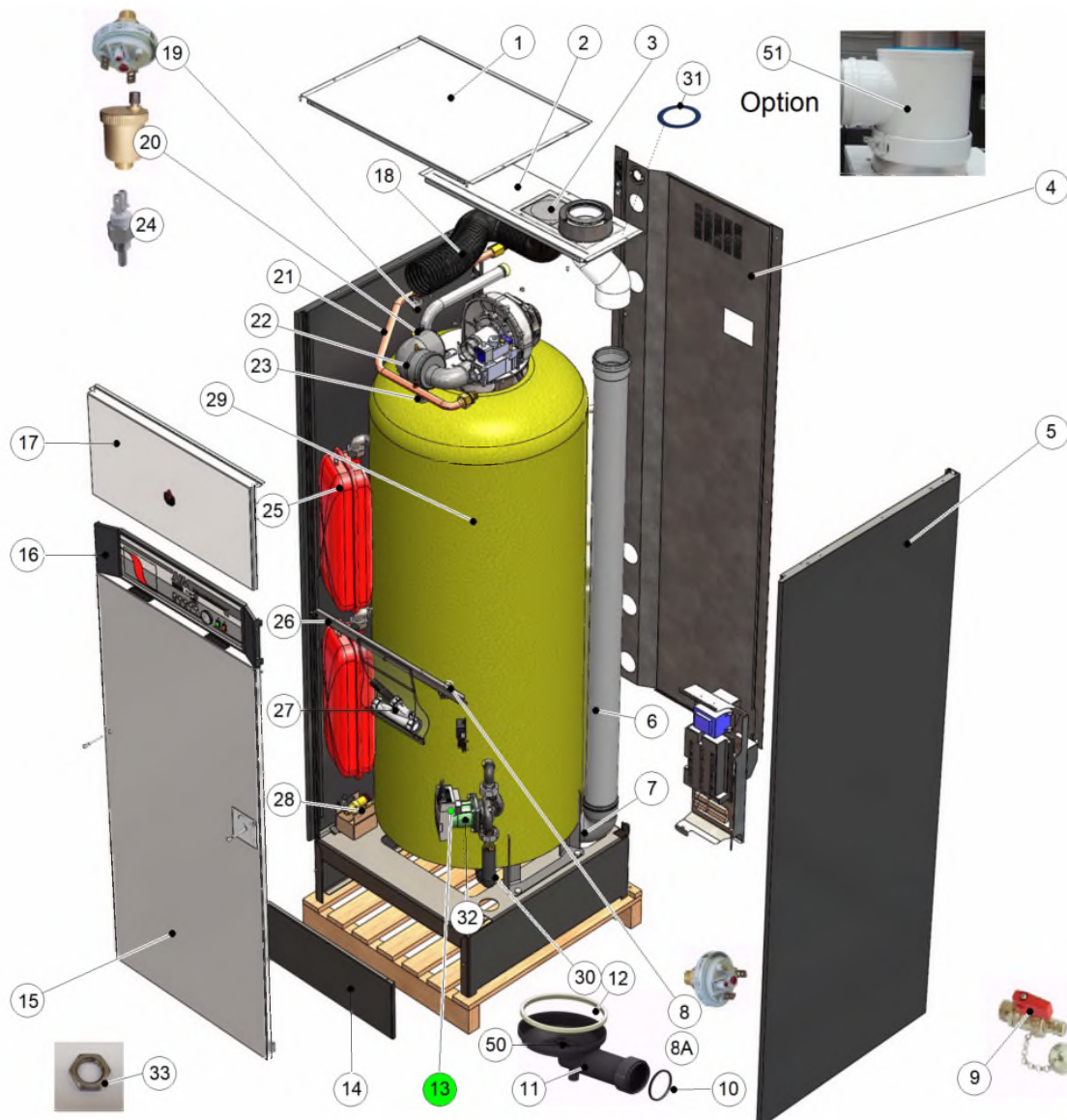







Panels+acc. HM120TC















Panels+acc. HM120TC

Code	Code GA	Quant.	Picture	Description	From --- To ----	Remark
1	21479487	1		Panel upper front HM70-85-120TC	15-05-13-	
2	21475487	784636	1	Top panel rear HM70-85-120TC	15-05-13-	
3	507F3047	785944	1	Adapter 100+100->100-150 HM70-120TC	15-05-13-	
4	20474487		1	Rear panel HM70-85-120TC	15-05-13-	
5	21471487		2	Side panel LH&RH HM70-85-120TC	15-05-13-	
6	537D6258	786243	1	Flue pipe D100x1650 HM70-85-120TC	15-05-13-	
7	537D6438	786295	1	Elbow 90° MF DN100 PP grey +lip seal	15-05-13-	
8	557A1056	786672	1	 -OBS- Low pressure switch 1/4 0,5-0,8 bar	15-05-13-31-12-15	Prev : 557A1056
8A	A1002747	787022	1	 Low press.switch 1/4 CEME	01-01-16-	
9	55426001	785274	1	 Drain cock 1/2	15-05-13-	
10	557A0106	786601	2	 Lip gasket DN100 HR-EPDM black	15-05-13-	
11	10800262	784433	1	 Condens.coélect.HMTC large +gaskets	15-05-13-	
12	557A0145	786621	1	 Gasket ID:250 condens.coélect.HM85TC	15-05-13-	
13	257F1143	785791	1	 Pump HEP wired HM70->120TC V13 (ERP)	15-05-13-	ERP
14	21476487	784659	1	Front panel base HM120TC	15-05-13-	
15	21473486		1	Front panel lower HM70-85-120TC (V13)	15-05-13-	
16	21477486		1	Control panelHM70-85-120TC (V13)	15-05-13-	
17	21478426	784678	1	Front panel upper HM70-85-120TC	15-05-13-	
18	537D6468	786320	1	Flexible hose D:100 L:400mm	15-05-13-	
19	537DC000	786426	1	 Gas pressure switch Prest.-HMTC	15-05-13-	



Panels+acc. HM120TC





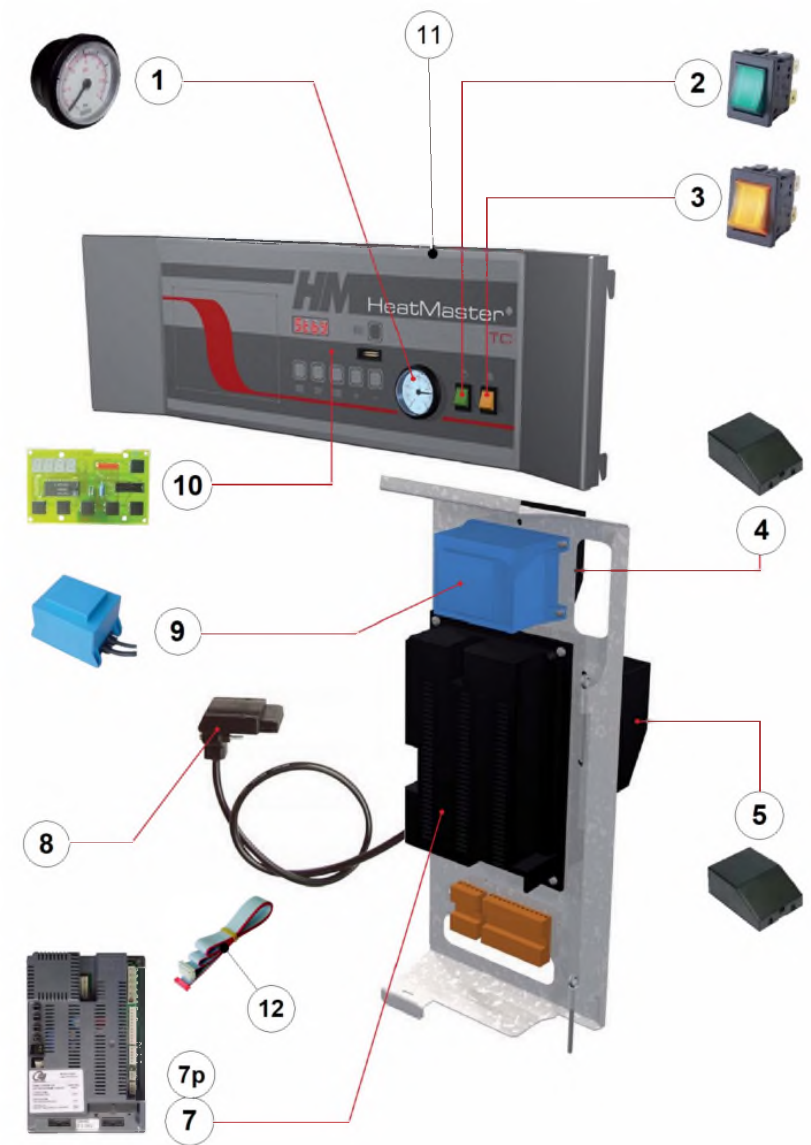



Code	Code GA	Quant.	Picture	Description	From --- To ----	Remark
20	557A3001	786695	1	 Air vent auto.1/2 brass	15-05-13-	
21	507F4270	786016	1	Gas pipe HM120TC	15-05-13-	
22	497B0055	785867	1	Silencer HM120TC	15-05-13-	
23	39438046	784824	1	 Dry well SST 1/2x950	15-05-13-	
23	5476G003	786491	1	 NTC sensor 12k L:3200mm for tank	15-05-13-	
24	5476G008	786492	1	 NTC sensor 12K d5x18 1/8 +faston	15-05-13-	
25	557A7006	786723	2	 Exp.vessel 10L CH	15-05-13-	
26	2047A486	785705	1	Bracket for control panel HM70-85-120TC	15-05-13-	
27	A1003131	787100	1	 Siphon WH90 w/ball+ring+seal	01-10-16-	PREV 557A8005
28	557A1077	786683	1	 Safety valve assy 3bar 164 kW	15-05-13-	
29	30540599	784808	1	Body foamed HM120TC	15-05-13-	
30	507F4269	786015	1	Recirculation pipe HM70-85-120TC	01-09-13-	
31	557A0101	786598	2	 Gasket Dn100 (flue pipe) blue	15-05-13-	
32	A1002039	786808	1	Insulation shell pump UPML	01-11-15-	
33	4779A011	785844	1	 Nut 3/4' DIN431A SST HMTC	15-05-13-	
50	557A0144	786620	1	 Gasket 28-45x5 Viton cond.coélect.HMTC	15-05-13-	
51	537D6207	786213	1	 Chimney adapter 100-150->100+100 PP/Alu	01-09-13-	OPTION

Control panel HM120TC





Control panel HM120TC





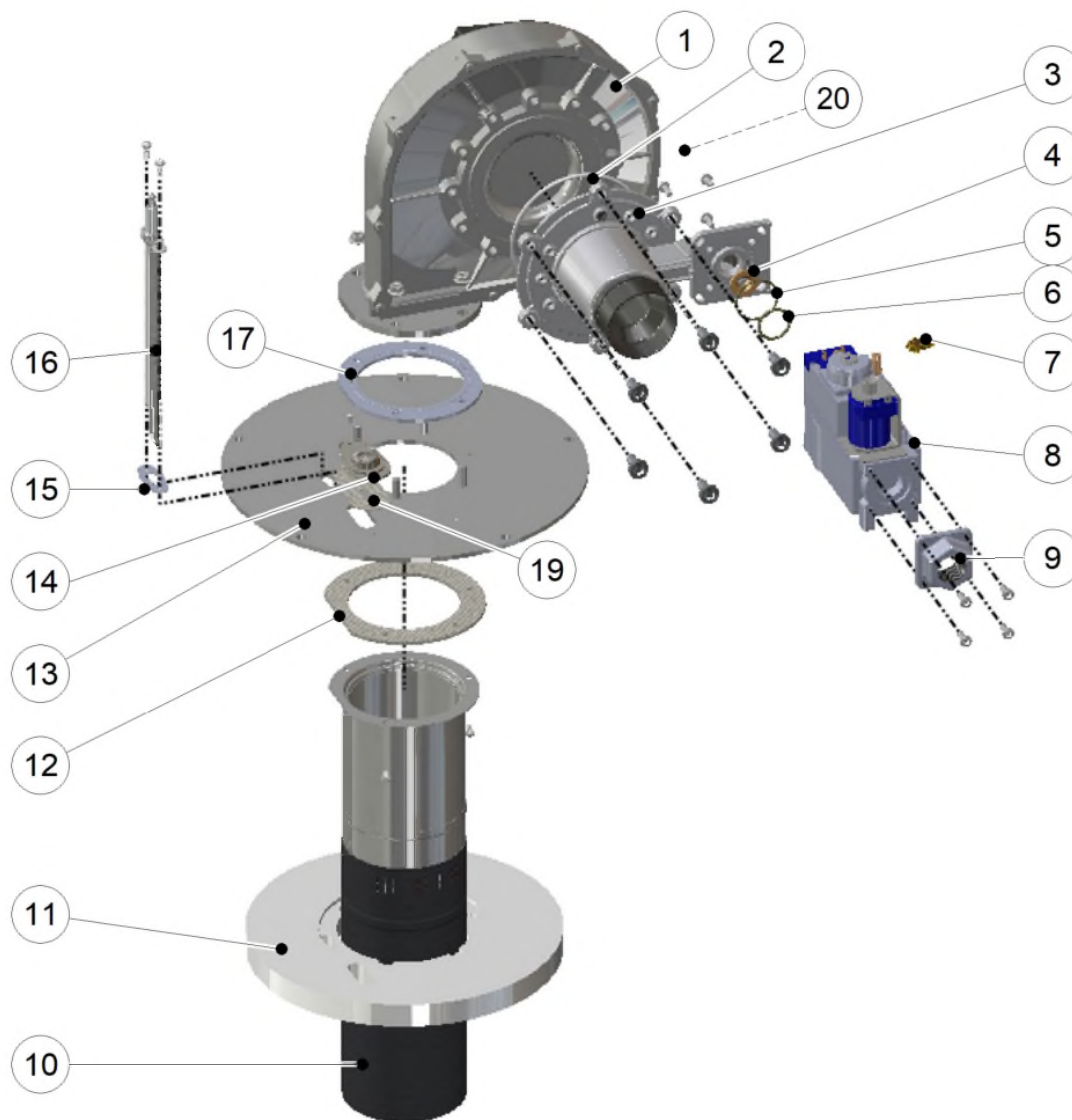











Code	Code GA	Quant.	Picture	Description	From --- To ----	Remark
1	54763017	785201	1	 Manometer 0-4 bar & 60psi D:37 black	15-05-13-	
2	54766016	785234	1	 Switch 2P green	15-05-13-	
3	54766017	785235	1	 Switch 2P yellow	15-05-13-	
4	10800094	784374	1	 Kit alarm module AM3-2	15-05-13-	
5	10800095	784375	1	 Kit second heating circuit AM3-11	15-05-13-	
7	5476G066	786532	1	MCBA preset for HM120TC G20-25	15-05-13-	Nat.gas
7p	5476G067	786533	1	MCBA preset for HM120TC G31	15-05-13-	Propane
8	537D3039	786102	1	 Cable L:1260 with rectifier 24V	15-05-13-	
9	547D3021	786562	1	 Transfo.230/24V 72VA+ cable 35cm MCBA	15-05-13-	
10	537D3020	786091	1	 Display for MCBA	15-05-13-	
11	24614198	784718	1	Contr.pan.cpl HM120TC	15-05-13-	
12	257F1079	785764	1	 Ribbon cable display to MCBA	15-05-13-	

Burner HM120TC





Burner HM120TC

Code	Code GA	Quant.	Picture	Description	From --- To ----	Remark
1	537D3045	786106	1	 Fan RG175-2000-3633-010205 P120 MK2	15-05-13-	
2	557A0045	786579	1	 O-ring 110x3,5	15-05-13-	
3	537D4047	786137	1	 Venturi VMS	15-05-13-	
4	537D4050	786139	1	 Orifice 10,7mm (VMS P120)	15-05-13-	Natural Gas
4	537D4054	786143	1	 Orifice 6,7mm (VMS P120)	15-05-13-	Propane
5	557a0092	786594	1	 O-ring 33x2 gas valve P120-399	15-05-13-	
6	557A0103	786599	1	 O-ring 23,47x2,62 (orifice P120)	15-05-13-	
7	53437039	785089	1	 Pressure socket D:8,5 M5	15-05-13-	
8	537D4046	786136	1	 Gas valve VR8615VB1010U	15-05-13-	
9	537D4048		1	Flange straight 3/4 for gas valve P.120	15-05-13-	
10	537DZ019	786448	1	 Burner head NIT 98x372	15-05-13-	
11	A1005074	787431	1	 Insul.burner HM BO TC V15	16-08-18-	Prev: A1002431 - 51700126 - 557A0176
12	A1002432	786973	1	 Gasket burnerhead HMTC BO V15	15-05-13-	prev 557a0154
13	507F4268		1	Burner plate HM120TC	15-05-13-	
14	507F4283	786028	1	 Sight glass kit (monobloc)	01-08-13-	Prev: 507F4164
15	557A0163	786635	1	 Gasket électrode dual ceramic	15-05-13-	
16	10800313	784486	1	 Kit électrode for HMTC large +screws+gask.	01-09-13-	incl screws & gasket
17	557A0085	786590	1	 Gasket for fan RG175 (100-120kW)	15-05-13-	
19	557A0149	786623	1	 Gasket sight glass monobl (68x32x2 GPE)		
20	54760069		1	Cable extension fan HM120TC	01-04-15-	