

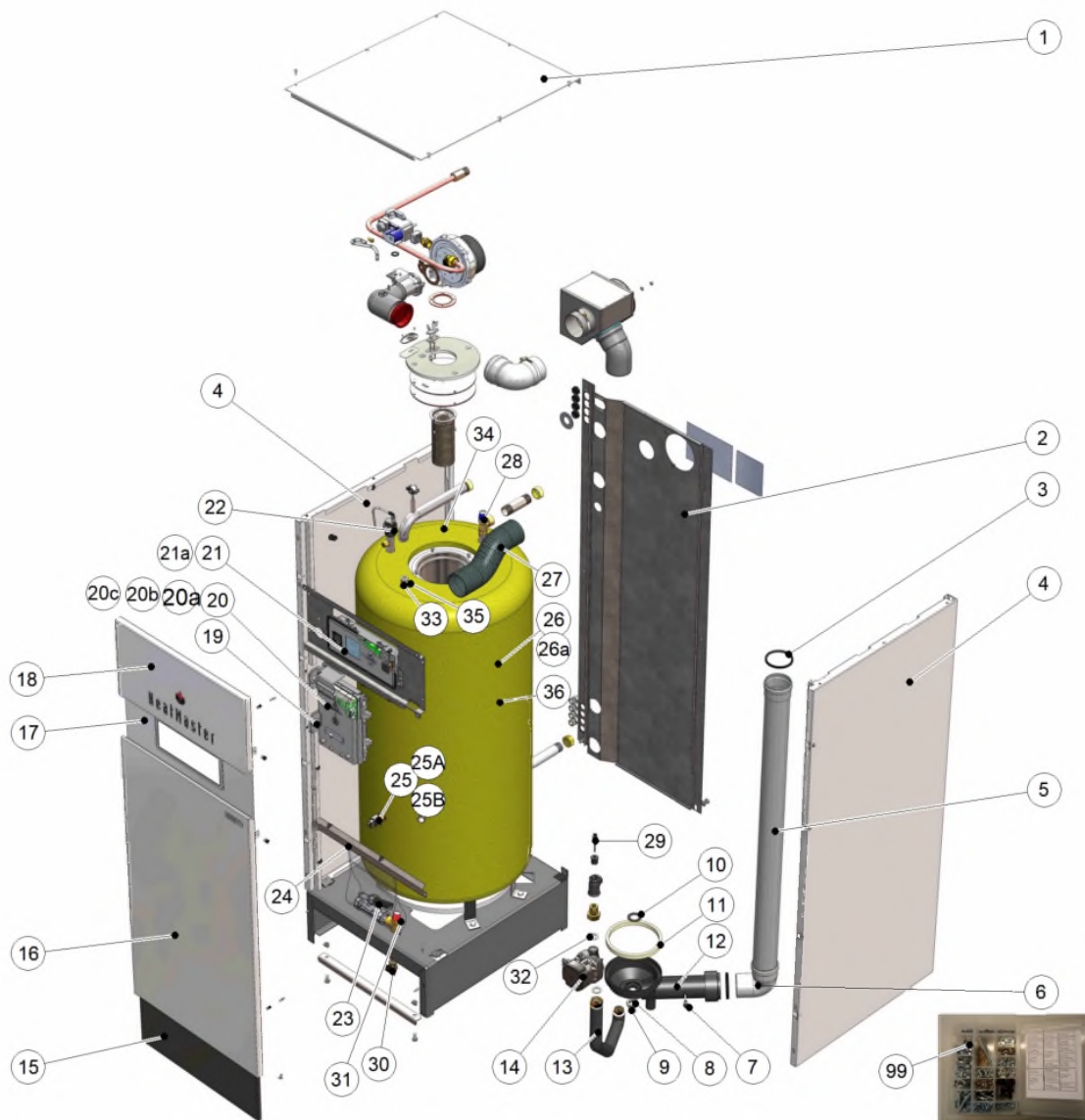

HeatMaster 25-35-45TC V15

















HeatMaster 25-35-45TC V15

Code	Code GA	Quant.	Photo	Description	De --- A ---	Remarque
99	10800265	784436	1	 Kit visserie chd.condens.	01-01-16-	
1	21475514	784647	1		01-01-16-	
2	28474514	784766	1		01-01-16-	
3	557A0105	786600	2	 Joint à lèvres DN80 HR-EPDM noir	01-01-16-	
4	28471514	784751	2		01-01-16-	
5	537D6237	786233	1		01-01-16-	
6	537D6403	786285	1	 Coude 90° MF DN80 PP gris+joint	01-01-16-	
7	5476g054	786524	1	 Sonde NTC 12K d5x50 1/8' +conn. Molex	01-01-16-	
8	4779A011	785844	1	 Ecrou 3/4 DIN431A inox HMTc	01-01-16-	
9	557A0147	786622	1	 Joint 24x14x2 novapress basic	01-01-16-	
10	A1004464	787332	1		01-01-16-	
11	557A0141	786618	1	 Joint DI:166 bac.condens.HM35TC	01-01-16-	
12	10800261	784432	1	 Bac condens.PPS+joints HM35TC-25 C	01-01-16-	
13	507F4346	786058	1	 Tube de recirculation HMTc petit V15	01-01-16-	
14	A1003579	787219	1	 -OBS- Circul. UPM3 15-75 L130 G1 fonte	01-11-16-	- Obsolete - PREV 557A4036
15	28478514	784775	1		01-01-16-	
16	28473514	784762	1		01-01-16-	
17	025008		1		01-01-16-	Prev : 21477514
18	28476514	784773	1		01-01-16-	
19	5476V056	786553	1	 Charnière boîtier élec. Prest.V14	01-01-16-	





HeatMaster 25-35-45TC V15

Code	Code GA	Quant.	Photo	Description	De --- A ---	Remarque
20c	257F1169	1		Câblage 230V HMTC small V15		
20b	A1002111	1		Câblage 24V HMTC small V15		
20a	A1003599	787222	1	 Circ.impr.ACVMAX 230V (E) S4962S3038B		PREV A1002115
20	A1003626	787234	1	Tableau complet HM small TC V15 Vers. 2	01-10-16-	PREV A1002935
21a	A1002098	786834	1	 Circ.impr.display DSP49G2243 ver.C 256k		
21	A1003098	787082	1	 Boîtier display cpl HM Prestige Ver. D	01-06-16-	
22	557A3007	786699	1	 Purgeur air auto.composite P32 V14	01-01-16-	
23	A1003132	787101	1	 Siphon DH50+bille+bague+joint	01-10-16-	PREV 557A8004
24	2047A514	785706	1	Raidisseur lat.HMTC petit V15	01-01-16-	
25B	507F4288	786033	1	Raccord capteur pression P100-120 V14	01-01-16-	
25A	507F4289	786034	1	 Epingle capteur sonde Prest.V14	01-01-16-	
25	557A6010	786722	1	 Capteur de pression Prest.V14	01-01-16-	
26	30540660	784814	1	Corps moussé HMTC petit volume V15	01-01-16-01-05-18	Rigid PU insulation
26a	A1005132		1	Corps+isol.souple HMTC Petit Vol. V15	01-05-18-	soft insulation
27	537D6513	786360	1	 Flexible Masterflex D80 L350	01-01-16-	
28	A1002104	786837	1	 Soupape secur.8bar 3/4 sanit	01-01-16-	
29	5476g054	786524	1	 Sonde NTC 12K d5x50 1/8' +conn. Molex	01-01-16-	
30	55426001	785274	1	 Robinet de vidange 1/2	01-01-16-	
31	557A1089	786689	1	 Soupape sécur.3bar 82kW 1/2->1/2	01-01-16-	
32	557A0050	786580	2	 Joint 30x20x2 fibre	01-01-16-	



HeatMaster 25-35-45TC V15

Code	Code GA	Quant.	Photo	Description	De --- A ---	Remarque
33	39438027	784821	1	 Doigt de gant inox 1/2x500	01-01-16-	
34	5476G047	786519	1	 Sonde NTC 12K d5x18 1/8 +Molex conn.	01-01-16-	
35	547D3018	786561	1	 Sonde NTC 12K L1500 pour ballon	01-01-16-	
36	A1005075		1	Kit Isolation HMTc SO	01-05-18-	





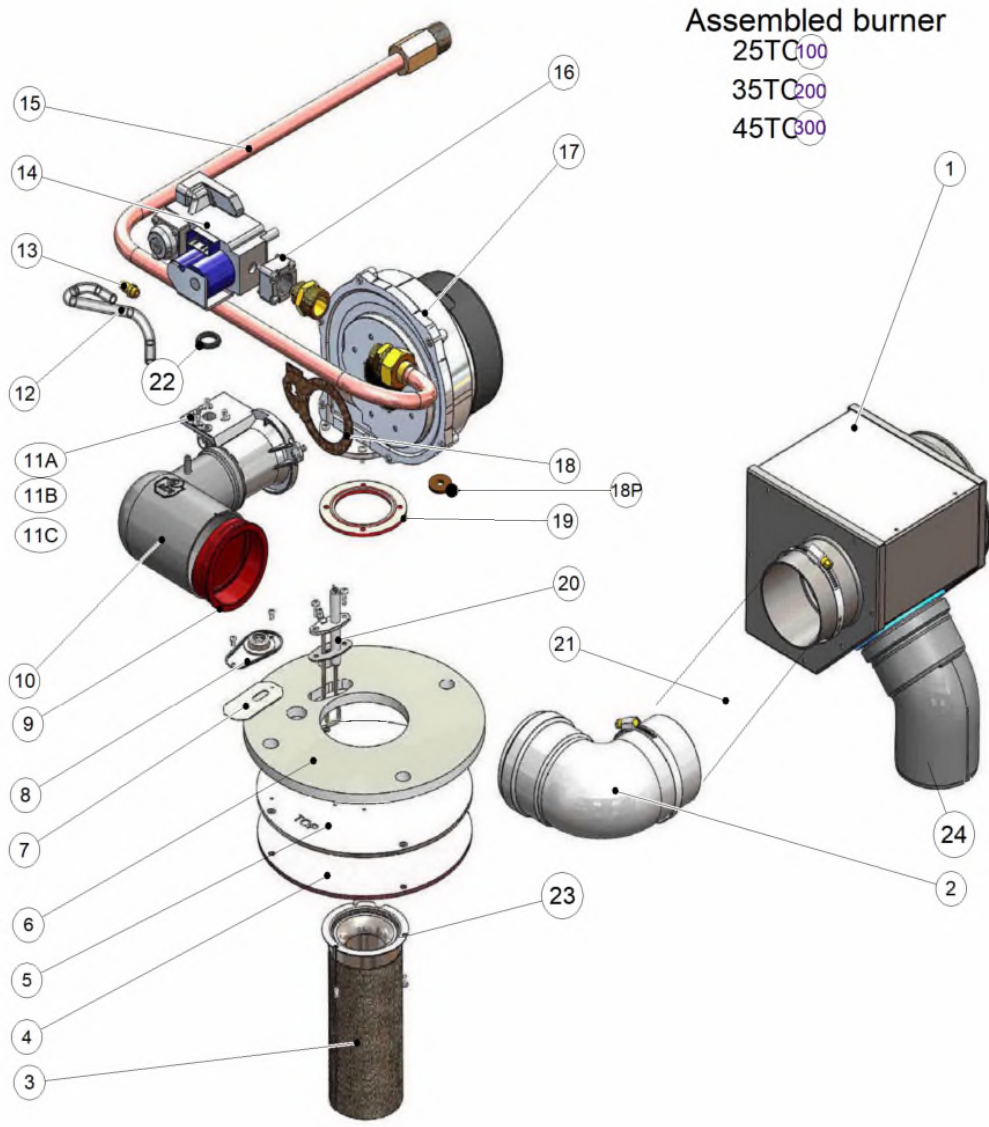













Burner HM 25-35-45TC V15













Burner HM 25-35-45TC V15

Code	Code GA	Quant.	Photo	Description	De --- A ---	Remarque
1	507F4345	786057	1	 Adapt.ventouse HMTC petit V15	01-01-16-	
2	537D6403	786285	1	 Coude 90° MF DN80 PP gris+joint	01-01-16-	
3	537DZ050	786470	1		01-01-16-	
4	A1005072	787430	1	 Isol.brûleur Pioneer HM SO TC V15	-21-08-18	2in1insulation - prev: A1002429 - 51700128&557a0179
5	507F4351	786063	1		01-01-16-	
6	51700145	785015	1	 Isol. sup. brûleur HMTC petit V15	01-01-16-	
7	557A0149	786623	1	 Joint regard flamme monobl(68x32x2 GPE)	01-01-16-	
8	507F4283	786028	1	 Kit regard flamme monobloc	01-01-16-	
9	557A9000	786728	1	 Clapet anti-retour prise d'air DN80	01-01-16-	
10	537D6511	786358	1	 Coude réduc. 80->50 HMTC V15	01-01-16-	
11B	537D4034	786131	1	 Venturi VF002	01-01-16-	HM35TC
11A	537D4067	786152	1		01-01-16-	HM25TC
11C	537D6038	786187	1	 Venturi VF001	01-01-16-	HM45TC
12	49437026	784906	1	 Flexible silicone 5x9	01-01-16-	
13	53437039	785089	1	 Prise de pression D:8,5 M5	01-01-16-	
14	537D4009	786121	1	 Vanne gaz VK4115V1014	01-01-16-	
15	507F4111	785966	1		01-01-16-	
16	53402088	785026	1	 Bride droite vanne gaz 1/2	01-01-16-	
17	537d3059	786116	1	 Ventil.RG128-1300 230V rotated 120°	01-01-16-	
18P	537D4082	786160	1	 Opercule 5,2mm 0.2047"		HM25tc-35tc propane



Burner HM 25- 35-45TC V15

Code	Code GA	Quant.	Photo	Description	De --- A ---	Remarque
18P	537D4013	786124	1	 Opercule 6mm (VF001 G31)	01-01-16-	HM45TC propane
18	557A0026	786570	1	 Joint (liège) venturi	01-01-16-	
19	557A0199	786652	1	 Joint silicone ventil. HMTC PV V15	01-01-16-	
20	A1002510	786988	1	 Kit électrode P24- 32- 100- 120 V14+vis+joint	01-01-16-	
21	537D6513	786360	1	 Flexible Masterflex D80 L350	01-01-16-	
22	557A0098	786597	1	 Joint vanne gaz-venturi	01-01-16-	
23	A1002430	786971	1	 Joint rampe brûleur HMTC PV V15	03-02-17-	prev 557a0153
24	A1002006	786803	1	 Coude 45° DN80 PP		
25	A1005072	787430	1	 Isol.brûleur Pioneer HM SO TC V15	20-08-18-	Prev : 51700145-507f4351-A1002429
100	237D0191		1		22-11-19-	HM 25 TC GN V15
200	237D0192		1		22-11-19-	HM 35 TC GN V15
300	237D0193		1		22-11-19-	HM 45 TC GN V15