

WaterMaster X EVO 25-45

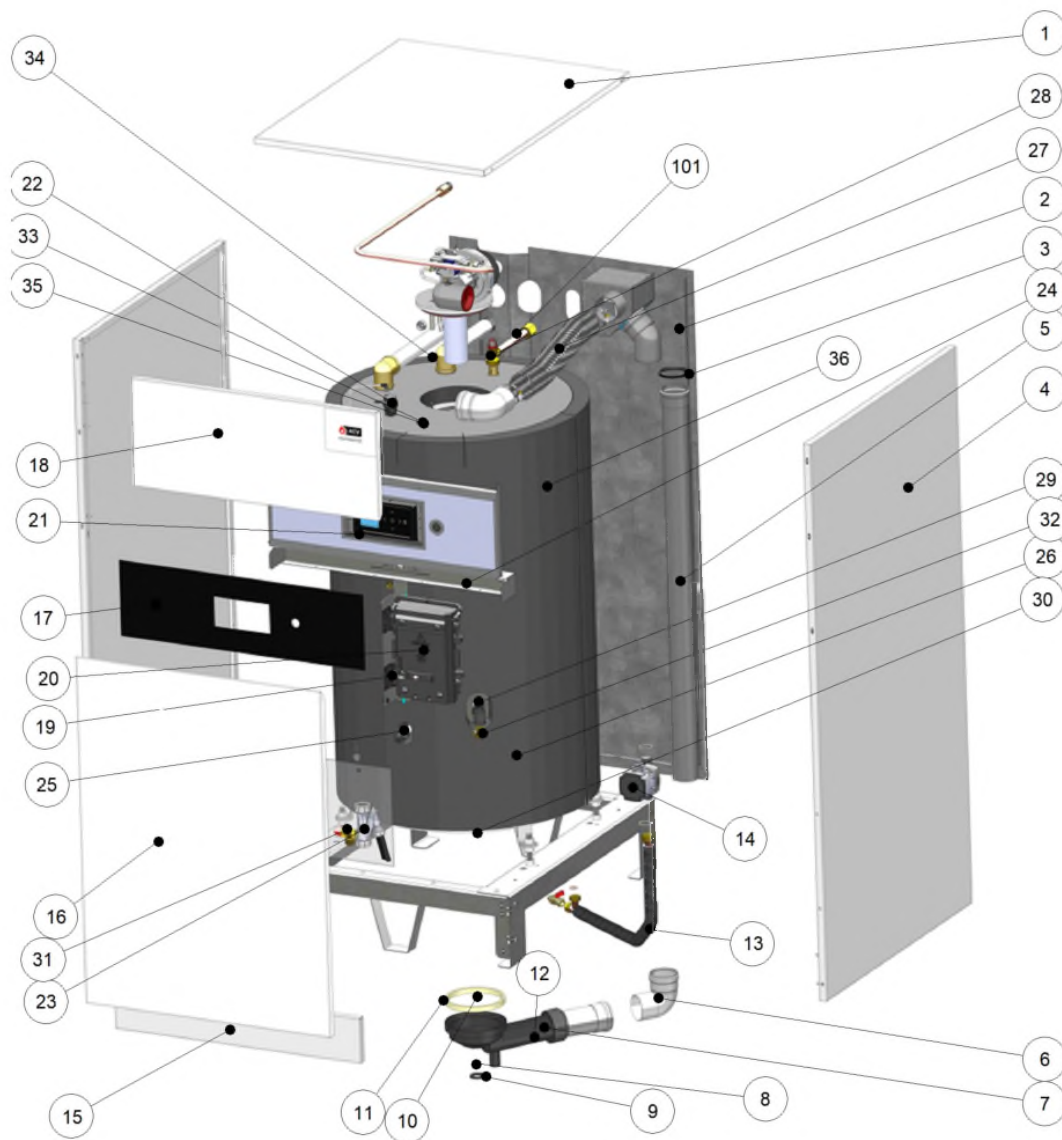













WaterMaster X EVO 25-45

	Code	Code GA	Quant.	Photo	Description	De --- A ---
	564040	564040	0		Tableau électrique HM-WM TC V21	20-01-22-
	564061	564061	0		TUBE D'ARROSAGE PVCC 39,5x650 DÉBRANCHÉ.	20-01-22-
	564095	564095	0		Rallonge conduit de fumée Ø80	20-01-22-
	564123	564123	0		Interrupteur général 2P HM-WM	20-01-22-
1	564064	564064	0		Panneau supérieur Evo_XO	20-01-22-
2	564053	564053	0		Face arrière Evo_XSO	20-01-22-
3	557A0105	786600	2		Joint à lèvres DN80 HR-EPDM noir	20-01-22-
4	564069	564069	0		Panneau latéral G/D Evo_XSO	20-01-22-
5	537D6237	786233	1		Tube fumée D80 L1220 HM25-35-45TC	20-01-22-
6	537D6403	786285	1		Coude 90° MF DN80 PP gris+joint	20-01-22-
7	5476g054	786524	1		Sonde NTC 12K d5x50 1/8' +conn. Molex	20-01-22-
8	4779A011	785844	1		Ecrou 3/4 DIN431A inox HMTC	20-01-22-
9	557A0147	786622	1		Joint 24x14x2 novapress basic	20-01-22-
10	A1004464	787332	1		Joint 28-45x4 Viton bac condens.HMTC	20-01-22-
11	557A0141	786618	1		Joint DI:166 bac.condens.HM35TC	20-01-22-
12	10800261	784432	1		Bac condens.PPS+joints HM35TC-25 C	20-01-22-
13	564138	564138	0		TUYAU DE RECIRCULATION WM X 25-45	20-01-22-
14	564137	564137	0		POMPE UPM3 15-75 L130 G1 EUX6 FONTE	20-01-22-
15	564070	564070	0		Embase face avant Evo_XO	20-01-22-
16	564071	564071	0		Face avant inférieure Evo_XSO	20-01-22-







WaterMaster X EVO 25-45

		Code	Code GA	Quant.	Photo	Description	De --- A ---
17		564072	564072	0		Assemblage du panneau d'affichage Evo_XO	20-01-22-
18		564073	564073	0		Panneau avant supérieur Evo_XO	20-01-22-
19		564124	564124	0		BOÎTIER DE COMMANDE CHARNIÈRE ACVMAX V14 - Ignifuge	20-01-22-
20		564037	564037	0		Boîtier de commande HM petit TC V21	20-01-22-
20		564080	564080	0		Câblage 230V HMTC petit V21	20-01-22-
20		564082	564082	0		Câblage 24V HMTC petit V21	20-01-22-
20		A1003599	787222	1		Circ.impr.ACVMAX 230V (E) S4962S3038B	20-01-22-
21		564089	564089	0		Présentoir TOUCH noir HM/WM TC V21	20-01-22-
22		557A3007	786699	1		Purgeur air auto.composite P32 V14	20-01-22-
23		A1003132	787101	1		Siphon DH50+bille+bague+joint	20-01-22-
24		564074	564074	0		Assemblage du raidisseur latéral Evo_XO	20-01-22-
25		507F4288	786033	1		Raccord capteur pression P100-120 V14	20-01-22-
25		507F4289	786034	1		Épingle capteur sonde Prest.V14	20-01-22-
25		557A6010	786722	1		Capteur de pression Prest.V14	20-01-22-
26		564075	564075	0		Remplacement Corps + Isolation Evo_XSO	20-01-22-
28		564143	564143	1		Soupape T&P 3/4 7Bar L 200	20-01-22-
28		A1002104	786837	0		Soupape secur.8bar 3/4 sanit	20-01-22-
29		5476g054	786524	1		Sonde NTC 12K d5x50 1/8' +conn. Molex	20-01-22-
30		55426001	785274	1		Robinet de vidange 1/2	20-01-22-
31		557A1089	786689	1		Soupape sécur.3bar 82kW 1/2- >1/2	20-01-22-



WaterMaster X EVO 25-45





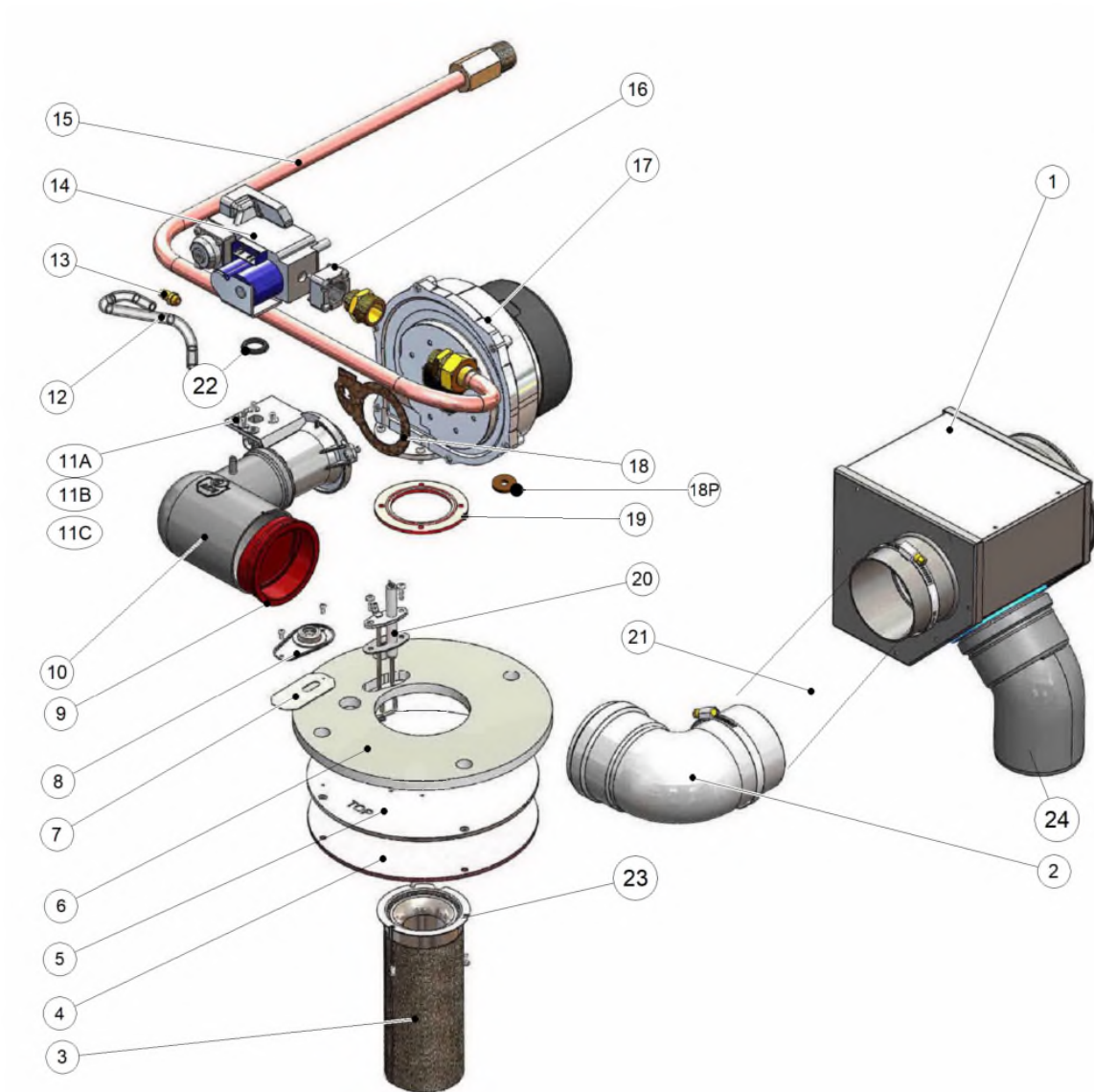











	Code	Code GA	Quant.	Photo	Description	De --- A ---
32	557A0050	786580	2		Joint 30x20x2 fibre	20-01-22-
33	39438027	784821	1		Doigt de gant inox 1/2x500	20-01-22-
34	5476G047	786519	1		Sonde NTC 12K d5x18 1/8 +Molex conn.	20-01-22-
35	547D3018	786561	1		Sonde NTC 12K L1500 pour ballon	20-01-22-
36	564131	564131	0		Kit Isolation HM TC XSO V21	20-01-22-
99	564066	564066	0		Kit de matériel de montage chaudières Evo	20-01-22-
101	564088	564088	0		Tube Cuivre T&P XO	20-01-22-

Burner WM EVO 25-45













Burner WM EVO 25-45

	Code	Code GA	Quant.	Photo	Description	De --- A ---
1	507F4345	786057	1		Adapt.ventouse HMTC petit V15	20-01-22-
2	537D6403	786285	1		Coude 90° MF DN80 PP gris+joint	20-01-22-
3	537DZ050	786470	1		Rampe NIT D70 L177	20-01-22-
4	A1005072	787430	1		Isol.brûleur Pioneer HM SO TC V15	20-01-22-
5	507F4351	786063	1		Porte brûleur HMTC petit V15	20-01-22-
6	51700145	785015	1		Isol. sup. brûleur HMTC petit V15	20-01-22-
7	557A0149	786623	1		Joint regard flamme monobl(68x32x2 GPE)	20-01-22-
8	507F4283	786028	1		Kit regard flamme monobloc	20-01-22-
9	557A9000	786728	1		Clapet anti-retour prise d'air DN80	20-01-22-
10	537D6511	786358	1		Coude réduc. 80->50 HMTC V15	20-01-22-
11	537D4034	786131	1		Venturi VF002	20-01-22-
11	537D4067	786152	1		Venturi VF003	20-01-22-
11	537D6038	786187	1		Venturi VF001	20-01-22-
12	49437026	784906	1		Flexible silicone 5x9	20-01-22-
13	53437039	785089	1		Prise de pression D:8,5 M5	20-01-22-
14	537D4009	786121	1		Vanne gaz VK4115V1014	20-01-22-
15	564098	564098	1		TUYAU DE GAZ WM X 25-45	20-01-22-
16	53402088	785026	1		Bride droite vanne gaz 1/2	20-01-22-
17	537d3059	786116	1		Ventil.RG128-1300 230V rotated 120°	20-01-22-
18	537D4013	786124	1		Opercule 6mm (VF001 G31)	20-01-22-



Burner WM EVO 25-45

		Code	Code GA	Quant.	Photo	Description	De --- A ---
18		537D4082	786160	1		Opercule 5,2mm 0.2047"	20-01-22-
18		557A0026	786570	1		Joint (liège) venturi	20-01-22-
19		557A0199	786652	1		Joint silicone ventil. HMTc PV V15	20-01-22-
20		564076	564076	1		Kit d'électrodes Evo_25-35-45kW	20-01-22-
21		564043	564043	1		TUYAU FLEXIBLE MASTERFLEX D80 L515	20-01-22-
22		557A0098	786597	1		Joint vanne gaz-venturi	20-01-22-
23		A1002430	786971	1		Joint rampe brûleur HMTc PV V15	20-01-22-
24		A1002006	786803	1		Coude 45° DN80 PP	20-01-22-
25		A1005072	787430	1		Isol.brûleur Pioneer HM SO TC V15	20-01-22-