

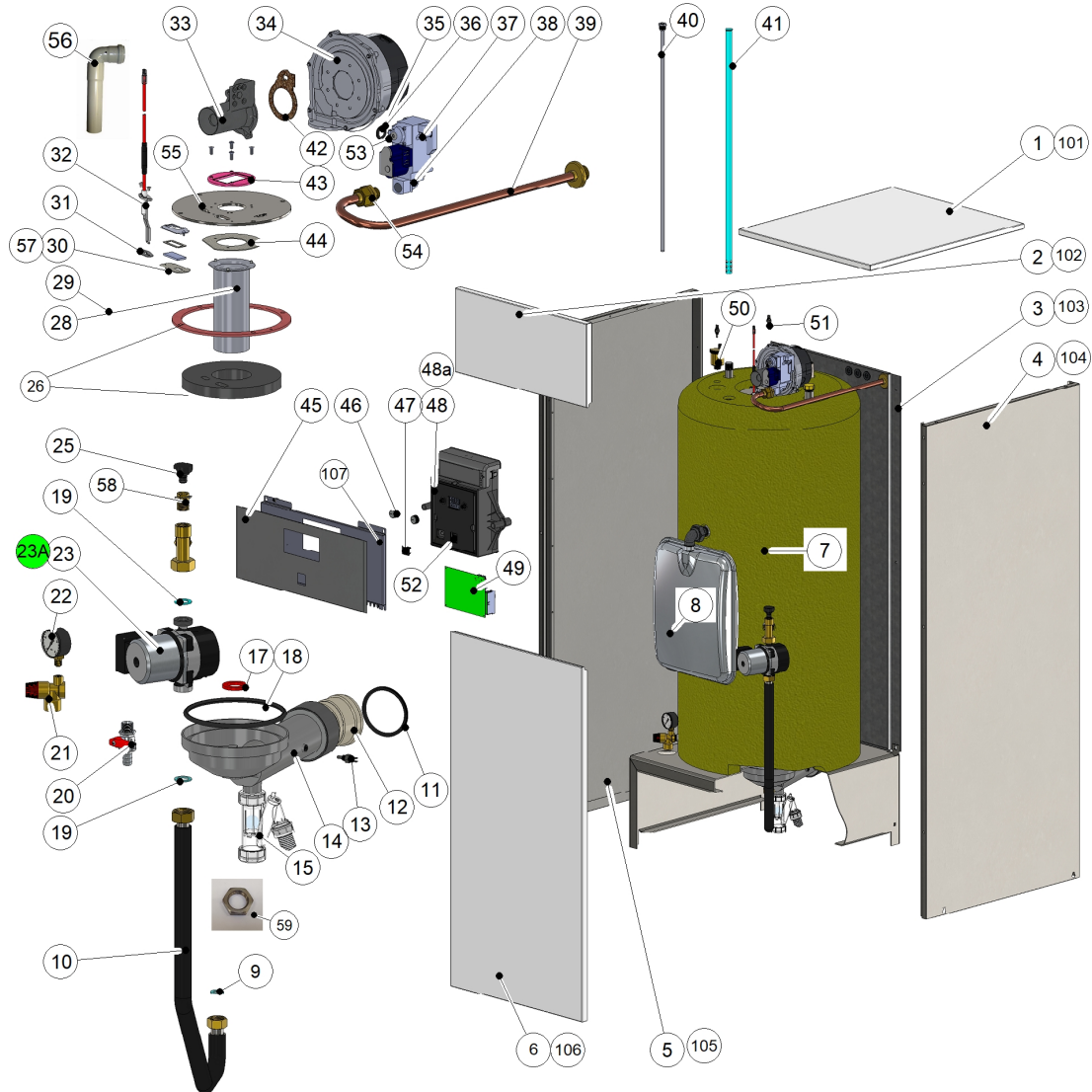











## HM25C



HM25C

Code	Code GA	Quant.	Photo	Description	De --- A ---	Remarque
0	10800265	784436	1	 Kit visserie chd.condens.		
1	21475468		1	Couvercle HM25C	01-06-10-30-06-13	
2	21478468		1	Avant sup. HM25C	01-06-10-30-06-13	
3	21474468		1	Arrière HM25C	01-06-10-30-06-13	
4	21471468	784557	1	Lat.droit HM25C (gris clair)	01-03-13-30-06-13	
5	21472468		1	Lat.gauche HM25C (gris clair)	01-03-13-30-06-13	
6	21473468	784602	1	Avant HM25C	01-06-10-30-06-13	
7	30540570	784807	1	Corps moussé HM25 C	01-06-10-	Prev: 30537570
8	557A7008	786725	1	 Vase expans.12L 3/4	01-06-10-	
9	557A0051	786581	1	 Joint 24x14x2 fibre	01-06-10-	
10	507F4208		1	 Tube de circulateur HM25C	01-06-10-	
11	557A0105	786600	2	 Joint à lèvres DN80 HR-EPDM noir	01-06-10-	
12	537D6404	786286	1	 Coude 30° MF DN80 PP gris+joint	01-06-10-	
13	5476g054	786524	1	 Sonde NTC 12K d5x50 1/8' +conn. Molex	01-06-10-	
14	10800261	784432	1	 Bac condens.PPS+joints HM35TC-25 C	01-06-10-	
15	557A8004	786727	1	 Siphon DH50+bille+bague+flexible:60cm	01-06-10-	
17	A1004464	787332	1	Joint 28-45x4 Viton bac condens.HMTC	01-06-10-	prev: 557A0073
18	557A0141	786618	1	 Joint DI:166 bac.condens.HM35TC	01-06-10-	prev: 557A0118
19	557A0050	786580	2	 Joint 30x20x2 fibre	01-06-10-	
20	55426001	785274	1	 Robinet de vidange 1/2	01-06-10-	



HM25C

Code	Code GA	Quant.	Photo	Description	De --- A ---	Remarque
21	55426017	785275	1	Soupape secur.3bar 1/2 50kW	01-06-10-	
22	54426002	785129	1	Manomètre 1/4 vertical réf.9013989	01-06-10-	
23	557A4014	786702	1	Circul.RS15/6-3KU CLF L130-6 G1 Molex	01-06-10-31-07-15	non ERP
23A	A1006375	780155	1	Assemblage UPM3 15-60 L 130 G1 & Connect	29-10-19-	ERP- prev : A1002167
25	5476V033	786550	1	Sonde de pression 0-4 bar 5250AB00	01-06-10-	
26	A1005068	787426	1	Isol.brûleur 2en1 Prest.24-32 MK2-2,75	01-10-12-30-11-18	2in1insulation - prev: A1002429 - 51700128&557a0179
28	537DZ025	786451	1	Rampe Prest.24-32 GN D:63 L:157,9	01-06-10-	Nat.gas
29	537DZ026	786452	1	Rampe NIT NIT Prest.D63 L158	01-06-10-	Propane
30	507F4283	786028	1	Kit regard flamme monobloc	01-08-13-	Prev: 507F4164
31	557a0095	786595	1	Joint électrode Prest.MK3	01-06-10-	
32	537DZ038	786460	1	électrode P18-32 Mk3 céram.longue	01-01-12-	prev: 537DZ036
33	537D4034	786131	1	Venturi VF002	01-06-10-	
34	537D3049	786109	1	Ventil. RG128-1300-3612 230V	01-06-10-	
35	557A0098	786597	1	Joint vanne gaz-venturi	01-06-10-	
36	537D4020	786126	1	-OBS- Opercule 5,2mm->537D4082	01-06-10-	-Obsolete-Propane- HotSpot : 36
37	537D4009	786121	1	Vanne gaz VK4115V1014	01-06-10-	
38	53402086	785025	1	Bride coudée vanne gaz 1/2 +o-ring	01-06-10-	
39	507F4206	786004	1	Tube gaz HM25C	01-06-10-	
40	39438027	784821	1	Doigt de gant inox 1/2x500	01-06-10-	
41	49410045	784899	1	Plonge PVCc 19,5x800 ouverte	01-06-10-	



HM25C

Code	Code GA	Quant.	Photo	Description	De --- A ---	Remarque
42	557A0026	786570	1	Joint (liège) venturi	01-06-10-	
43	557A0054	786583	1	Joint bride ventil.Prest.	01-06-10-	
44	A1002407	786963	1	Joint rampe Prest.24-32 V14	30-11-18-	Prev: 557A0048-557A0153
45	21476468	784658	1		Panneau inox HM25C	01-06-10-
46	54764028	785218	2	Bouton rotatif Prest.Mk3	01-06-10-	
47	54766030	785241	1	Capot interrupteur I/O Prest.V14	01-01-15-	prev: 54766029
48a	537d8138	786398	1	Circ.impr.display LCD Prest.MK3		
48	5476g059	786527	1	Set boîtier+display ESYS remplacement	01-06-10-	
49	5476g058	786526	1	ESYS réglé HM25C	01-06-10-	
50	557A3001	786695	1	Purgeur air auto.1/2 laiton	01-06-10-	
51	5476G047	786519	2	Sonde NTC 12K d5x18 1/8 +Molex conn.	01-06-10-	
52	54766027	785239	1	Interrupteur on/off 2P 16A/250VAC MK3	01-06-10-	
53	53437039	785089	1	Prise de pression D:8,5 M5	01-06-10-	
54	557A0161	786633	1	Joint gaz 23,5x17x2 NBR 80 ShA EN682		
55	507F4095	785961	1	Plaque brûleur Prest.24-32 HMTC		
56	497B0025	785854	1	Silencieux Prest.24-32-50-75 MK2		
57	557A0149	786623	1	Joint regard flamme monobl(68x32x2 GPE)		
58	507F4207	786005	1		Raccord+epingle capteur pression HM25C	01-03-15-
59	4779A011	785844	1	Ecrou 3/4 DIN431A inox HMTC	01-06-10-	
99	257F1125	785781	1	Câblage HM25 C	01-06-10-	



HM25C

Code	Code GA	Quant.	Photo	Description	De --- A ---	Remarque
99	547D3018	786561	1	 Sonde NTC 12K L1500 pour ballon	01-06-10-	
101	21475489	784638	1	Couvercle HM25C V13	30-06-13-	
102	21478489	784682	1	Avant sup. HM25C V13	30-06-13-	
103	21474489		1	Arrière HM25C V13	30-06-13-	
104	21471489	784561	1	Lat.droit HM25C (BLANC)	30-06-13-	
105	21472489	784581	1	Lat.gauche HM25C (BLANC)	30-06-13-	
106	21473489	784606	1	Avant HM25C V13	30-06-13-	
107	20477468		1	Tableau (tôle) HM25C		