

Panels HM71

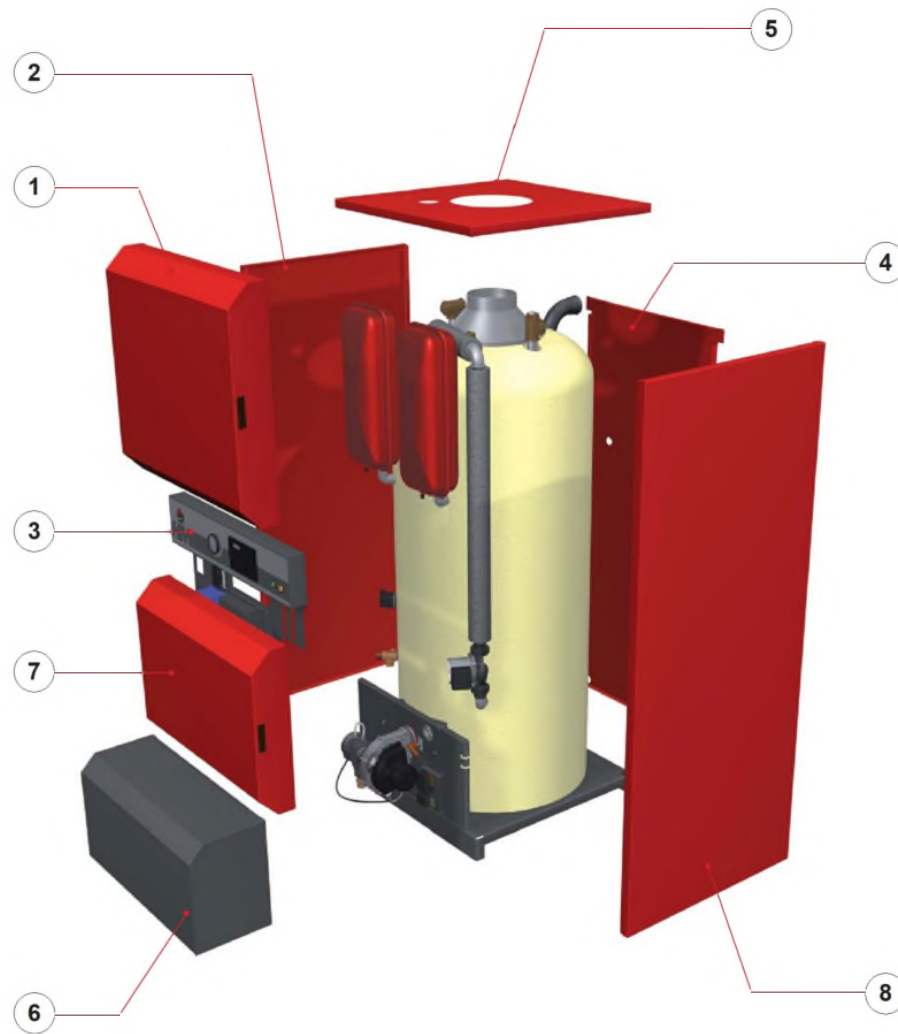



Panels HM71





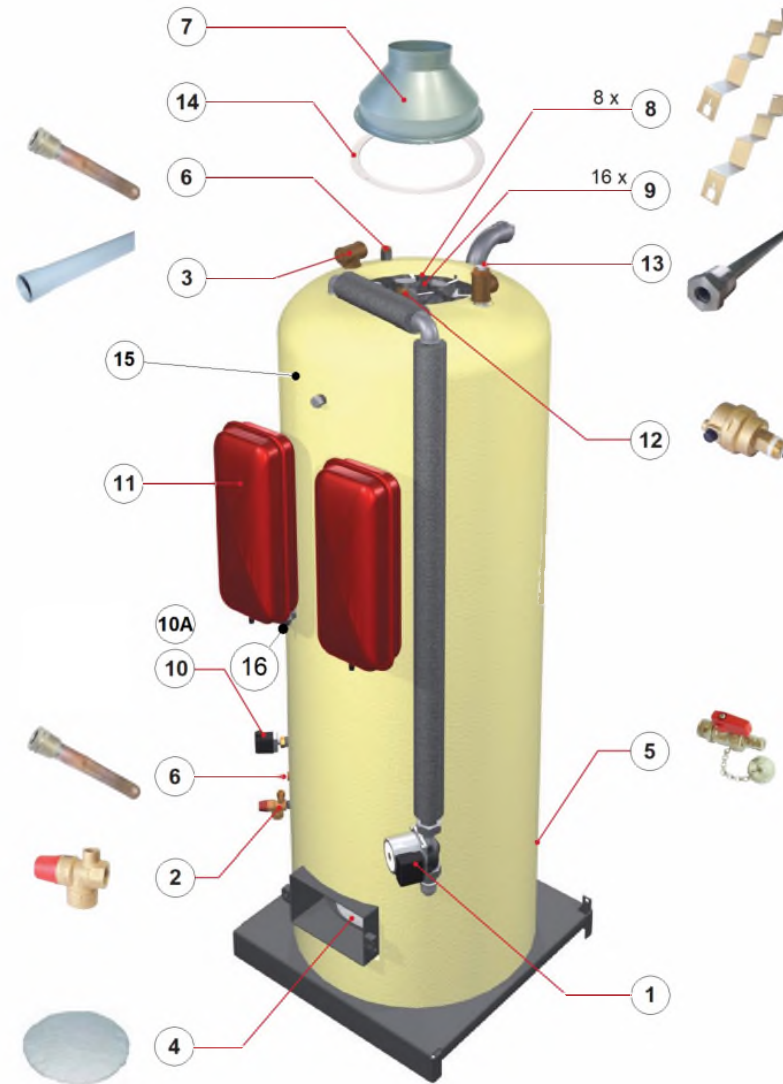













Code	Code GA	Quant.	Description	From --- To ----	Remark
1		1	Front panel upper HM70-71 (red)		
2		1	Side panel LH HM70-71		
3		1	Control panel HMN - 71 - 101 / BG2000		
4		1	Rear panel HMN 71 - BG2000		
5		1	Top panel HM70-71-100-101 (red)		
6	784653	1	Burner cover HM71-101 BG2000		
7		1	Front panel lower HM70-71-100-101 (red)		
8		1	OBS- Side panel RH HM70-71	-18-11-20	Obsolete -Jaquette

Internal HM71





Internal HM71

Code	Code GA	Quant.	Picture	Description	From --- To ----	Remark
1	557A4009	786700	1	 Pump RS25/6-3 L130-3 G6/4		
2	557A1076	786682	1	 Safety valve 3bar 100kW 1/2	01-02-13-	Prev: 55426017
3	497B0001	910423	1	 Sparge tube PVCc 25x950		
4	51700093	784989	1	 Insul.blanket D430x13 - 128kg/m³	01-10-12-	prev: 51305000
5	55426001	785274	1	 Drain cock 1/2		
6	5476g002	786490	1	 NTC sensor 12k duplo L:2400 mm		
6	63438001	785296	1	 Dry well brass 1/2x100 3 bulbs		
7	507F3033	785935	1	 Flue hood 290- >DN150 mm F45/HM		
8	507F2009	785930	8	 Turbulator upper HM type A		
9	507F2010	785931	16	 Turbulator lower HM type B		
10	557A1056	786672	1	 -OBS- Low pressure switch 1/4 0,5-0,8 bar	-31-12-15	Prev : 557A1056
10A	A1002747	787022	1	 Low press.switch 1/4 CEME	01-01-16-	
11	557A7006	786723	2	 Exp.vessel 10L CH		
12	55445007	785283	1	 Air vent auto.3/8 with non-ret.valve		
13	39438046	784824	1	 Dry well SST 1/2x950		
13	5476G003	786491	1	 NTC sensor 12k L:3200mm for tank		
14	557A0156	786630	1	 Gasket draft hood De:325 Di:290 Dh:310	01-10-12-	Prev: 557A0016
15	30540367	784797	1	 Body foamed HM70-71		
16	42716007	784844	2	 Rotary elbow mf3/4 fig.97 steel		

Control panel HM71

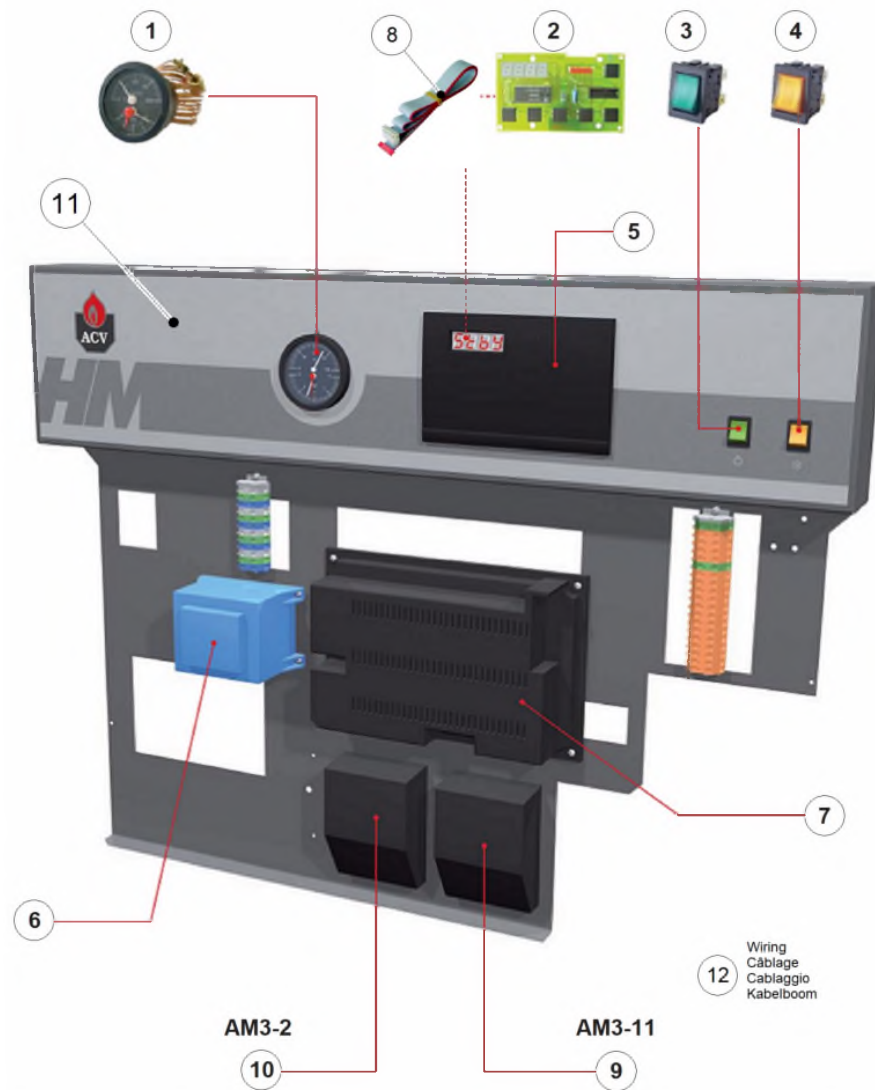



Control panel HM71

Code	Code GA	Quant.	Picture	Description	From --- To ----	Remark
1	025007	1		Combined T°/Manometer 0-4 bar 0-120°C		Prev : 54441008 -Tableau électrique
2	537D3020	786091	1		Display for MCBA	
3	54766016	785234	1		Switch 2P green	
4	54766017	785235	1		Switch 2P yellow	
5	537D3023	786092	1		Display box Hoval EBV 16.9910906013	
6	547D3021	786562	1		Transfo.230/24V 72VA+ cable 35cm MCBA	
7	537D8037	786378	1		MCBA preset for HM71	
8	257F1079	785764	1		Ribbon cable display to MCBA	
9	10800095	784375	1		Kit second heating circuit AM3-11	OPTION
10	10800094	784374	1		Kit alarm module AM3-2	OPTION
11	24614113	784707	1		Contr.pan.cpl HM101	-01-11-13
11	24614206	784720	1		Contr.pan.cpl HM71-101 (V13)	01-11-13-
12	257F1109		1		Cabling HM71-101	-01-11-13

Bumer HM71

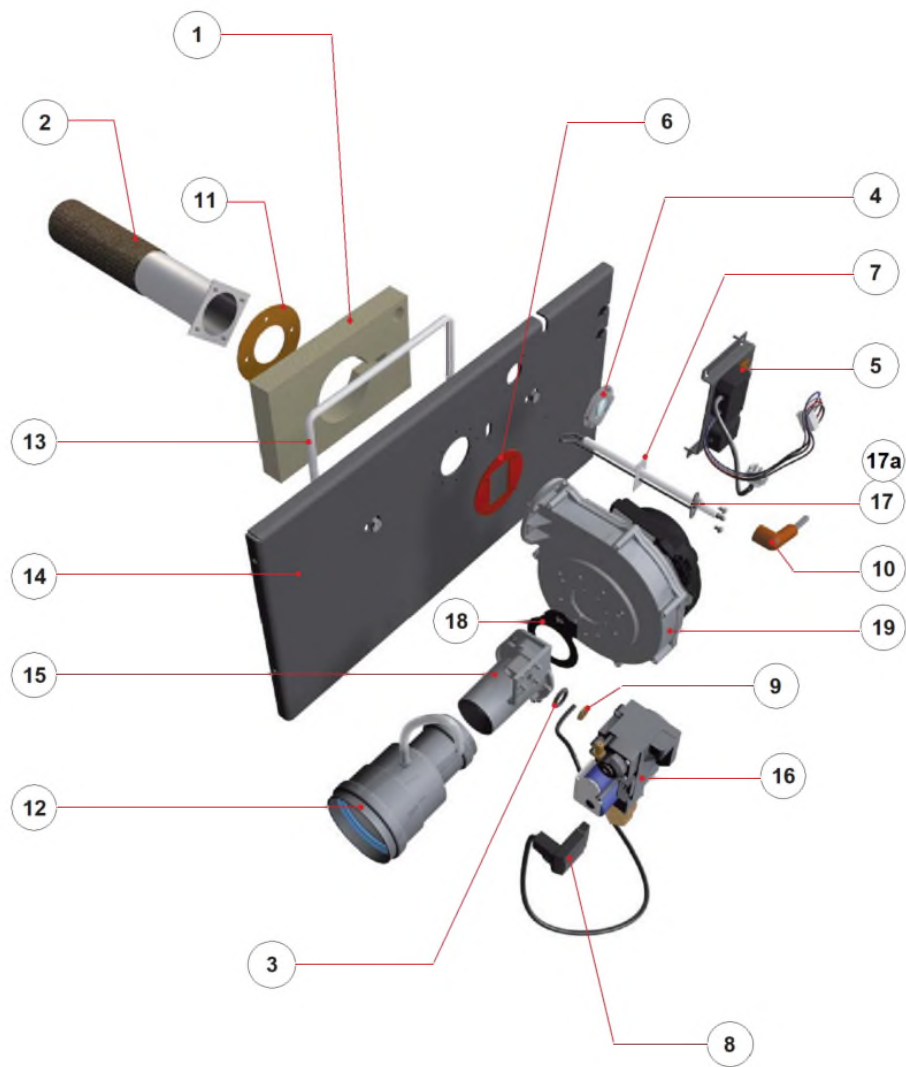





Burner HM71

Code	Code GA	Quant.	Picture	Description	From --- To ----	Remark
51700034		1		OBS- Insul.door BG2000 60-70-71 + USA	-31-08-09	- Obsolete - HotSpot n°1
1 51700102	784995	1		Insul.burner door BG2000 Delta Pro-HM	01-10-12-	Prev: 51700078
2 537DZ029	786455	1		Burner head NIT D:63 L:313,5 HM		
3 557A0098	786597	1		Gasket venturi-gas valve		
4 50423365	784922	1		Sight glass Furigas (assembly)		
4 557A0155	786629	1		Gasket kerlane Ø44x28x2	01-10-12-	Prev: 55412000
5 257F1108	785776	1		Cabling burner HM71		
6 55700026	785284	1		Gasket for fan BG2000		
7 557A0163	786635	1		Gasket électrode dual ceramic	01-10-12-	Prev: 557A0012
8 537D3016	786089	1		Rectifier 24V 45900446.051B		
9 537D4037	786132	1		Orifice 6,8mm (VF051 G31)		
10 257F1071	785759	1		Ignition cable 780mm Prest.		Prev : 257F1073 Tableau électrique
11 55700028	785285	1		Gasket burner tube BG2000 (Ø107x1mm)	01-10-12-	Prev: 55412000
12 537D6135	786190	1		Reducer FF 80x50 for air inlet		
13 51700025	784980	1		Cord D:10mm (per meter)		
14 21479369	784688	1		Burner door HM71		
15 537D4028	786129	1		Venturi VF051		
16 537D4033	786130	1		Gaz valve VK8115V1036		
17a 537DX029	786438	1		électrode 215-15-LH dual ceram.	-01-01-13	V09 only
17 537DX032	786440	1		électrode 185-10-LH dual ceram.	01-01-13-	from V013



Bumer HM71

Code	Code GA	Quant.	Picture	Description	From --- To ----	Remark
18 557A0026	786570	1		Gasket (cork) for venturi		
19 537D3027	786095	1		Fan RG148-1200-3612 without potent.		