

Panels HM201 V13

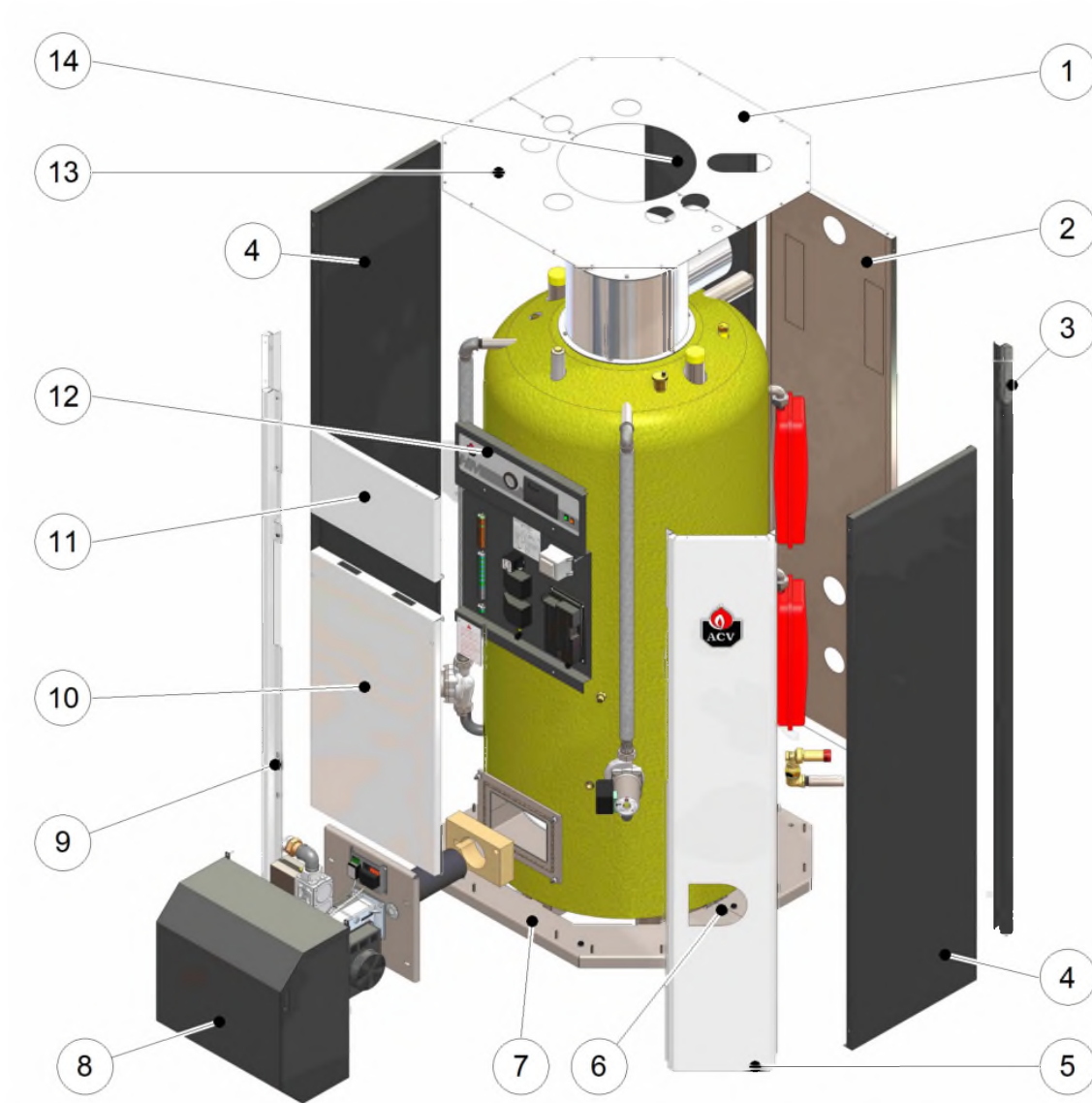



Panels HM201 V13

☐	Code	Code GA	Quant.	Description	From --- To ----
1	21475505		1	Top panel rear HM200-201 (white V13)	01-07-14-
2	20474505		1	Rear panel HM200-201 (galva V13)	01-07-14-
3	21478505		1	Corner panel rear RH HM200-201 (Grey)	01-07-14-
4	21471505	784568	2	Side panel LH&RH HM200-201 (grey V13)	01-07-14-
5	21472505	784588	1	Corner panel front RH HM200-201 whiteV13	01-07-14-
6	21480024	784695	2	Junction base plates J800-1000 & HM200	01-07-14-
7	2147S415	785733	2	Base plate HM201-200F-200N (half)	01-07-14-
8	21476416	784654	1	Burner cover HM201	01-07-14-
9	21479505	784694	1	Corner panel front LH HM200-201 whiteV13	01-07-14-
10	2147B505	785713	1	Front panel lower HM200-201 (white V13)	01-07-14-
11	2147A505		1	Front panel upper HM200-201 (white V13)	01-07-14-
12	21477416		1	Control panel (plate) HM201	01-07-14-
13	21475506		1	Top panel front HM200-201 (white V13)	01-07-14-
14	21473415		1	Corner panel rear LH HM200-201 (Grey)	01-07-14-

Control panel HM201

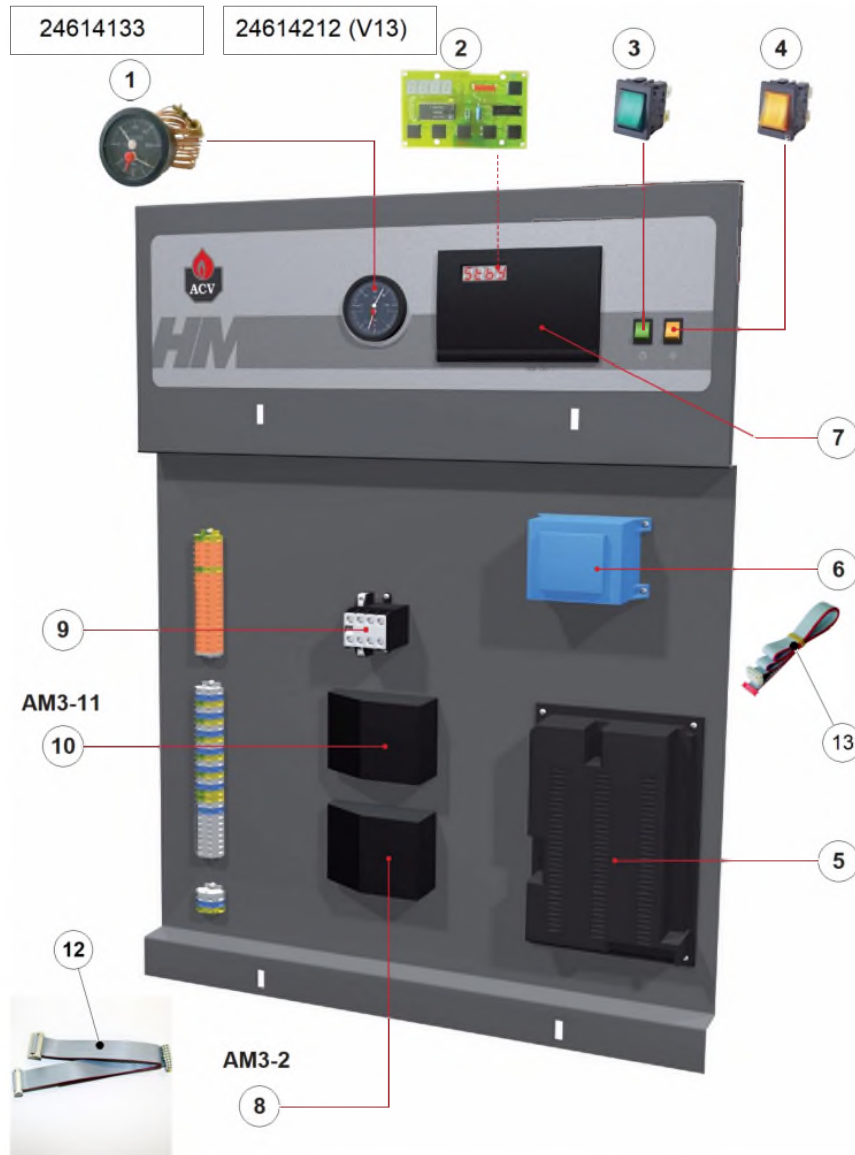



Control panel HM201





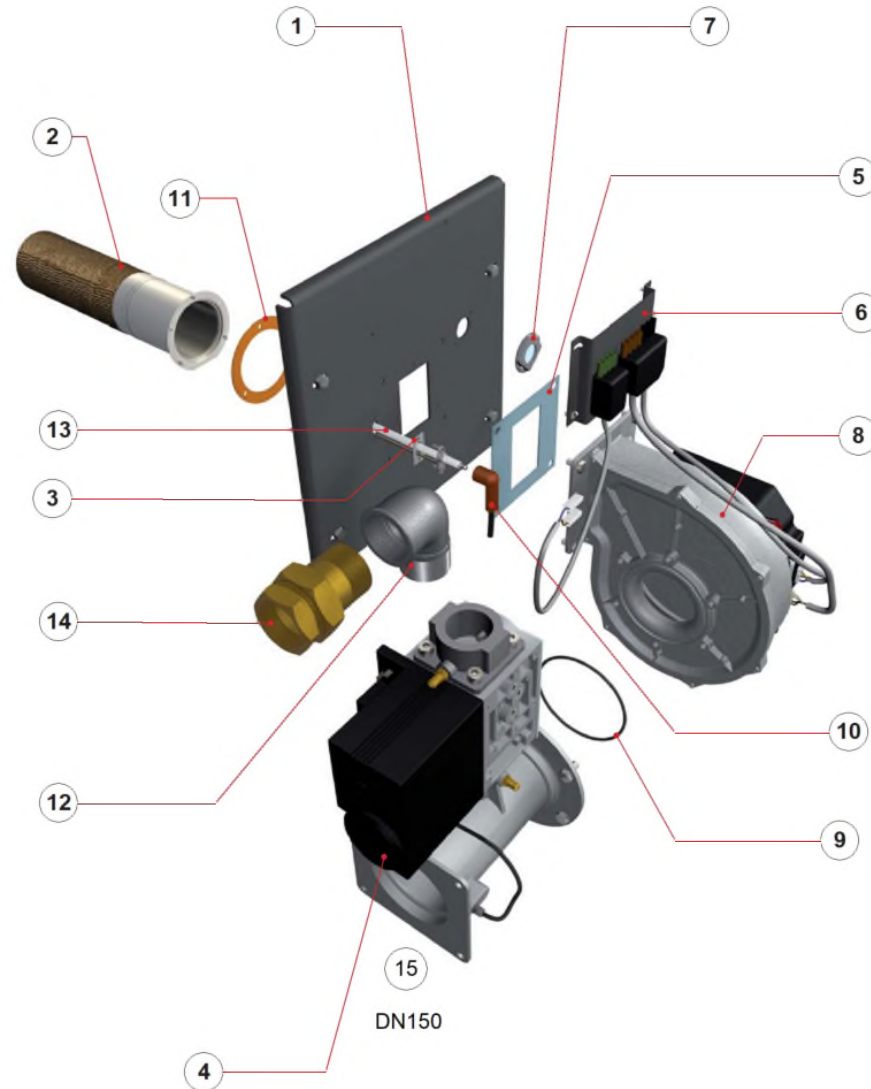







Code	Code GA	Quant.	Picture	Description	From --- To ----	Remark
1	025007	1		Combined T°/Manometer 0-4 bar 0-120°C		Prev : 54441008 -Tableau électrique
2	537D3020	786091	1		Display for MCBA	
3	54766016	785234	1		Switch 2P green	
4	54766017	785235	1		Switch 2P yellow	
5	537D8039	786380	1		MCBA preset for HM201	
6	547D3021	786562	1		Transfo.230/24V 72VA+ cable 35cm MCBA	
7	537D3023	786092	1		Display box Hoval EBV 16.9910906013	
8	10800094	784374	1		Kit alarm module AM3-2	
9	54452082	785179	1		Relay 3TG 1010-OAL2	
10	10800095	784375	1		Kit second heating circuit AM3-11	
11	24614133		1		Contr.pan.cpl HM201	
12	10800098	784376	1		Ribbon cable MCBA to AM	
13	257F1079	785764	1		Ribbon cable display to MCBA	
14	24614212	784722	1		Contr.pan.cpl HM201 (V13)	01-07-13- V13

Burner HM201





Burner HM201





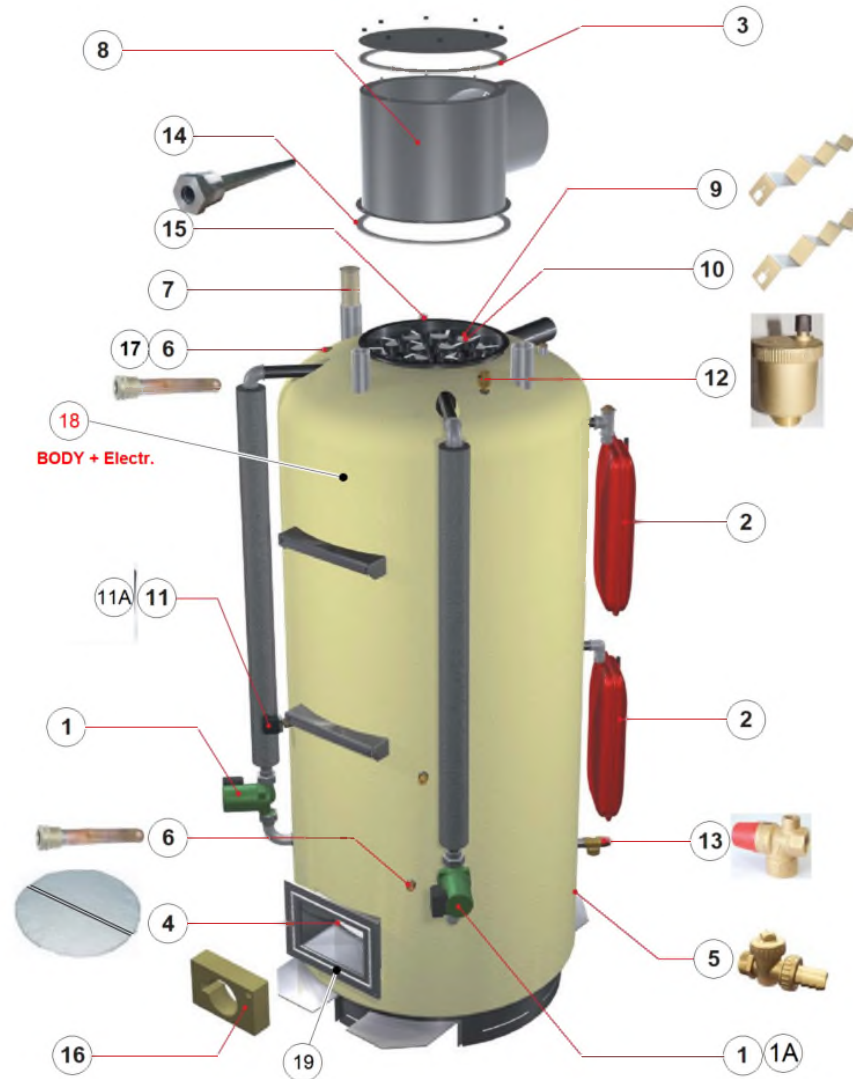









Code	Code GA	Quant.	Picture	Description	From --- To ----	Remark	
1	2147P416	785730	1		Burner door HM201		
2	537DZ019	786448	1		Burner head NIT 98x372		
3	557A0163	786635	1		Gasket électrode dual ceramic	01-10-12-	Prev: 557A0012
4	537D8022	786366	1		Kit gas valve with venturi for HM201		
5	557A0040	786578	1		Gasket fan to door HM201		
6	257F1105	785774	1		Cabling burner HM201		
7	50423365	784922	1		Sight glass Furigas (assembly)		
7	557A0155	786629	1		Gasket kerlane Ø44x28x2	01-10-12-	Prev: 55412000
8	537D3034	786097	1		Fan for HM201		
9	557A0045	786579	1		O-ring 110x3,5		
10	257F1069	785758	1		Ignition cable 1200mm HM201		
11	557A0020	786567	1		Gasket burner head BG2000S-100 HM101-201		
12	42714000	784842	1		Elbow MF 5/4 steel fig.92		
13	537DZ045	786465	1		électrode 185-15-RH dbl.ceram	01-06-14-	Prev: 537DX021
14	43726007	784854	1		Coupling (3 part) 6/4 to 18mm		
15	10800157	784391	1		Kit Air supply for HM201 (DN150)		OPTION

Internal HM201





Internal HM201

Code	Code GA	Quant.	Picture	Description	From --- To ----	Remark
1	557A4025	786707	2	 Pump Top-S 25/7 L180 G6/4 grey	-31-12-19	non ERP
1A	A1006377	780157	0	Assembly UPML 25-105 L180 G1.5&Connector	29-10-19-	ERP Prev : A1002169
2	55301200	785263	4	 Exp.vessel 8L.(long shape)		
3	557A0157	786631	1	Gasket upper flue box HM200- 201 380/320	01-10-12-	Prev: 557A0059
4	51700094	784990	2	 Insul.sheet (1/2 disk) D680x13 HM201	01-10-12-	Prev: 51700041
5	557A1000	786653	1	Drain cock 3/4		
6	63438001	785296	1	 Dry well brass 1/2x100 3 bulbs		
7	497B0502	785869	1	Sparge tube PVCc 50x1300 unplug.		
8	507F3044	785942	1	Flue hood horiz.HM200- 201		
9	507F2009	785930	15	 Turbulator upper HM type A		
10	507F2010	785931	45	 Turbulator lower HM type B		
11	557A1056	786672	1	 -OBS- Low pressure switch 1/4 0,5-0,8 bar	-31-12-15	Prev : 557A1056
11A	A1002747	787022	1	 Low press.switch 1/4 CEME	01-01-16-	
12	557A3001	786695	1	 Air vent auto.1/2 brass		
13	557A1070	786680	1	 Safety valve 3bar 247kW 3/4	01-07-12-	
14	557A0158	786632	1	 Gasket lower flue box HM200- 201 410/376	01-10-12-	Prev: 557A0055
15	39438030	784822	1	 Dry well SST 1/2x1300		
15	5476G003	786491	1	 NTC sensor 12k L:3200mm for tank		
16	51700105	784998	1	Insul.burner door HM201	01-10-12-	Prev: 51700040
17	5476g002	786490	1	 NTC sensor 12k duplo L:2400 mm		



Internal HM201

Code	Code GA	Quant.	Picture	Description	From --- To ----	Remark	
18	27300086	784740	1		Body+accessories HM201	01-01-14-	
19	51700025	784980	1		Cord D:10mm (per meter)		