

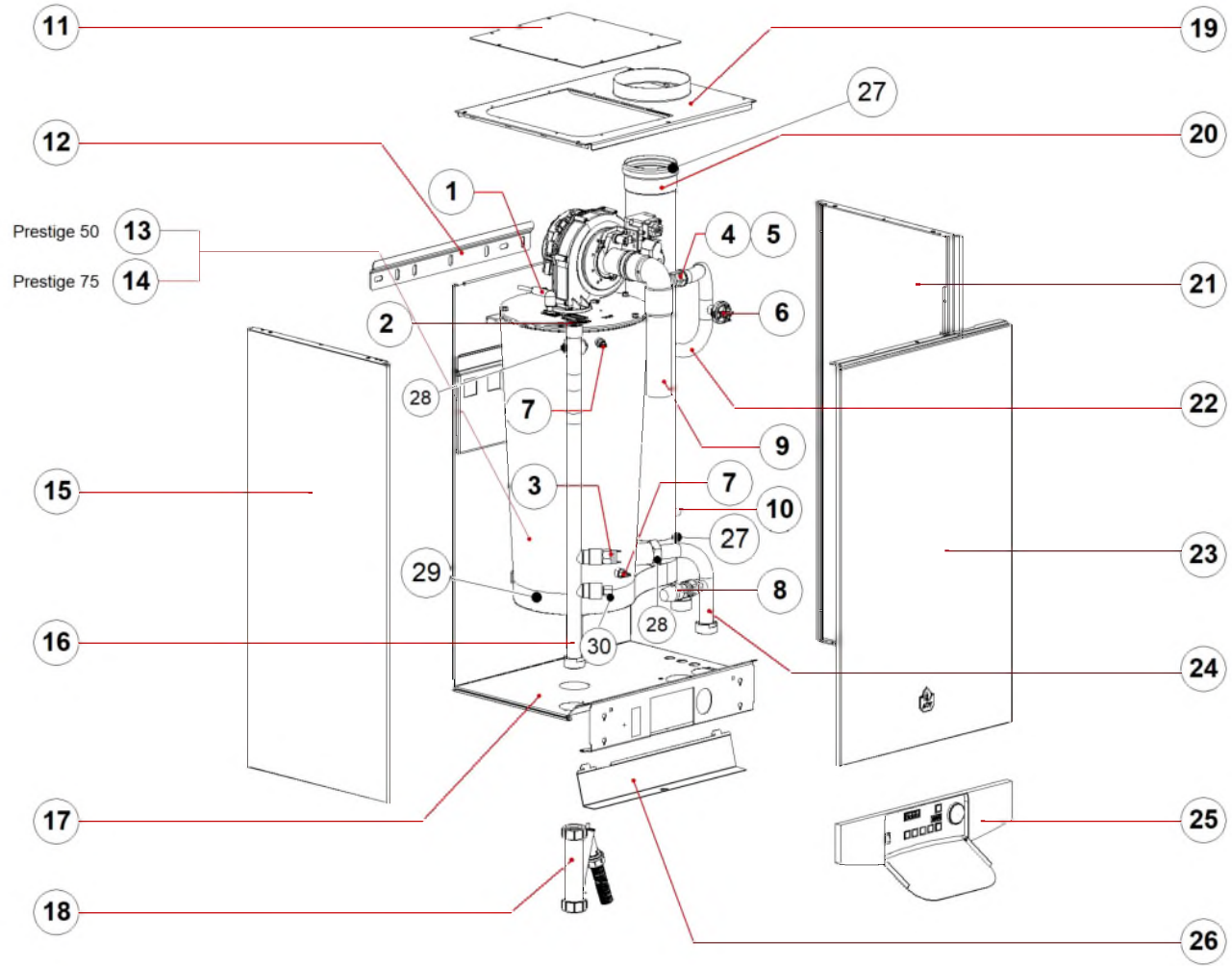













Prestige 50-75 MK2











Prestige 50-75 MK2

Code	Code GA	Quant.	Photo	Description	De --- A ---	Remarque
1	257F1071	785759	1	 Câble allumage 780mm Prest.		
2	557A3001	786695	1	 Purgeur air auto.1/2 laiton		
3	55439129	785280	1	 Pressostat manque 1/2 0.5bar +/-0.2bar		
4	43416134	784849	1	 Coude 1/2' M/F laiton		
5	43720000	784851	1	 Manchon réduit FM 3/4x1/2 laiton		
6	537DC000	786426	1	 Pressostat gaz Prest.-HMTC		
7	5476G008	786492	1	 Sonde NTC 12K d5x18 1/8 +faston		
8	557A1057	786673	1	 Soupape secur.4bar 3/4		
9	497B0025	785854	1	 Silencieux Prest.24- 32-50-75 MK2		
10	5476G036	786510	1	 Sonde NTC 12K d5x50 1/8 BSP faston		
11	2147C423	785715	1	Fermeture jaq.supérieur Prest.50-75		
12	21480069	784696	1	 Fixation murale Prest.(S&E)		
13	63962019		0	Echangeur P50->27300073	-31-12-11	New: 27300073
13	27300073	784737	1	 Echangeur P50 +bac condens.PP	01-01-12-	Prestige 50
14	63962020		0	Echangeur P75->27300074	-31-12-11	New: 27300074
14	27300074	784738	1	 Echangeur P75 +bac condens.PP	01-01-12-	Prestige 75
15	21471440	784554	1	Lat.G&D Prest.Solo MK2 (V07)		
16	507F4104	785963	1	Tube B départ échangeur Prest.50-75		
17	21474442		1	Arrière&Inférieur Prest.50-75 V07 OBS	-01-01-18	obsoleted 2018
18	A1003131	787100	1	 Siphon DH90+bille+bague+joint	01-10-16-	PREV 557A8005



Prestige 50-75 MK2





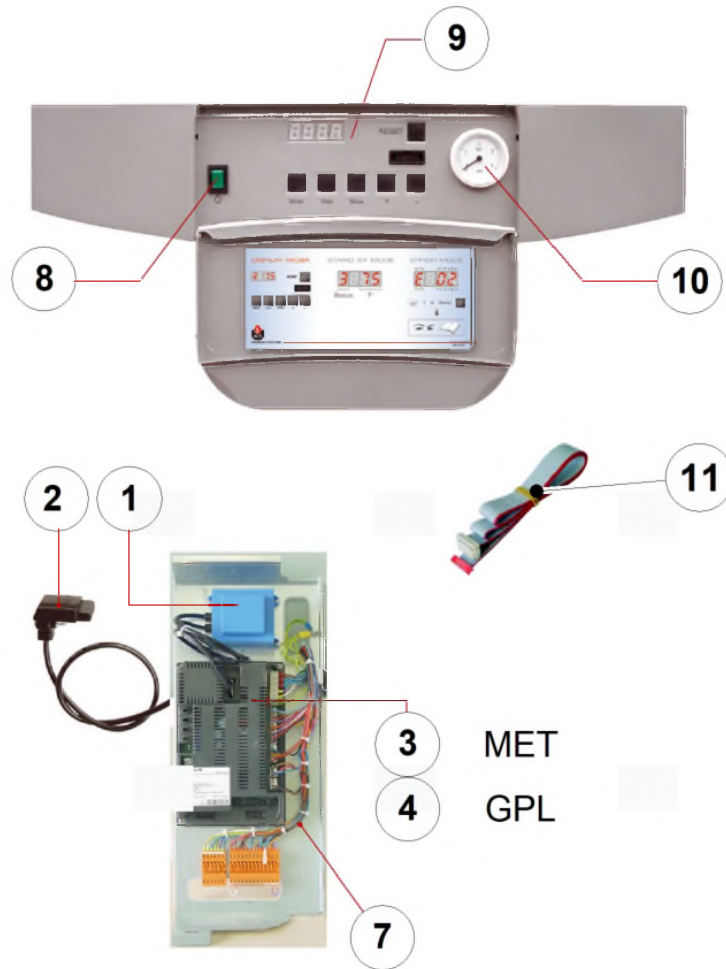







Code	Code GA	Quant.	Photo	Description	De --- A ---	Remarque
19	21475442	784631	1		Supérieure Prest.Solo 50-75	
20	497B0035	785861	1		Tube fumée D:100 L:815 Prest.50-75	
21	21471440	784554	1		Lat.G&D Prest.Solo MK2 (V07)	
22	507F4106	785965	1		Tube gaz Prest.50-75	
23	21473440		1		Avant Prest.Solo MK2 (V07)	
24	507F4105	785964	1		Tube A retour échangeur Prest.50-75	
25	54761008	785184	1		Tableau Prest.	
26	2147E419		1		Ecran tableau Prest.Solo MK2	
27	557A0106	786601	2		Joint à lèvres DN100 HR-EPDM noir	
28	557A0067	786586	2		Joint fibres 38x30x2 (1"1/4)	
29	10800310	784484	1		Kit rempl.bac condens.P50-75	01-01-12-
30	557A5005	786717	1		Raccord manomètre 1/4 +clap.AR	
99	24614138		1		Tableau cpl Prest.50-75	

Controls Prestige 50-75 MK2





Controls Prestige 50-75 MK2





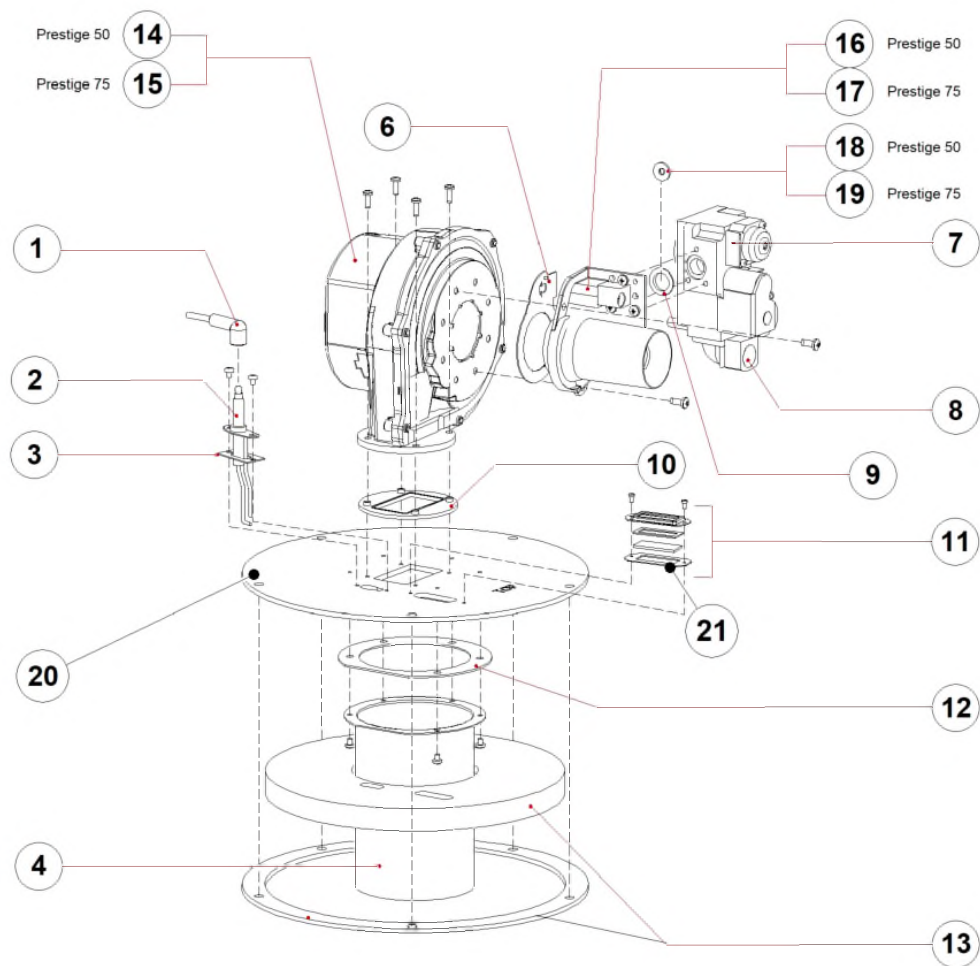















		Code	Code GA	Quant.	Photo	Description	Remarque
1		547D3021	786562	1		Transfo. 230/24V 72VA+ câble 35cm MCBA	
2		537D3039	786102	1		Rectificateur 24V L.1260 45900441-023B	
3		5476G030	786506	1		MCBA réglé Prest.50 Solo Gaz Naturel	50 kW Nat.gas
3		5476G032	786508	1		MCBA réglé Prest.75 Solo Gaz Naturel	75 kW Nat.gas
4		5476G031	786507	1		MCBA réglé Prest.50 Solo propane	50 kW Propane
4		5476G033	786509	1		MCBA réglé Prest.75 Solo propane	75 kW Propane
7		257f1095	785767	1		Câblage P50-75 MK2	
8		54766016	785234	1		Interrupteur 2P vert	
9		537D3020	786091	1		Circuit clavier pour MCBA	
10		54763017	785201	1		Manomètre 0-4 bar 60psi Ø37mm noir	
11		257F1079	785764	1		Câble plat display vers MCBA	
99		5476V000	786539	1		Levier connecteur orange	

Burner Prestige 50-75 MK2





Burner Prestige 50-75 MK2

Code	Code GA	Quant.	Photo	Description	De --- A ---	Remarque
0	10800288	784460	1	 Kit électrode Prest.MK2 + vis+joint		
1	257F1071	785759	1	 Câble allumage 780mm Prest.		
2	10800288	784460	1	 Kit électrode Prest.MK2 + vis+joint	01-01-13-	prev: 537DZ033
3	557a0095	786595	1	 Joint électrode Prest.MK3		
4	537DZ027	786453	1	 Rampe NIT Prest.50-75 D:98		
6	557A0026	786570	1	 Joint (liège) venturi		
7	537D4033	786130	1	 Vanne gaz VK8115V1036		
8	53402086	785025	1	 Bride coudée vanne gaz 1/2 +o-ring		
9	557A0098	786597	1	 Joint vanne gaz-venturi		
10	557A0054	786583	1	 Joint bride ventil.Prest.		
11	507F4283	786028	1	 Kit regard flamme monobloc	01-08-13-	Prev: 507F4164
12	A1002410	786965	1	 Joint.rampe P42>75 155>250 V14	01-10-12-	Prev: 557A0154 - 557a0065
13	A1005071	787429	1	 Isol.brûleur 2en1 Prest.50-75 MK2-2,75	01-03-18-	Prev: A1003352 51700126-51700099-557A0176-557A0066
14	537D3027	786095	1	 Ventil.RG148- 1200-3612 sans potent.		Prestige 50
15	537D3033	786096	1	 Ventil. RG148-3633 230V		Prestige 75
16	537D6038	786187	1	 Venturi VF001		Prestige 50
17	537D4028	786129	1	 Venturi VF051		Prestige 75
18	537D4013	786124	1	 Opercule 6mm (VF001 G31)		Prestige 50
19	537D4037	786132	1	 Opercule 6,8mm (VF051 G31)		Prestige 75
20	507F4103	785962	1	 Porte brûleur Prest.50-75 MK2		



Burner Prestige 50-75 MK2

🗨	Code	Code GA	Quant.	Photo	Description	De --- A ---	Remarque
21	557A0149	786623	1		Joint regard flamme monobl(68x32x2 GPE)		