

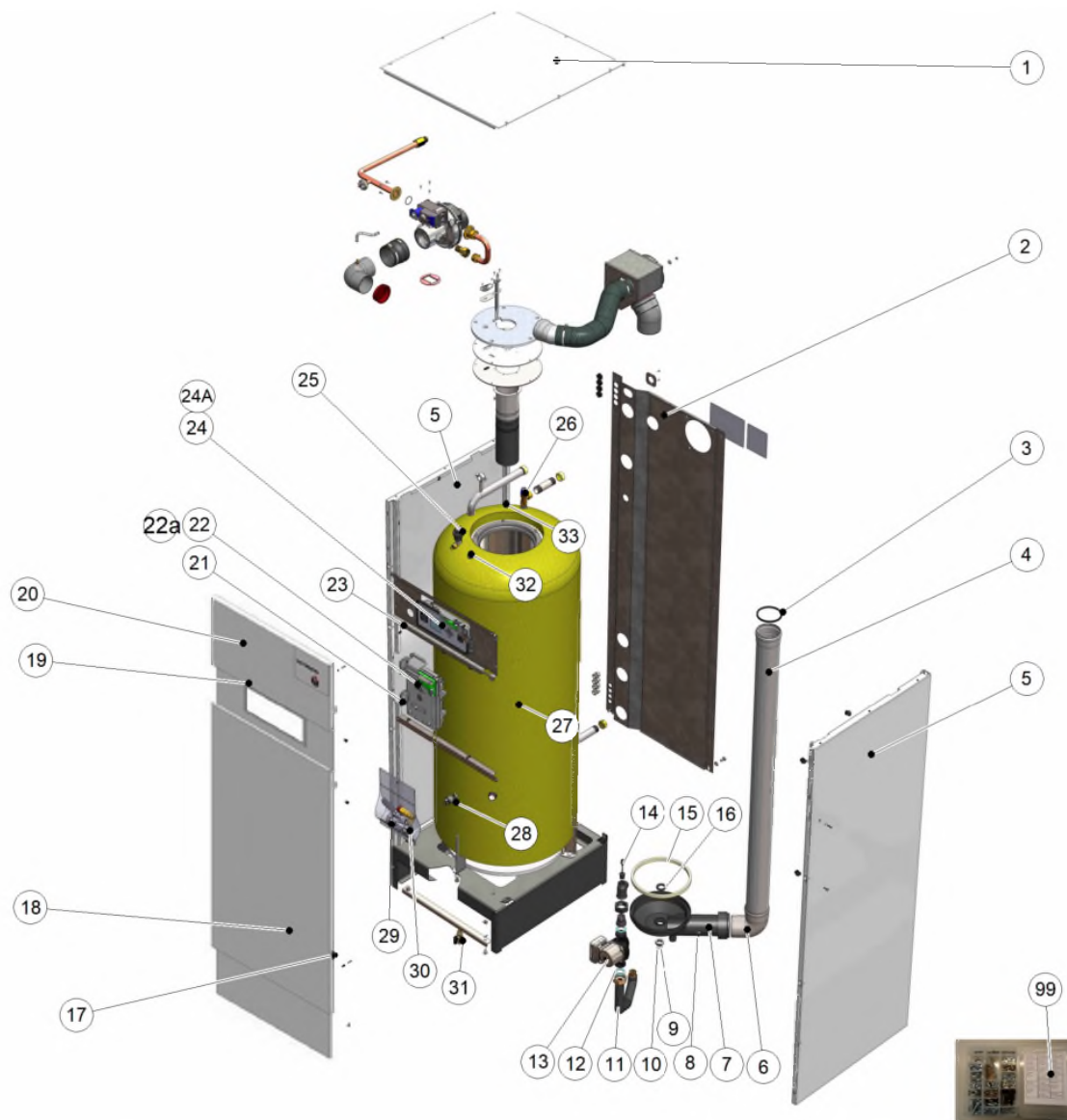











WaterMaster 120



















## WaterMaster 120

Code	Code GA	Quant.	Photo	Description	De --- A ---	Remarque
99	10800265	784436	1	 Kit visserie chd.condens.	01-11-15-	
1	21475513	784646	1	Couvercle HMTC grand V15	01-11-15-	
2	28474513	784765	1	Arrière HMTC 70-85-120 V15 équipé	01-11-15-	
3	557A0106	786601	1	 Joint à lèvres DN100 HR-EPDM noir	01-11-15-	
4	497B6047	785925	1	Tube fumée PP DN100 L1580 HMTCgrand	01-01-16-	
5	28471513	784750	2	Lat.G&D cpl HMTC grand V15	01-01-16-	
6	537D6438	786295	1	Coude 90° MF DN100 PP gris+joint	01-01-16-	
7	10800262	784433	1	 Bac cond. HMTC grand + joints	01-01-16-	
8	5476g054	786524	2	 Sonde NTC 12K d5x50 1/8' +conn. Molex	01-01-16-	
9	4779A011	785844	1	 Ecrou 3/4 DIN431A inox HMTC	01-01-16-	
10	557A0147	786622	1	 Joint 24x14x2 novapress basic	01-01-16-	
11	507F4347	786059	1	 Tube de recirculation HMTC grand V15	01-01-16-	
12	55412047	785269	2	 Joint 44-30x2 néoprène	01-01-16-	
13	557A4035	786714	1	 Circul. UPML 25 105 L180 G6/4	01-01-16-	
14	5476g054	786524	2	 Sonde NTC 12K d5x50 1/8' +conn. Molex	01-01-16-	
15	557A0145	786621	1	 Joint DI:250 bac.condens.HM85TC	01-01-16-	
16	557A0144	786620	1	 Joint 28-45x5 Viton bac condens.HMTC	01-01-16-	
17	A1006385	780159	1	Panneau avant assy HMTC large V15	01-01-16-	
18	28473513	784761	1	Avant inf.cpl HMTC grand V15	01-01-16-	
19	025009		1	Avant tabl.HMTC grand V15	01-01-16-	Prev : 21477513



## WaterMaster 120





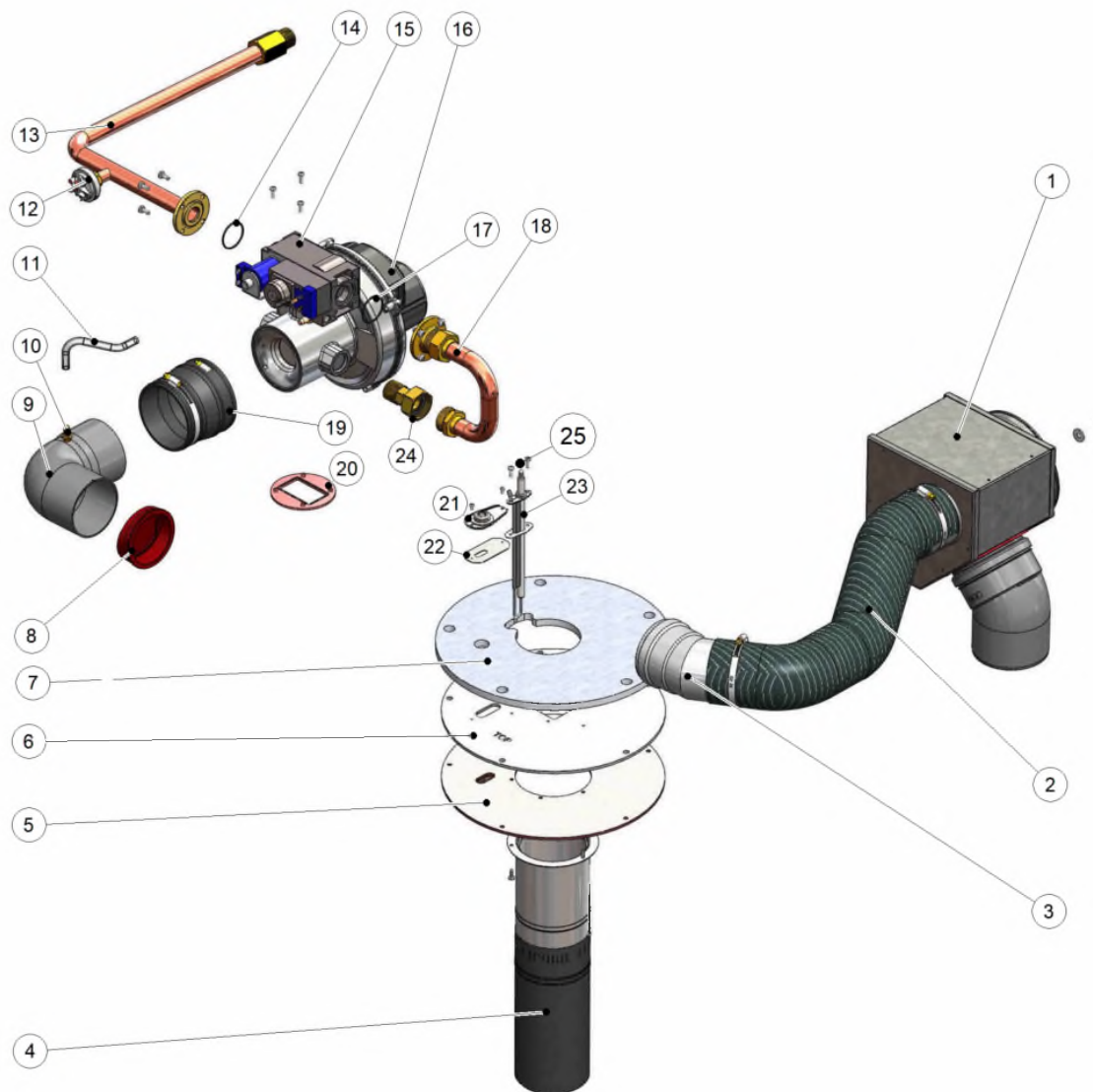







Code	Code GA	Quant.	Photo	Description	De --- A ---	Remarque
20	A1002149	1		Avant sup. WaterMaster GV (compl)	01-01-16-	
21	5476V056	786553	1	 Charnière boîtier élec. Prest.V14	01-01-16-	
22a	A1003599	787222	1	 Circ.impr.ACVMAX 230V (E) S4962S3038B	01-10-16-	
22	A1003602	787224	1	Tableau complet HM Large TC V15 Vers.2	01-10-16-	
23	2847M513	785804	1	Support display cpl HMTC grand V15	01-01-16-	
24A	A1002098	786834	1	 Circ.impr.display DSP49G2243 ver.C 256k		
24	A1003098	787082	1	 Boîtier display cpl HM Prestige Ver. D		
25	557A3007	786699	1	 Purgeur air auto.composite P32 V14	01-01-16-	
26	A1002104	786837	1	 Soupape secur.8bar 3/4 sanit	01-01-16-	
27	30540659	784813	1	Corps moussé HMTC grand volume V15	01-01-16-	
28a	507F4289	786034	1	 Epingle capteur sonde Prest.V14	01-01-16-	
28	557A6010	786722	1	 Capteur de pression Prest.V14	01-01-16-	
29	A1003132	787101	1	 Siphon DH50+bille+bague+joint	01-10-16-	
30	5576A071	786564	1	 Soupape secur.3bar 164kW 1/2->3/4	01-01-16-	
31	55426001	785274	1	 Robinet de vidange 1/2	01-01-16-	
32	39438046	784824	1	 Doigt de gant inox 1/2x950	01-01-16-	
33	5476G047	786519	1	 Sonde NTC 12K d5x18 1/8 +Molex conn.	01-01-16-	
34	A1002039	786808	1	Coque isolation pompe UPML	01-01-16-	
99	A1002668	787016	1	 Câble d'allumage HeatMAster Large		

Burner WM120









## Burner WM120

Code	Code GA	Quant.	Photo	Description	De --- A ---	Remarque
1	507F4344	786056	1	 Adapt.ventouse HMTC grand V15	01-01-16-	
2	537D6510	786357	1	 Flexible Masterflex D80 L550	01-01-16-	
3	537D6404	786286	1	 Coude 30° MF DN80 PP gris+joint	01-01-16-	
4	537DZ019	786448	1	 Rampe NIT NIT 98x372	01-01-16-	
5	A1005074	787431	1	 Isol.brûleur HM BO TC V15	16-08-18-	Prev: A1002431
6	507F4362	786067	1		01-01-16-	
7	51700144	785014	1	 Isol. sup. brûleur HMTC grand V15	01-01-16-	
8	557A9000	786728	1	 Clapet anti-retour prise d'air DN80	01-01-16-	
9	537D6512	786359	1		01-01-16-	
10	53437039	785089	1	 Prise de pression D:8,5 M5	01-01-16-	
11	49437026	784906	1	 Flexible silicone 5x9	01-01-16-	
12	537DC000	786426	1	 Pressostat gaz Prest.-HMTC	01-01-16-	
13	507F4349	786061	1		01-01-16-	
14	557a0092	786594	2	 O-ring 33x2 vanne gaz P120-399	01-01-16-	
15	537D4079	786159	1	 Vanne gaz VR4615VB1006 P120 V14	01-01-16-	
16	A1004642	787365	1			
17	557a0092	786594	1	 O-ring 33x2 vanne gaz P120-399	01-01-16-	
18	507F4350	786062	1		01-01-16-	
19	507F4360	786065	1	 Réduction 92->86 EPDM	01-01-16-	
20	557A0054	786583	1	 Joint bride ventil.Prest.	01-01-16-	



Burner WM120

Code	Code GA	Quant.	Photo	Description	De --- A ---	Remarque
21	507F4283	786028	1	 Kit regard flamme monobloc	01-01-16-	
22	557A0149	786623	1	 Joint regard flamme monobl(68x32x2 GPE)	01-01-16-	
23	10800313	784486	1	 Kit électrode HMTC grand + vis+joint	01-01-16-	
24	4372G009	785838	1	Raccord union 2 pièces M3/4' - F4/4'	01-01-16-	
25	A1002668	787016	1	 Câble d'allumage HeatMAster Large		