

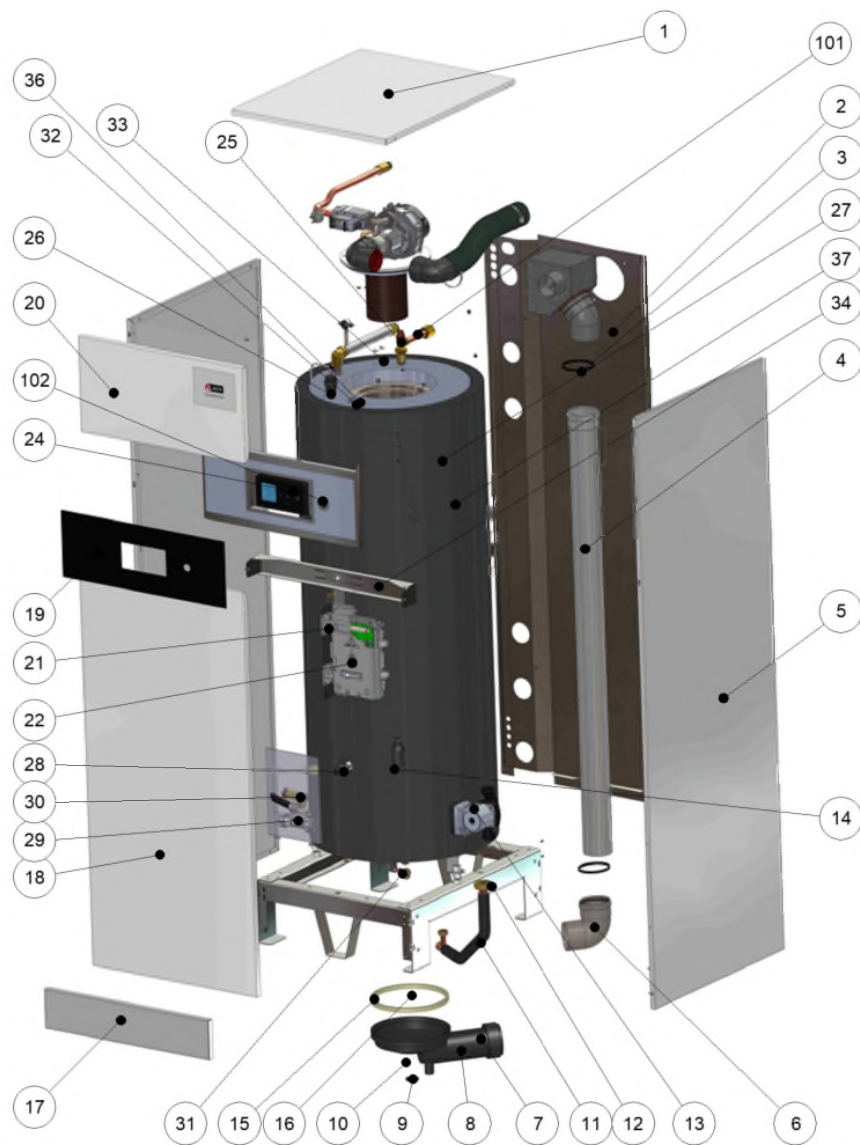











WaterMaster EVO 70-85-120

















WaterMaster EVO 70-85-120

	Code	Code GA	Quant.	Photo	Description	De --- A ---
1	564062	564062	0		Panneau supérieur Evo_BO	20-01-20-
2	564051	564051	0		Panneau arrière Evo_BO	20-01-20-
3	557A0106	786601	0		Joint à lèvre DN100 HR-EPDM noir	20-01-20-
4	497B6047	785925	0		Tube fumée PP DN100 L1580 HMTcgrand	20-01-20-
5	564056	564056	0		Panneau latéral G/D Evo_BO	20-01-20-
6	537D6438	786295	0		Coude 90° MF DN100 PP gris+joint	20-01-20-
7	10800262	784433	0		Bac cond. HMTc grand + joints	20-01-20-
8	5476g054	786524	1		Sonde NTC 12K d5x50 1/8' +conn. Molex	20-01-20-
9	557A0147	786622	0		Joint 24x14x2 novapress basic	20-01-20-
10	4779A011	785844	0		Ecrou 3/4 DIN431A inox HMTc	20-01-20-
11	507F4347	786059	0		Tube de recirculation HMTc grand V15	20-01-20-
12	55412047	785269	1		Joint 44-30x2 néoprène	20-01-20-
13	557A4035	786714	0		Circul. UPML 25 105 L180 G6/4	20-01-20-
14	5476g054	786524	1		Sonde NTC 12K d5x50 1/8' +conn. Molex	20-01-20-
15	557A0145	786621	0		Joint DI:250 bac.condens.HM85TC	20-01-20-
16	557A0144	786620	0		Joint 28-45x5 Viton bac condens.HMTc	20-01-20-
17	564045	564045	0		Base du panneau avant Evo_BO	20-01-20-
18	564047	564047	0		Façade inférieure Evo_BO	20-01-20-
19	564038	564038	0		Assemblage du panneau d'affichage Evo_BO	20-01-20-
20	564049	564049	0		Panneau avant supérieur Evo_SO	20-01-20-



WaterMaster EVO 70-85-120

		Code	Code GA	Quant.	Photo	Description	De --- A ---
21		564124	564124	0		BOÎTIER DE COMMANDE CHARNIÈRE ACVMAX V14 - Ignifuge	20-01-20-
22		564036	564036	0		Boîtier de commande HM Large TC V21	20-01-20-
22		564079	564079	0		CÂBLAGE 230V HMTC GRAND V21	20-01-20-
22		564081	564081	0		CÂBLAGE 24V HM-TC GRAND V21	20-01-20-
22		A1002113	786840	0		Câblage vanne HMTC medium V15	20-01-20-
22		A1003599	787222	0		Circ.impr.ACVMAX 230V (E) S4962S3038B	20-01-20-
24		564089	564089	0		Présentoir TOUCH noir HM/WM TC V21	20-01-20-
25		564143	564143	0		Soupape T&P 3/4 7Bar L 200	20-01-20-
25		A1002104	786837	0		Soupape secur.8bar 3/4 sanit	20-01-20-
26		557A3007	786699	0		Purgeur air auto.composite P32 V14	20-01-20-
27		564054	564054	0		Remplacement Corps + Isolation Evo_BO	20-01-20-
28		507F4289	786034	0		Epingle capteur sonde Prest.V14	20-01-20-
28		557A6010	786722	0		Capteur de pression Prest.V14	20-01-20-
29		A1003132	787101	0		Siphon DH50+bille+bague+joint	20-01-20-
30		5576A071	786564	0		Soupape secur.3bar 164kW 1/2->3/4	20-01-20-
31		55426001	785274	1		Robinet de vidange 1/2	20-01-20-
32		39438046	784824	1		Doigt de gant inox 1/2x950	20-01-20-
33		5476G047	786519	1		Sonde NTC 12K d5x18 1/8 +Molex conn.	20-01-20-
34		564058	564058	0		Assemblage du raidisseur latéral Evo_BO	20-01-20-
36		5476G003	786491	1		Sonde NTC 12K L:3200mm pour ballon	20-01-20-



WaterMaster EVO 70-85-120





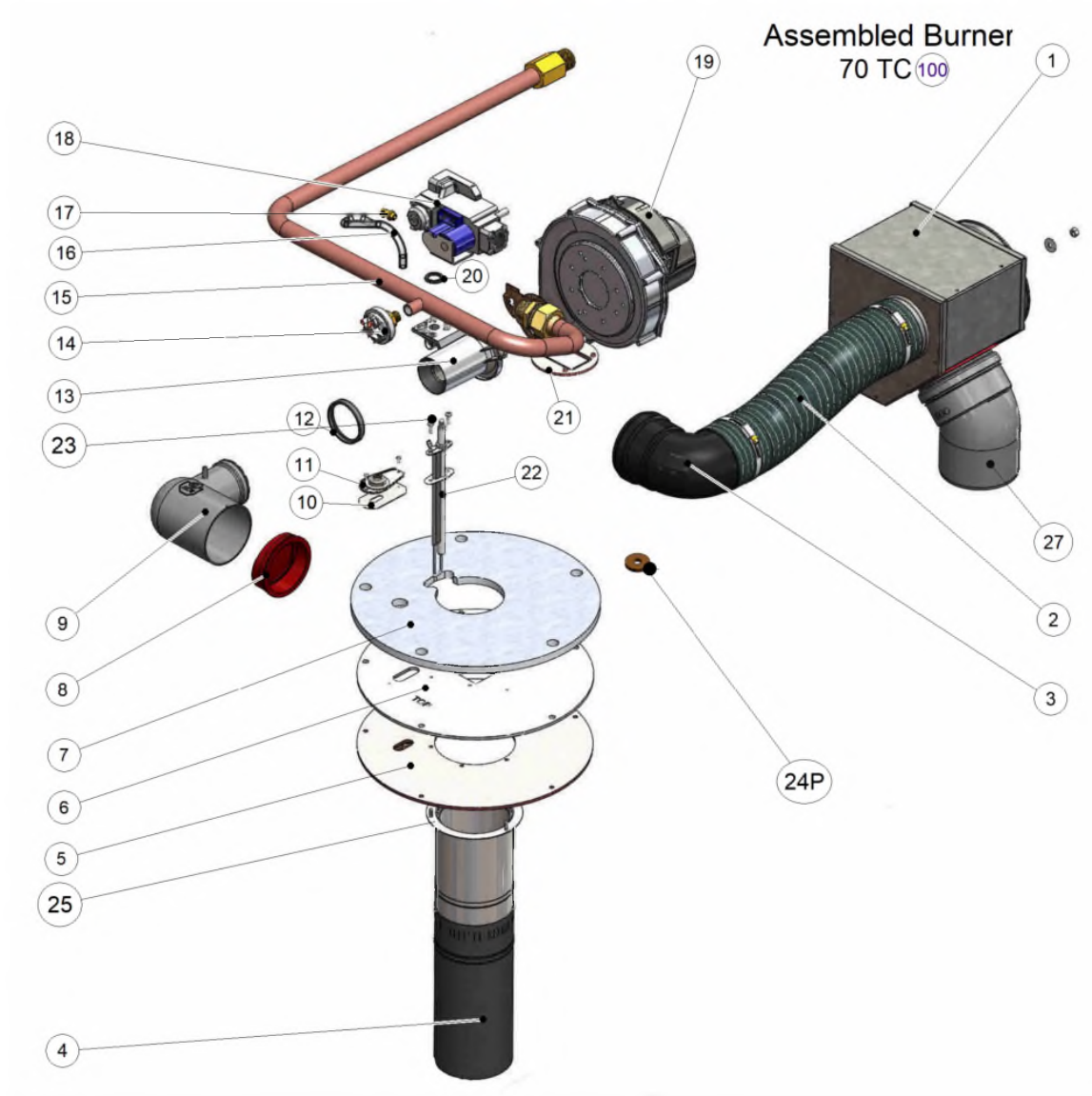













		Code	Code GA	Quant.	Photo	Description	De --- A ---
37		564129	564129	0		Kit Isolation HM TC BO V21	20-01-20-
99		564060	564060	0		Spar.Plug(filaire L1400)HM WM75-85-120 EVO	20-01-20-
99		564066	564066	0		Kit de matériel de montage chaudières Evo	20-01-20-
101		564086	564086	0		Tube en cuivre T&P BO	20-01-20-
102		564123	564123	0		Interrupteur général 2P HM-WM	20-01-20-
103		564040	564040	0		Tableau électrique HM-WM TC V21	20-01-20-

Burner HM EVO 70-85









Burner HM EVO 70-85

		Code	Code GA	Quant.	Photo	Description	De --- A ---
1		507F4344	786056	1		Adapt.ventouse HMTC grand V15	20-01-22-
2		537D6513	786360	1		Flexible Masterflex D80 L350	20-01-22-
3		537D6352	786269	1		Coude 90° D:80 PP air (noir)	20-01-22-
4		537DZ019	786448	1		Rampe NIT NIT 98x372	20-01-22-
5		A1005074	787431	1		Isol.brûleur HM BO TC V15	20-01-22-
6		507F4362	786067	1		Porte brûleur HMTC grand V15	20-01-22-
7		51700144	785014	1		Isol. sup. brûleur HMTC grand V15	20-01-22-
8		557A9000	786728	1		Clapet anti-retour prise d'air DN80	20-01-22-
9		537D6511	786358	1		Coude réduc. 80->50 HMTC V15	20-01-22-
10		557A0149	786623	1		Joint regard flamme monobl(68x32x2 GPE)	20-01-22-
11		507F4283	786028	1		Kit regard flamme monobloc	20-01-22-
12		557A0198	786651	1		Joint à lèvres DN50 santoprene gris	20-01-22-
13		537D4028	786129	1		Venturi VF051	20-01-22-
14		537DC000	786426	1		Pressostat gaz Prest.-HMTC	20-01-22-
15		507F4137	785972	1		Tube gaz HM70-85TC	20-01-22-
16		49437026	784906	1		Flexible silicone 5x9	20-01-22-
17		53437039	785089	1		Prise de pression D:8,5 M5	20-01-22-
18		537D4009	786121	1		Vanne gaz VK4115V1014	20-01-22-
19		537D3052	786112	1		Ventil.RG148-3633 P75 V14	20-01-22-
20		557A0098	786597	1		Joint vanne gaz-venturi	20-01-22-



Burner HM EVO 70-85

	Code	Code GA	Quant.	Photo	Description	De --- A ---
21	557A0054	786583	1		Joint bride ventil.Prest.	20-01-22-
22	564067	564067	1		Kit d'électrodes Evo_70-85-120kW	20-01-22-
23	564060	564060	1		Spar.Plug(filare L1400)HM WM75-85-120 EVO	20-01-22-
24	537D4037	786132	1		Opercule 6,8mm (VF051 G31)	20-01-22-
25	A1002432	786973	1		Joint rampe brûleur HMTc GV V15	20-01-22-
26	A1005074	787431	1		Isol.brûleur HM BO TC V15	20-01-22-
27	A1002002	786802	1		Coude 45° DN100 PP	20-01-22-
100	237D0189		1		brûleur HM 70TC V15	20-01-22-