



Thermor

Produits

Référence	Nom	Lettre
55832017	CHAUFFE-EAU HORIZONTAL CUMULUS GAMME 92	B

Paramètres

Référence	Puissance(W)	Tension (V)	Capacité/Largeur	Couleur	Lettre
55832017	2200	230/400	200		B



1507

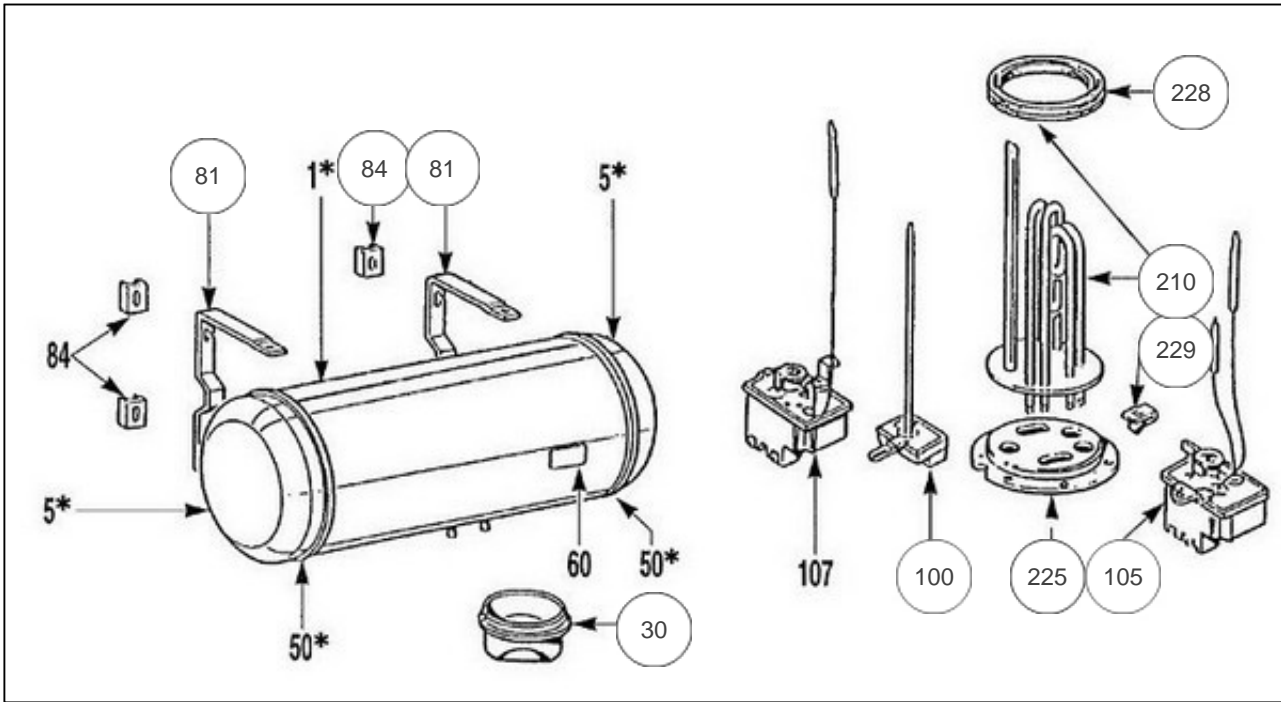



Références

Repère	Libellé	B
30	CAPOT ROND	022222
81	ETRIER HZ PEINT	022225
81	PATTE DE MAINTIEN ETRIER MURAL	022226
84	PATTE DE MAINTIEN ETRIER MURAL	022226
105	THERMOSTAT 2 BULBES 230/400V + PATTE	029477
210	ELEMENT BLINDE 2200W TRI + JOINT <i>2200 W 230/400 V</i>	060170
225	BRIDE EL.BL. CE HZ	060172
228	JOINT A LEVRE D.82MM	040155
229	ECROU CAGE	026020