



Thermor

Produits

Référence	Nom	Lettre
55813017	CHAUFFE-EAU MURAUX MIXTES A ECHANGEUR ANNULAIRE GAMME 91	A

Paramètres

Référence	Puissance(W)	Tension (V)	Capacité/Largeur	Couleur	Lettre
55813017	2400	230/400	200		A



1610

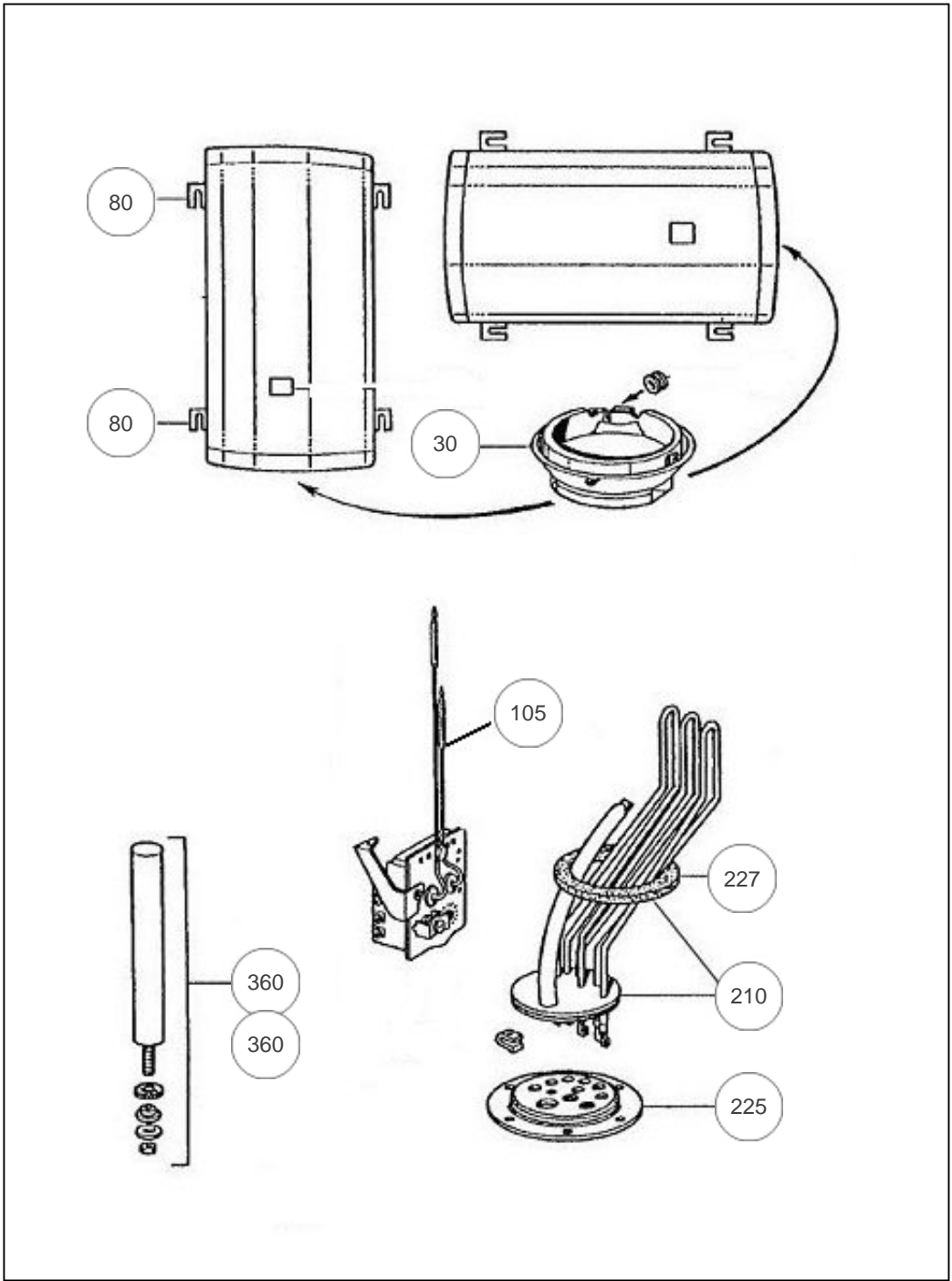



Références

Repère	Libellé	A
30	CAPOT ROND BLANC	022224
80	ETRIER D'ACCROCHAGE	022308
105	THERMOSTAT 2 BULBES	070089
210	ELEMENT BLINDE 2400W 230/400V	060196
225	BRIDE DE SERRAGE 6 TROUS	060197
227	JOINT A LEVRE D.82MM	099060
360	ANODE	040178