



Thermor ECS Collectif

Produits

Référence	Nom	Lettre
116835	CE 2000L STEAT 27KW ACC SM0 G5ANS	E

Nota: concernant les puissances supérieures à 5 KW, le thermostat devra commander un relais de puissance.

Paramètres

Référence	Puissance(W)	Tension (V)	Capacité/Largeur	Couleur	Lettre
116835	27 K	230/400	2000		E

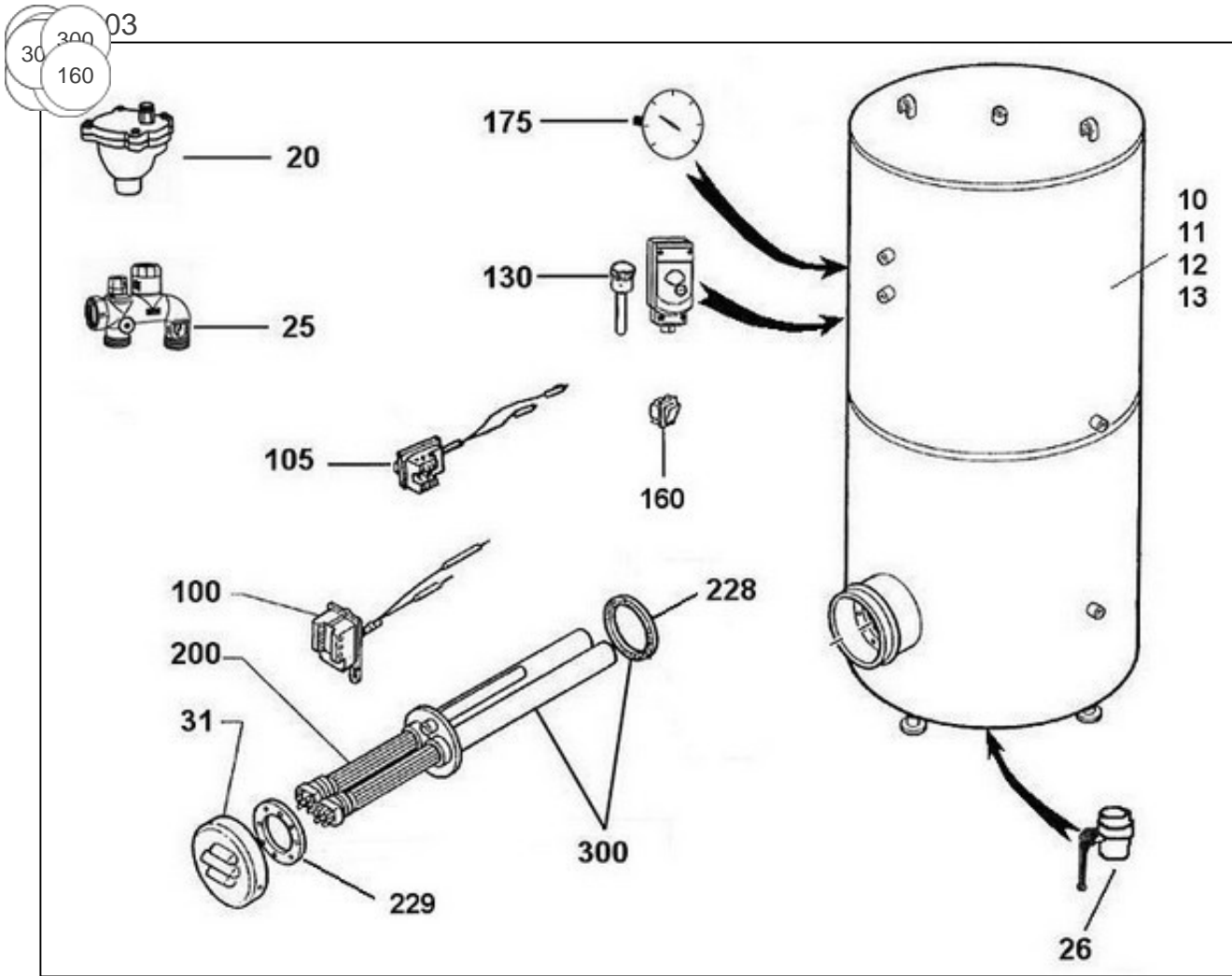



Références

Repère	Libellé	E
0	JOINT TROU D'HOMME BALLON DIA.440	070914
1	BORNIER ELECTRIQUE / 500 A 3000L	021092
2	ENSEMBLE FILERIE / RESISTANCE STEATITE	021090
10	JAQUETTE SOUPLE M1 2000L (NON PERCEE)	024011
	<i>->05.01</i>	
11	JAQUETTE SOUPLE M1 CE 2000L (PERCEE)	024041
	<i>05.01-></i>	
12	JAQUETTE SOUPLE MO 2000L (NON PERCEE)	024020
	<i>->05.01</i>	
13	JAQUETTE SOUPLE MO CE 2000L (PERCEE)	024027
	<i>05.01-></i>	
20	PURGEUR 26X34	029042
25	KIT COMPLET DOUBLE GROUPES 33X42	029028
26	VANNE 50/60	029043
31	CAPOT+COLLERETTE D.410	022294
105	THERMOSTAT BTS BIP. 270MM	070207
130	LIMITEUR ELECTRIQUE DE SECURITE	070177
175	THERMOMETRE CE INDUSTRIEL	070179
200	ELEMENT STEATITE D.50 6750W 3X230 L.1000	060320
	<i>H159495 -></i>	
200	ELEMENT STEATITE 6 KW	073783
	<i>G789396 -></i>	
228	JOINT PLAT D.316 (BRIDE D.370)	040298
	<i>G789396 -></i>	
228	JOINT PLAT 204X238X3 BRIDE D288	073741
	<i>H125091 -></i>	
229	COURONNE DIAM. EXT. 290 MM	040289
	<i>H159495 -></i>	
229	COURONNE DIAM. EXT. 370MM	040319
	<i>G789396 -></i>	
300	CORPS DE CHAUFFE 4T1010 4X6000W + JOINT	040280
	<i>H159495 -></i>	
300	CORPS DE CHAUFFE 5T1010 5X6000W + JOINT	040281
	<i>G789396 -></i>	