



Thermor

Produits

Référence	Nom	Lettre
273015	TH BLINDE HM 150L 2200M	B

Paramètres

Référence	Puissance(W)	Tension (V)	Capacité/Largeur	Couleur	Lettre
273015	2200	230	150		B



1520

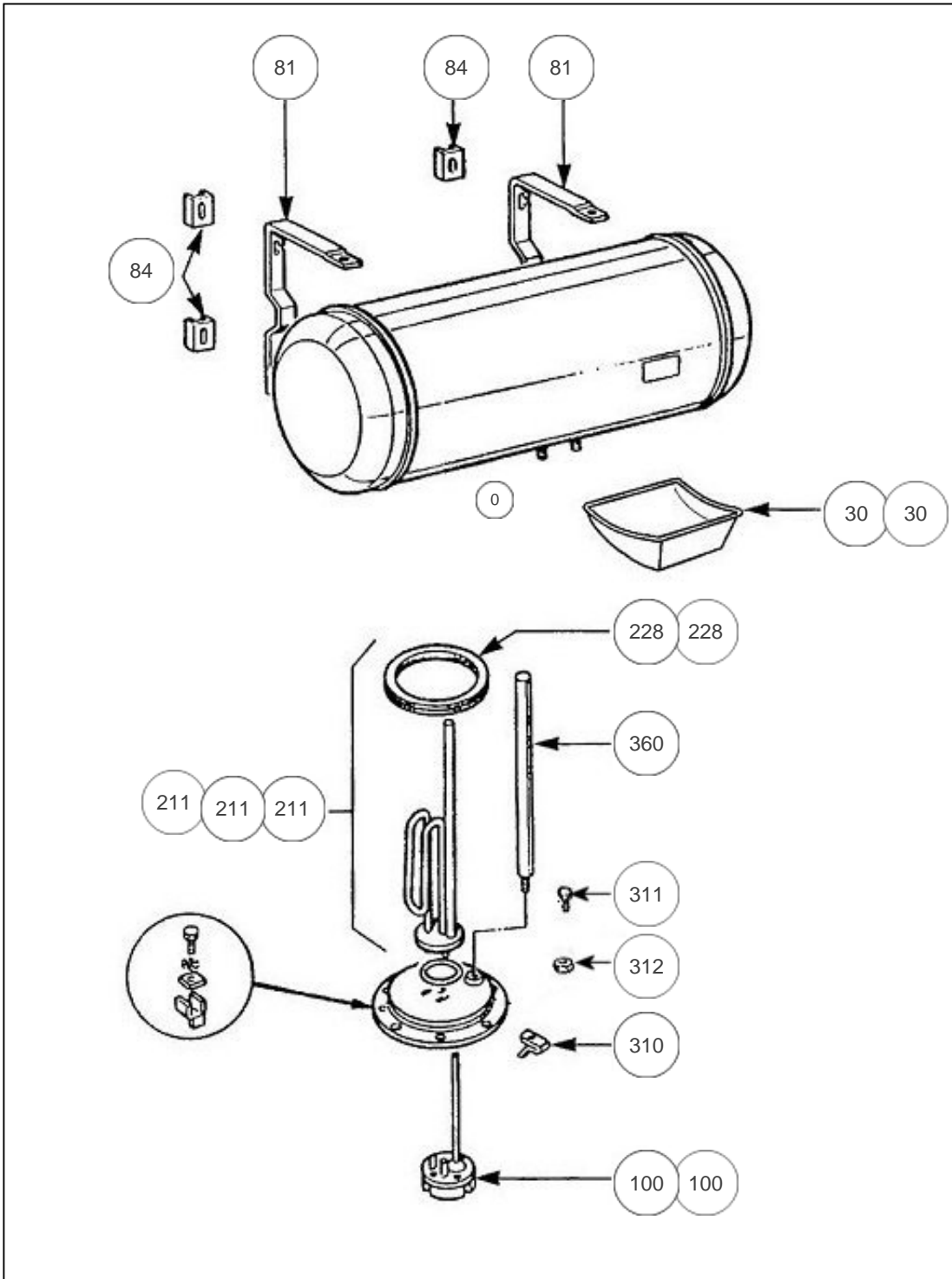



Références

Repère	Libellé	B
0	RACCORD DIELECTRIQUE 3/4 PLASTIQUE	026051
30	CAPOT LATERALE A CHARNIERES <i>avant/before 1408</i>	022331
30	CAPOT LATERAL SS/HZ NEUTRE <i>depuis/since 1408</i>	022589
81	ETRIER HZ PEINT	022225
84	PATTE DE MAINTIEN ETRIER MURAL	022226
100	THERMOSTAT EMBROCHABLE L270 MOL. BLEUE <i>Avant-before 1552</i>	070070
100	THERMOSTAT EMBROCHABLE L350 MOL. VERTE <i>Depuis-since 1552</i>	029577
211	ENS. EL.BLINDE 2200W 230V + JOINT <i>avant/before 1408</i>	060269
211	RESISTANCE BLINDEE 2200W 230V +JT +ANODE <i>1408 -> 1552</i>	099005
211	ENS. BLINDE 2200W 230V L350 + JT + ANODE <i>Depuis-since 1552</i>	030238
228	JOINT A LEVRE D.82MM <i>avant/before 1408</i>	040155
228	JOINT A LEVRE D.82MM <i>depuis/since 1408</i>	099060
310	ECROU CAGE <i>avant/before 1408</i>	026020
311	VIS ANTI-ROTATION HM8 X1 <i>depuis/since 1408</i>	026063
312	ECROU HM8 X1 <i>depuis/since 1408</i>	026064
360	ANODE MAGNESIUM D26 L322	040166