



Thermor

Produits

Référence	Nom	Lettre
45712053	CHAUFFE-EAU MURAUX H.P. CARRE - CURVILIGNE A.C.I. GAMME 96	C

Paramètres

Référence	Puissance(W)	Tension (V)	Capacité/Largeur	Couleur	Lettre
45712053	1800	230/400	150		C



1343

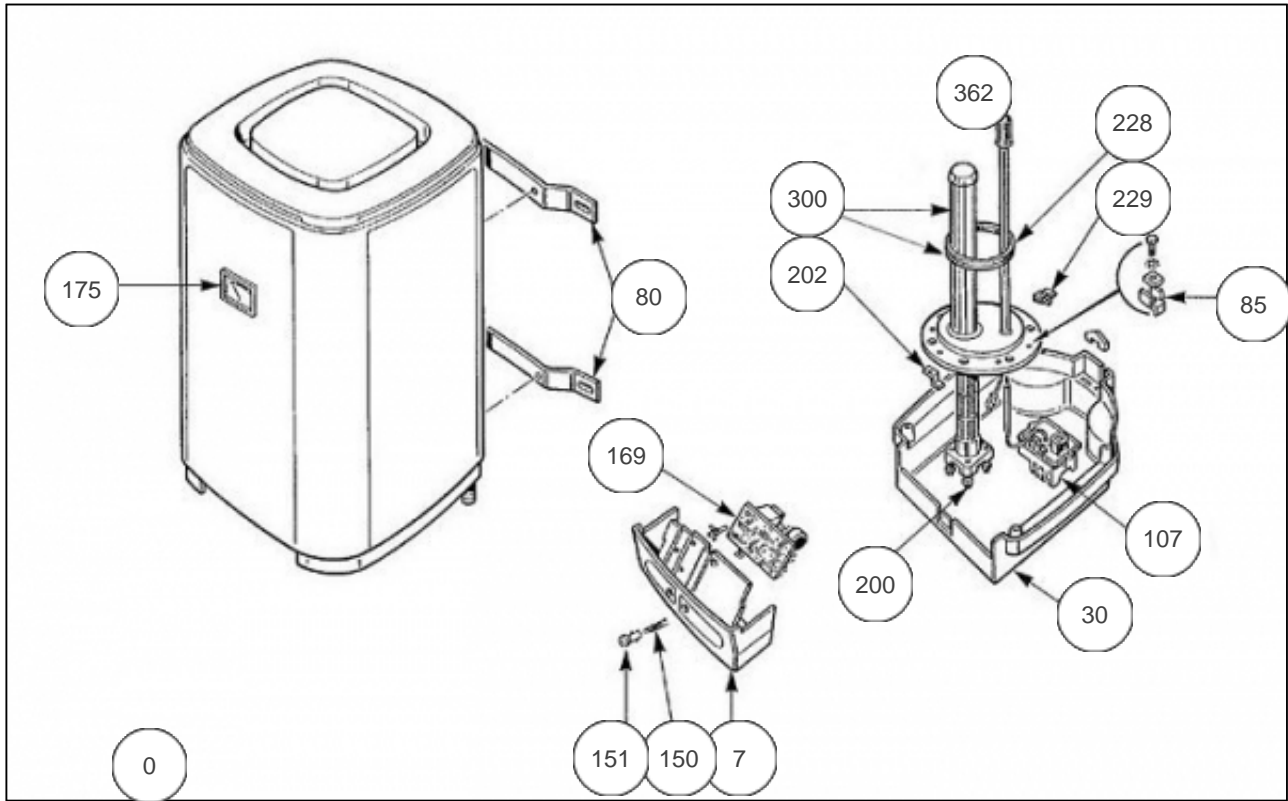



Références

Repère	Libellé	C
0	RACCORD DIELECTRIQUE 3/4 PLASTIQUE	026051
7	TABLEAU DE BORD	022267
30	CAPOT DE PROTECTION	022253
80	ETRIER DE FIXATION	022254
85	ENSEMBLE BORNE DE TERRE	026044
107	THERMOSTAT TRI 1 BULBE	070131
150	VOYANT	020082
151	LENTILLE ROUGE	020081
169	PLATINE ELECTRONIQUE ACI TC	040239
175	THERMOMETRE CE C. CURV	070117
200	RESISTANCE STEATITE 1800W 230/400V	060175
202	SUPPORT ELEMENT	026041
228	JOINT A LEVRE D.112MM	040158
229	ECROU CAGE	026020
300	CORPS DE CHAUFFE ACI D.195 + JOINT	040227
362	ANODE ACI + BOUCHON	040374