



Thermor

Produits

Référence	Nom	Lettre
526793	AEROLIA DUO 11 TRI	B

Codes UE associés : 200197 (11KW Mono), 300175 (14KW Mono), 200176 (11KW TRI), 200177 (14KW TRI), 200178 (16KW TRI)



Ballon

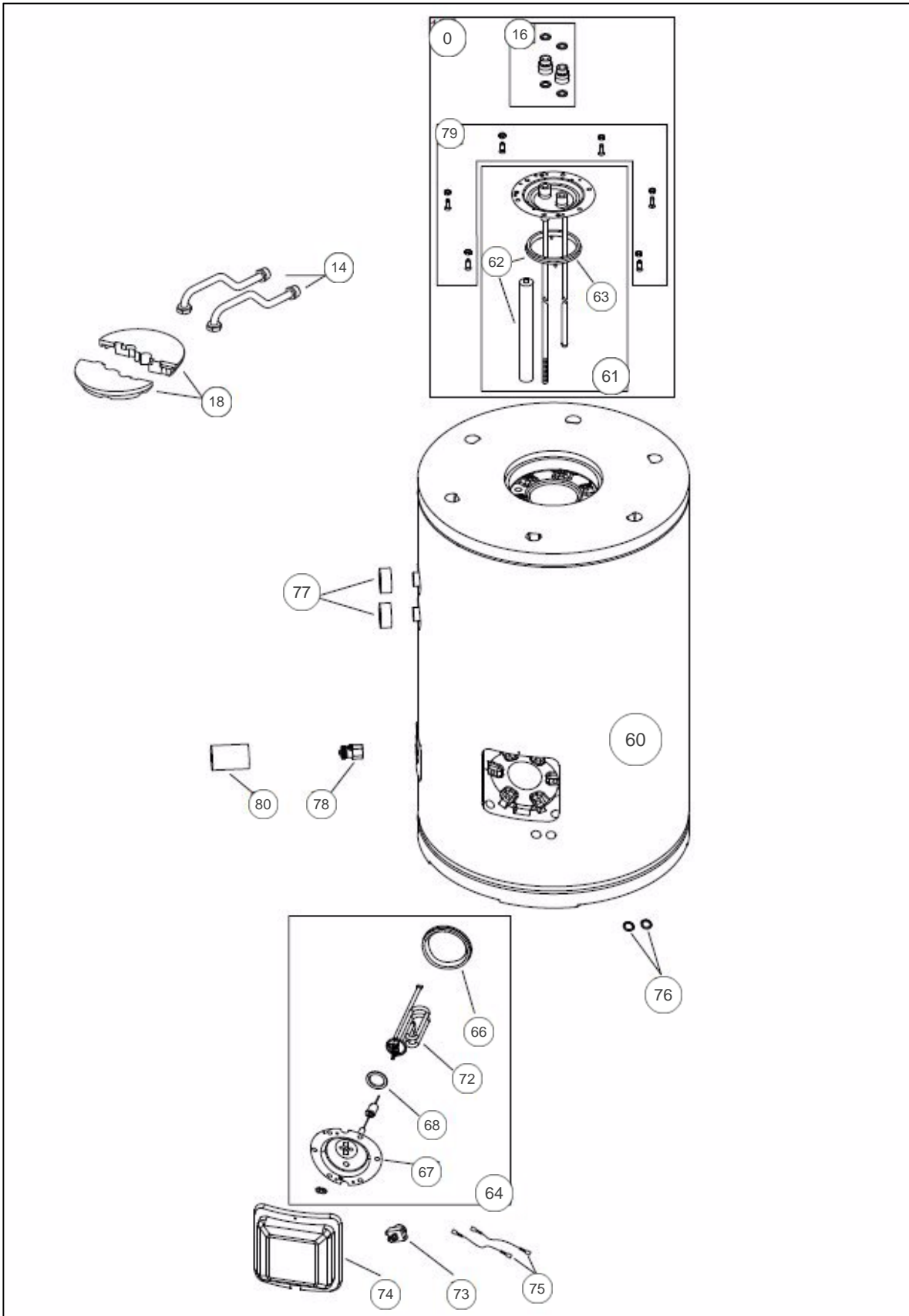



Références

Repère	Libellé	B
0	KIT SAV TRAPPE 190L	943161
14	TUYAUTERIE SANITAIRE	184197
16	KIT DE 2 RACCORDS DIELECTRIQUES	943151
18	ISOLANT TRAPPE BALLON	111531
60	BALLON	904548
61	TRAPPE SUPERIEURE AVEC ANODE	132760
62	ANODE +JOINT	100403
63	JOINT DE BRIDE	142487
64	TRAPPE DE VISITE LATERALE PR BALLON 190L	132756
66	JOINT DE TRAPPE BALLON	142477
67	BRIDE LATERALE PR ENSEMBLE FOURREAU	105188
68	JOINT DE RESISTANCE	142494
72	RESISTANCE BLINDEE	168013
73	THERMOSTAT SECURITE 90 +/- 5 DEGRES C	179072
74	CAPOT + ISOLANT BALLON	912170
75	FAISCEAU APPOINT THERMOSTAT	133169
76	PASSE FIL MEMBRANE PERFOREE DIAM5 DG16/5	157337
77	ISOLANT PIQUAGE BALLON	141163
78	ROBINET VIDANGE 3/4 POUCE MALE	166711
79	VIS ANTIROTATION (X 6) + ECROU	190043
80	ISOLANT ROBINET	141164



Cablage

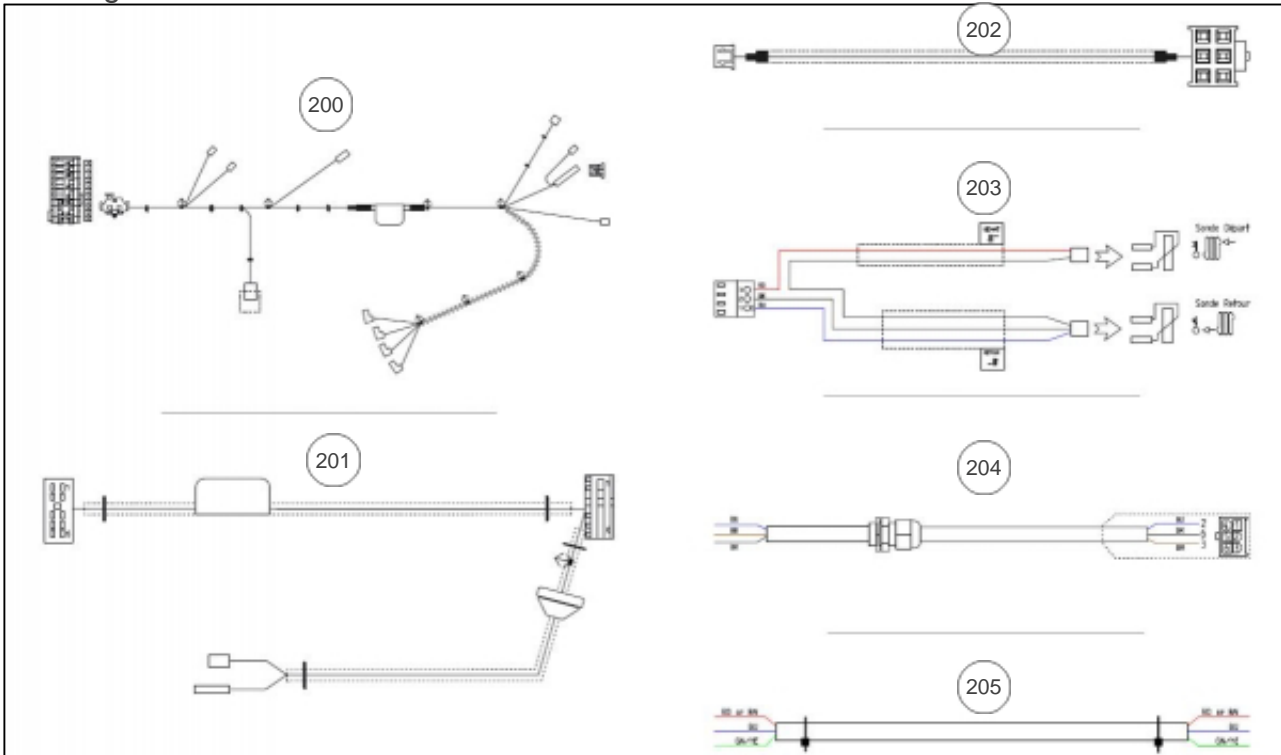



Références

Repère	Libellé	B
200	FAISCEAU ALIM PAC DUO	133246
201	FAISCEAU ALIMENTATION IHM ET ACI	109651
202	FAISCEAU INTERFACE	109672
203	FAISCEAU SONDE DEPART ET RETOUR	109650
204	FAISCEAU ALIM V3V COUDE	133247
205	CABLE APPOINT ECS	109746

PRENDRE 909243



Habillage

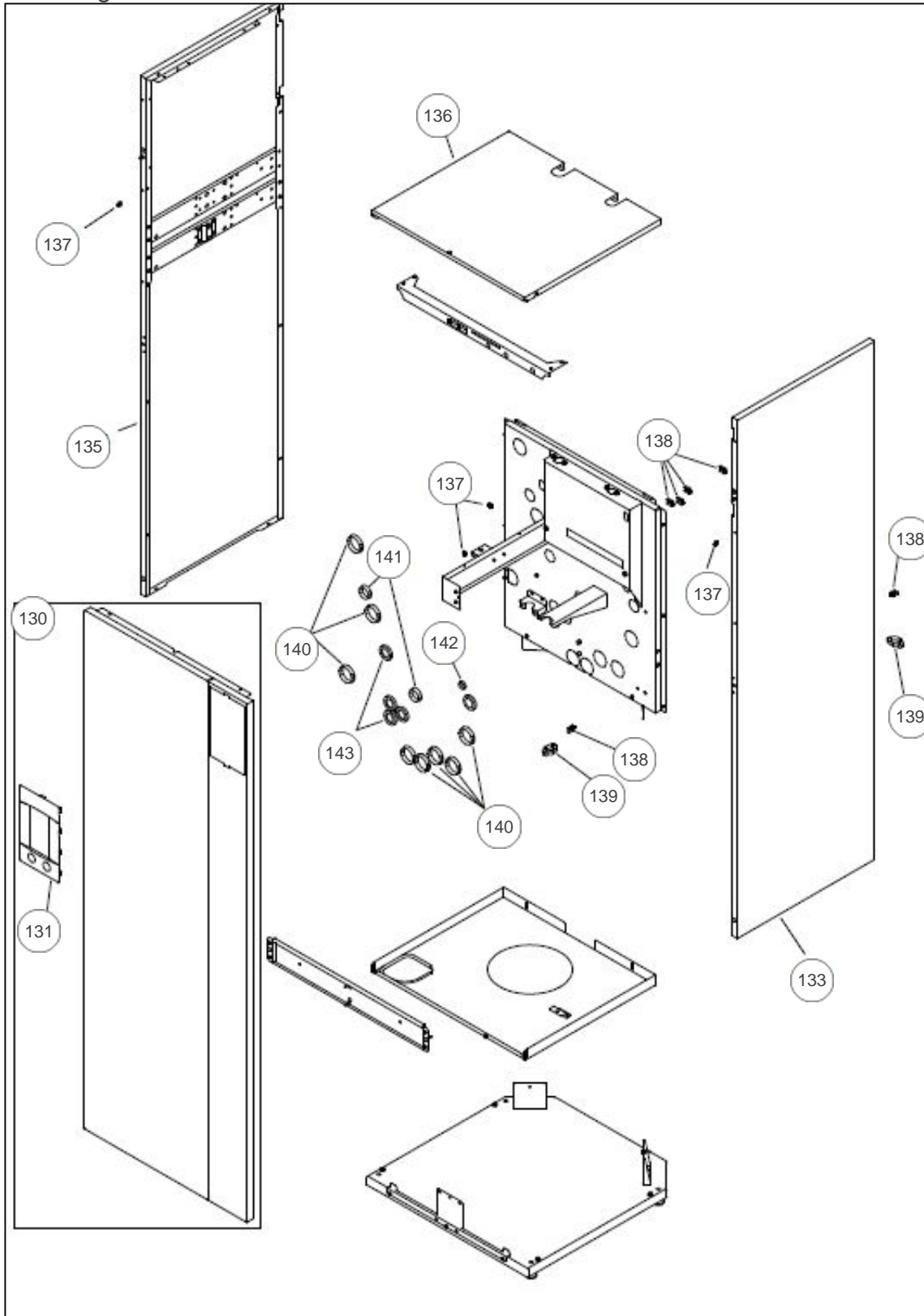



Références

Repère	Libellé	B
130	FACADE	937444
131	ENJOLIVEUR	123390
133	COTE DROIT	915055
135	COTE GAUCHE	915054
136	COUVERCLE	252606
137	ATTACHE CABLE	100632
138	ATTACHE CABLE	100634
139	AGRAFE	100109
140	PASSE FILS	157326
141	PASSE-FIL 9722510	157312
142	PASSE FIL	157311
143	PASSE-FILS DG-TPE29	157306



Tuyauterie

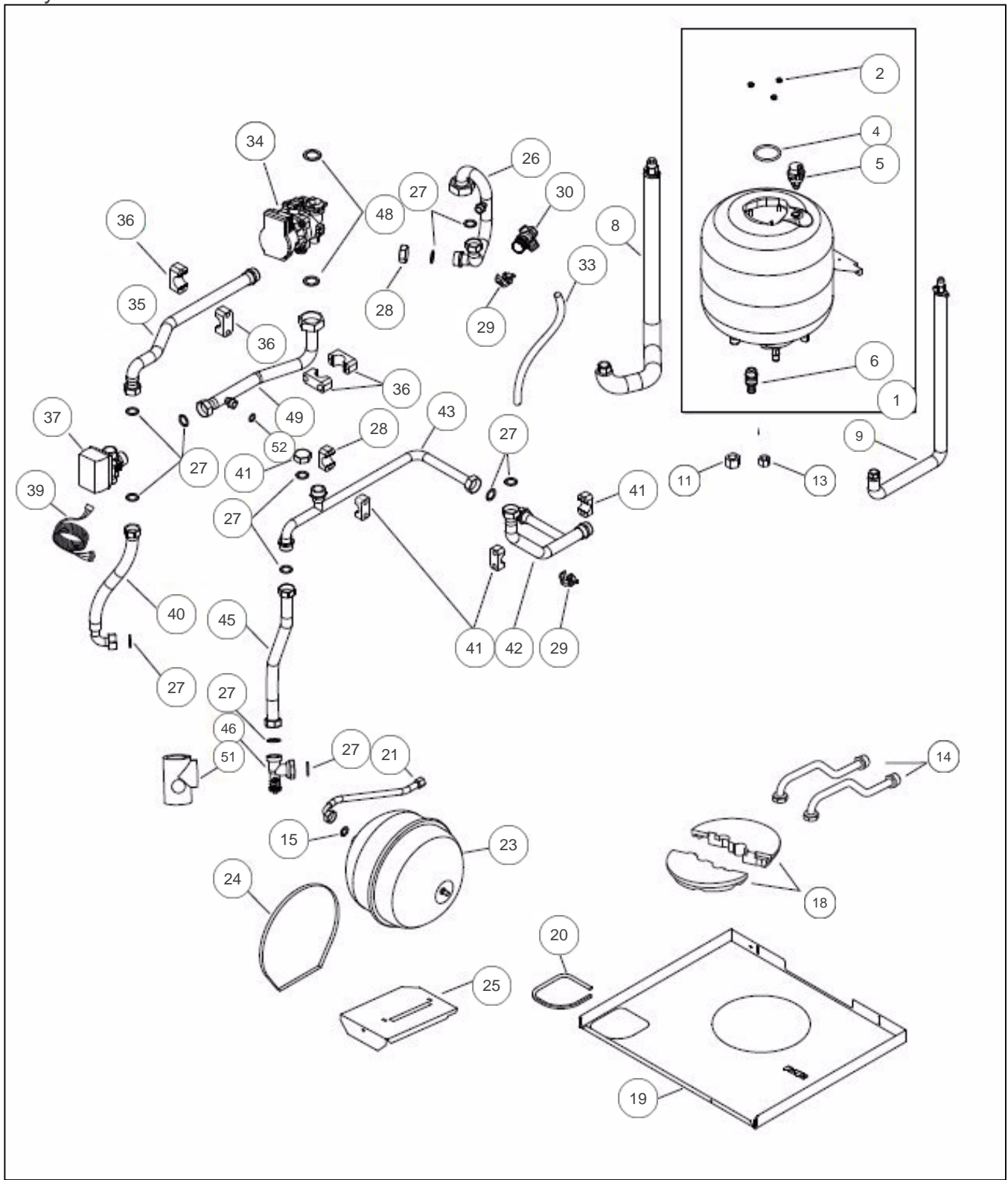



Références

Repère	Libellé	B
1	CORPS DE CHAUFFE	914003
2	ECROU H M6	122435
4	JOINT	142739
5	PURGEUR + VI R88/13	159410
6	VANNE DE DECHARGE + BOUCHON	167711
8	TUYAU FRIGO 5/8"	184082
9	TUYAU FRIGO 3/8"	184081
11	ECROU FLARE 5/8	122673
13	ECROU FLARE 3/8	122671
14	TUYAUTERIE SANITAIRE	184197
15	JOINT20X27CNA EAU/P	142442
18	ISOLANT TRAPPE BALLON	111531
19	PLATEAU TECHNIQUE	956104
20	JOINT PROFIL NOIR 1M	159200
21	TUYAUTERIE FLEXIBLE DE VASE	183288
23	VASE EXPANSION CHAUFF 12L CYLINDRIQUE	188265
24	COLLIER DE SERRAGE	110626
25	SUPPORT VASE	217322
26	TUYAU RETOUR ECHANGEUR	184083
27	JOINT	142735
28	BOUCHON FEMELLE LAITON	104863
29	SONDE ET FAISCEAU D28	909206
30	SOUPAPE CE 3 BARS 1/2P FEMELLE	174443
33	FLEXIBLE	132267
34	CIRCULATEUR + ISOLANT	909907
35	TUYAUTERIE RETOUR	184126
36	COLLIER	110618
37	MOTEUR + VANNE	988124
39	FAISCEAU MOTEUR	109444
	<i>PRENDRE 133247</i>	
40	FLEXIBLE RETOUR BALLON	132243
41	COLLIER 9522101	110611
42	TUYAU DEPART	184086
43	TUYAUTERIE ENTREE BALLON	184125
45	FLEXIBLE DEPART BALLON	132264



Références

Repère	Libellé	B
46	TE LAITON F1POUCE M1POUCE AVEC VIDANGE	177561
48	JOINT EP.2 40X49	142734
49	TUYAUTERIE VANNE ECS - CIRCULATEUR	184124
51	ISOLANT TE	141165
52	JOINT15X21CNA EAU/P	142723



Tableau de Bord

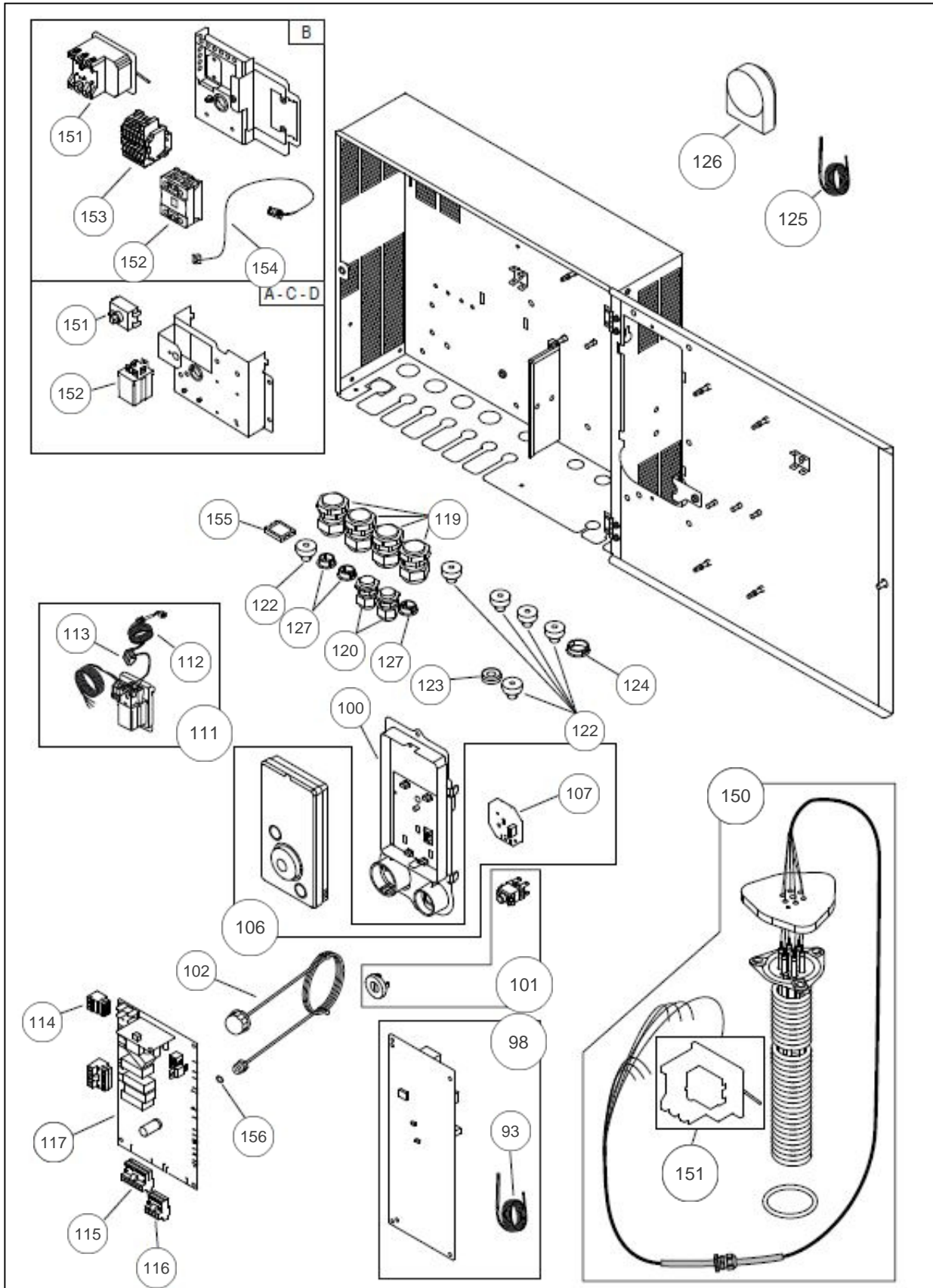



Références

Repère	Libellé	B
93	SONDE ECHANGEUR PAC	198762
98	CARTE INTERFACE	965438
100	SUPPORT AFFICHEUR IHM N4	175002
101	BOUTON MARCHE ARRET	943187
102	MANOMETRE D27 0/4 BAR	149978
106	INTERFACE UTILISATEUR	139121
107	CARTE ELECTRONIQUE	197123
111	KIT ALIMENTATION APPOINT ECS	909243
112	FAISCEAU ALIM V3V COUDE	133247
113	CONNECTEUR	110866
114	CONNECTEUR 3 PLOTS	110862
115	CONNECTEUR 6PLOTS X150	110867
116	CONNECTEUR 4 PLOTS	110868
117	CARTE REG.PROGR. AEROLIA 11/14/16 TRI	965488
119	PRESSE ETOUPE PERFECT PG16	161020
120	PRESSE ETOUPE PA9	161016
122	PASSE FILS GRIS	157320
123	PASSE-FILS DG-TPE 9	157305
124	PASSE FIL	157311
125	SONDE SANITAIRE	198792
126	SONDE EXT.QAC 34/101	198747
127	BOUCHON D15.95	104725
150	APPOINT ELECTRIQUE TRIPHASE 9KW	943150
151	THERMOSTAT SECU TRI 80°C	178992
152	RELAIS STATIQUE	165628
153	BORNIER TRIPHASE	106483
154	FAISCEAU MODUL APPOINT TRI	109737
155	PASSE FIL CARRE	157318
156	JOINT DISCONNECTEUR	142912