



Thermor

Produits

Référence	Nom	Lettre
284007	BAL. ECHANG. MULTIPOSITION 200L	A

Paramètres

Référence	Puissance(W)	Tension (V)	Capacité/Largeur	Couleur	Lettre
284007			200		A



1909

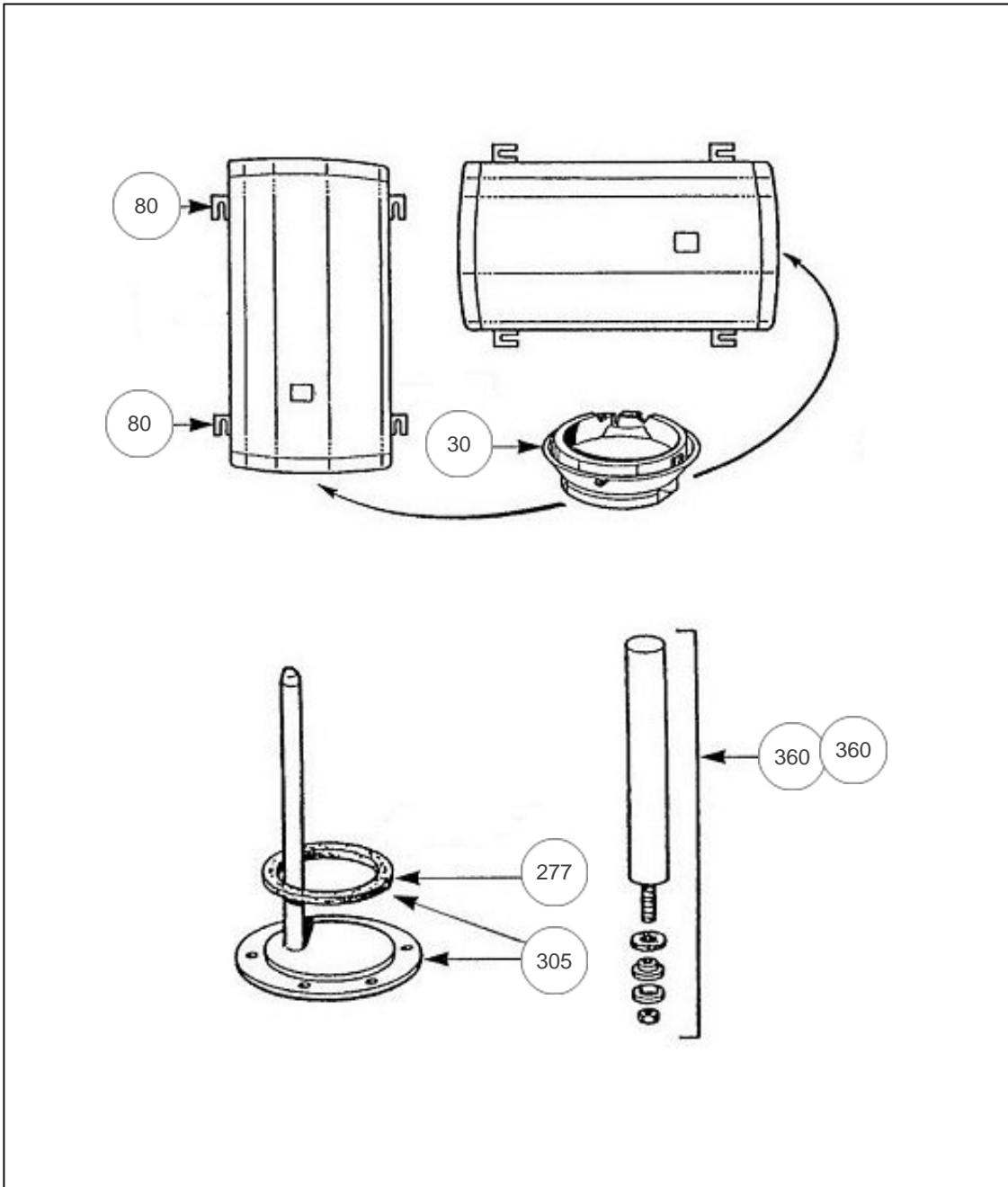



Références

Repère	Libellé	A
30	CAPOT ROND BLANC	022224
80	ETRIER D'ACCROCHAGE	022308
277	JOINT A LEVRE D.82MM	099060
305	PLAQUE DE FERMETURE + JOINT	040202
360	ANODE <i>200 L</i>	040177
360	ANODE <i>150 L</i>	040178