



Thermor

Produits

Référence	Nom	Lettre
253010	TH BLINDE HM 075L 1600M	A

Paramètres

Référence	Puissance(W)	Tension (V)	Capacité/Largeur	Couleur	Lettre
253010	1600	230	75		A



1520

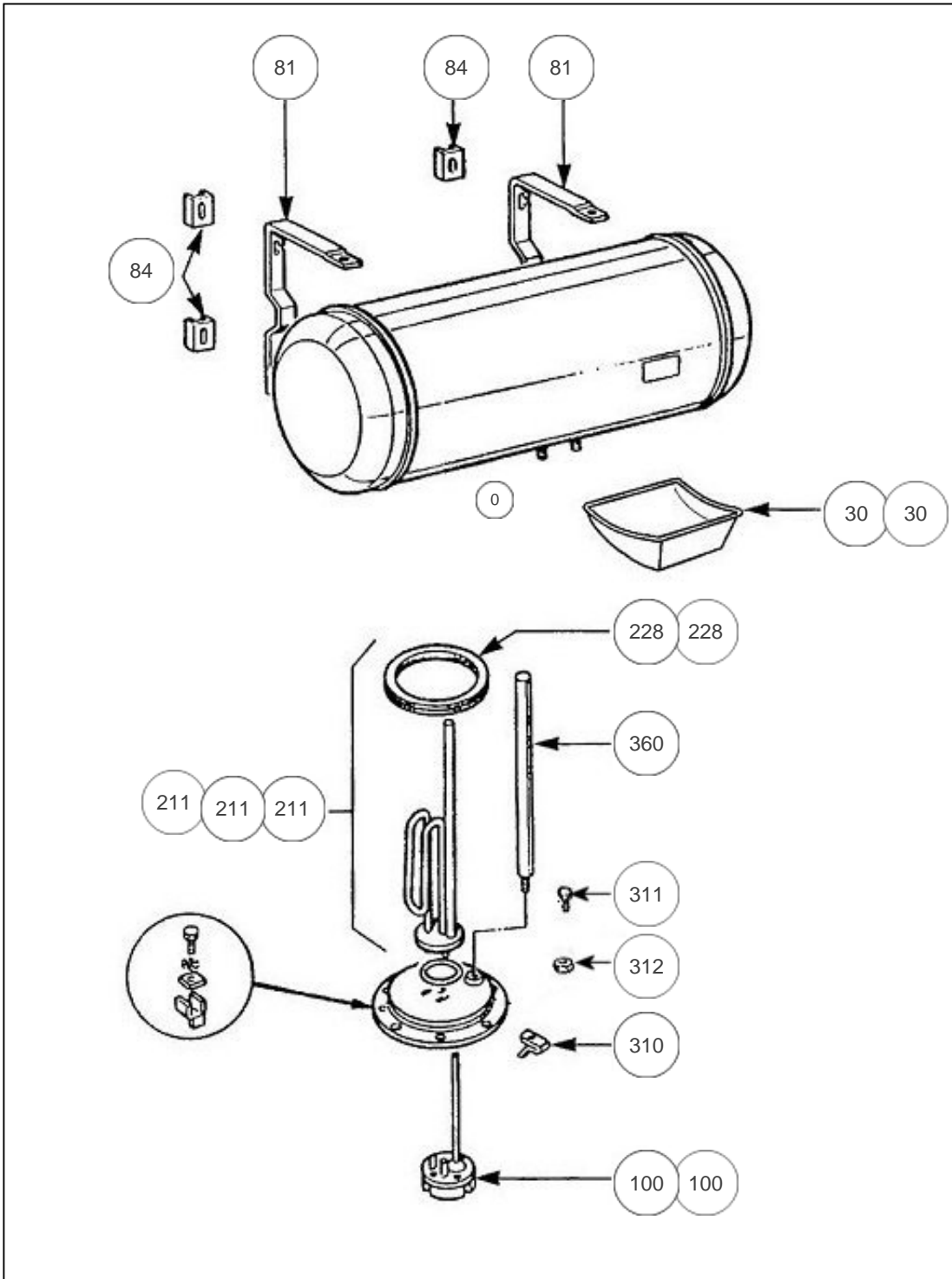



Références

Repère	Libellé	A
0	RACCORD DIELECTRIQUE 3/4 PLASTIQUE	026051
30	CAPOT LATERALE A CHARNIERES <i>avant/before 1408</i>	022331
30	CAPOT LATERAL SS/HZ NEUTRE <i>depuis/since 1408</i>	022589
81	ETRIER HZ PEINT	022225
84	PATTE DE MAINTIEN ETRIER MURAL	022226
100	THERMOSTAT EMBROCHABLE L270 MOL. BLEUE	070070
211	RESISTANCE BLINDEE 1600W 230V +JT +ANODE <i>avant/before 1408</i>	060268
211	RESISTANCE BLINDEE 1650W 230V +JT +ANODE <i>depuis/since 1408</i>	099004
228	JOINT A LEVRE D.82MM <i>avant/before 1408</i>	040155
228	JOINT A LEVRE D.82MM <i>depuis/since 1408</i>	099060
310	ECROU CAGE <i>avant/before 1408</i>	026020
311	VIS ANTI-ROTATION HM8 X1 <i>depuis/since 1408</i>	026063
312	ECROU HM8 X1 <i>depuis/since 1408</i>	026064
360	ANODE MAGNESIUM D26 L186	040208