



Thermor

Produits

Référence	Nom	Lettre
65822005	CHAUFFE EAU SUR SOCLE NORMAUX GAMME 86	A

Paramètres

Référence	Puissance(W)	Tension (V)	Capacité/Largeur	Couleur	Lettre
65822005	2400	220/380	200		A



1407

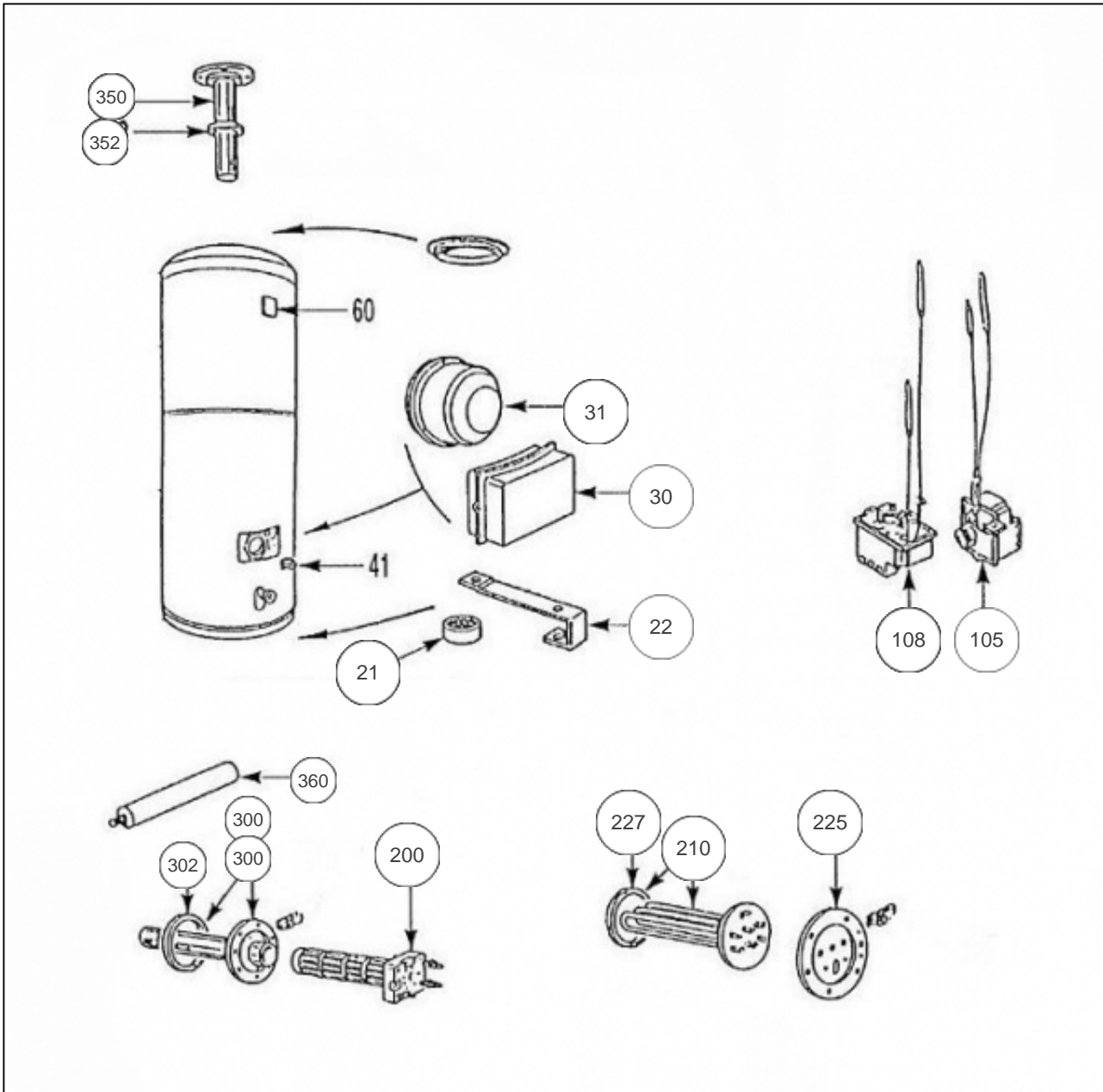



Références

Repère	Libellé	A
21	PATIN PLAST. CE G86 S/S	026027
31	CAPOT ROND	022222
108	THERMOSTAT 2 BULBES 230/400V + PATTE	029477
200	RESISTANCE STEATITE 2200W TC <i>2400 W 230/400 V</i>	099022
300	CORPS DE CHAUFFE + JOINT <i>91.21-></i>	040182
300	CORPS DE CHAUFFE + JOINT <i>->91.20</i>	040145
302	JOINT A LEVRE D.82MM	040155
350	BRIDE ANODE	040131
352	JOINT BRIDE ANODE	040129
360	ANODE MAGNESIUM D33 L315/286 <i>91.21-></i>	040168