



*Pièces de rechange*

20/03/2024

<i>Produit</i>	892299 - STYX BRDN 200 PROTECH
<i>Modèle</i>	BRDN
<i>Marque</i>	STYX
<i>Date</i>	09/07/2013

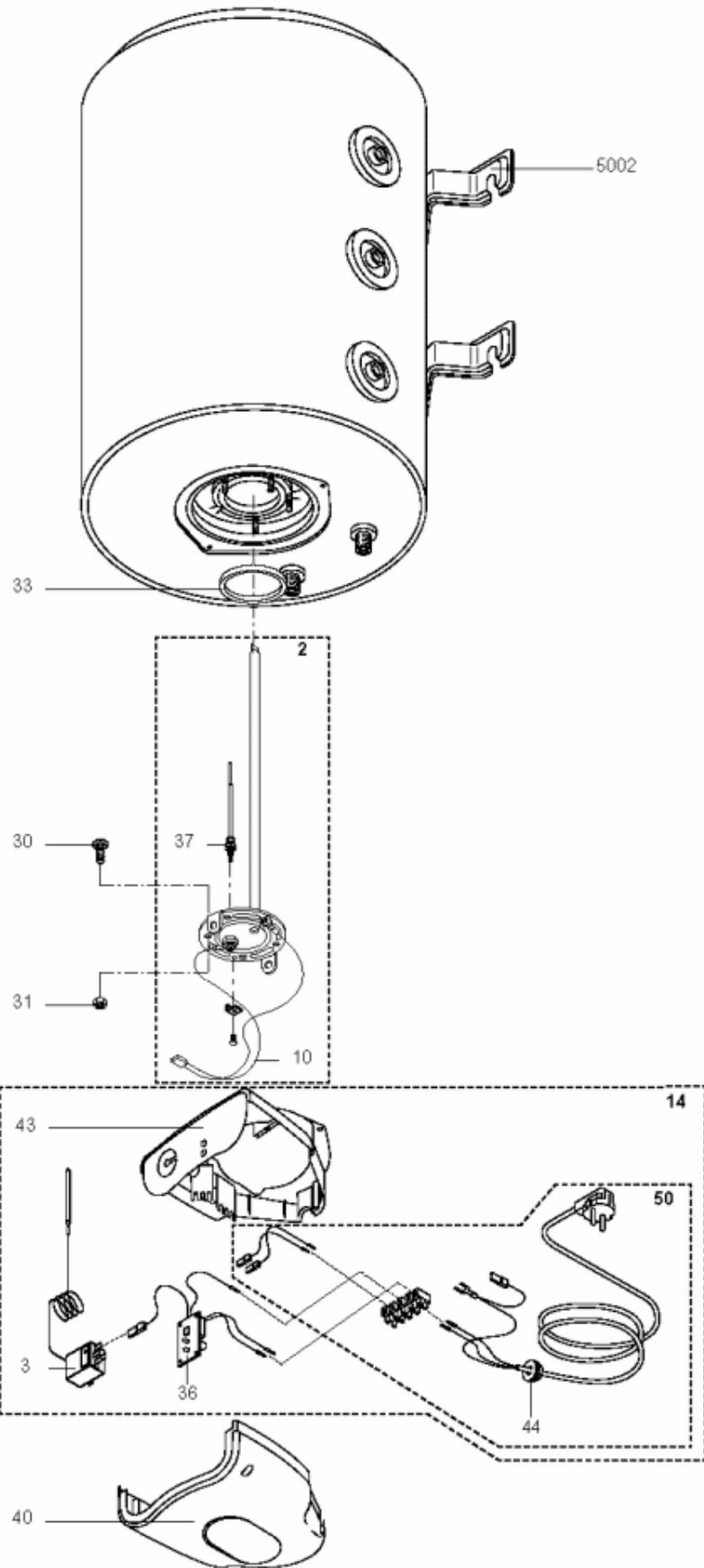

Table		BRDN-BRGN							
Rep.	Référence	ALIAS	Désignation	Remplacé par	Date début	Date fin	Multiple de vente	Tarif Public Unitaire HT	
2	61314457		CONTRE BRIDE		10/07		1	€ 91,88	
2	65101338		EMBASE 5 TROUS COMPLETE ET BOUGIE			10/07	1	€ 103,49	
3	921058		THERMOSTAT A BULBE				1	€ 50,45	
10	61312173		CABLAGE (BOUGIE E MASSE - C.I.)		10/07	02/08	1	€ 11,08	
10	340409		CABLAGE ANODE PROTECH			10/07	1	€ 18,05	
10	60001108-01		CABLAGE ELECTRODE - C.I.		02/08		1	€ 11,61	
14	925352		BOITIER ELECTRIQUE				1	€ 208,50	
30	60000681		VIS DE FIXATION EMBASE M 8-14 (6 ST.)	61005231	10/07		10	€ 1,73	
30	918001		VIS M8X25			10/07	1	€ 1,86	
31	918004		ECROU FIXATION EMBASE M8				1	€ 4,18	
33	924001		JOINT BRIDE Ø 75 - 5 TROUS	60003308		10/07	1	€ 10,21	
33	60071829		JOINT BRIDE D:121.3-105-7.1		10/07		1	€ 3,78	
36	925348-01		CIRCUIT IMPRIME ANODE / ELECTR.				1	€ 124,34	
37	340406		ANODE PROTECH INT LG95				1	€ 57,25	
40	926299		COUVERCLE BOITIER	60000956			1	€ 16,87	
43	60000711		FOND DE BOITIER				1	€ 36,99	
44	65102744		PASSE CABLE		10/05		1	€ 4,71	
44	926283		PASSE CABLE			10/05	1	€ 6,98	
50	935344		KIT ELECTRIQUE				1	€ 34,05	
5002	912006		PATTE MURALE D:470-505-560-570				1	€ 23,26	