



Pièces de rechange

14/03/2024

<i>Produit</i>	3080327 - PERFO 1500 M0
<i>Modèle</i>	> 300L STEATITE & BLINDEE
<i>Marque</i>	STYX
<i>Date</i>	20/01/2016

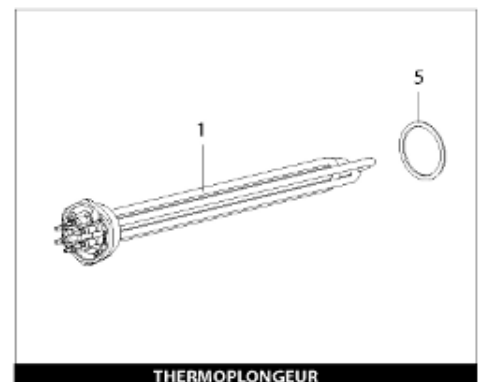
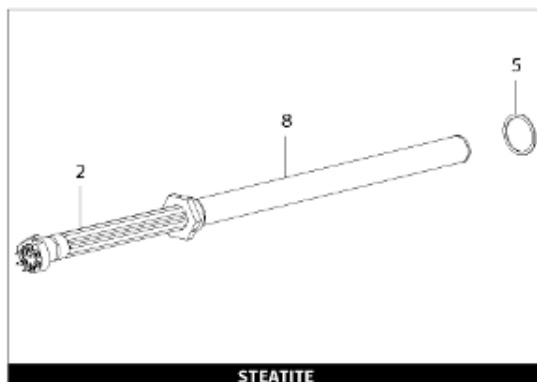
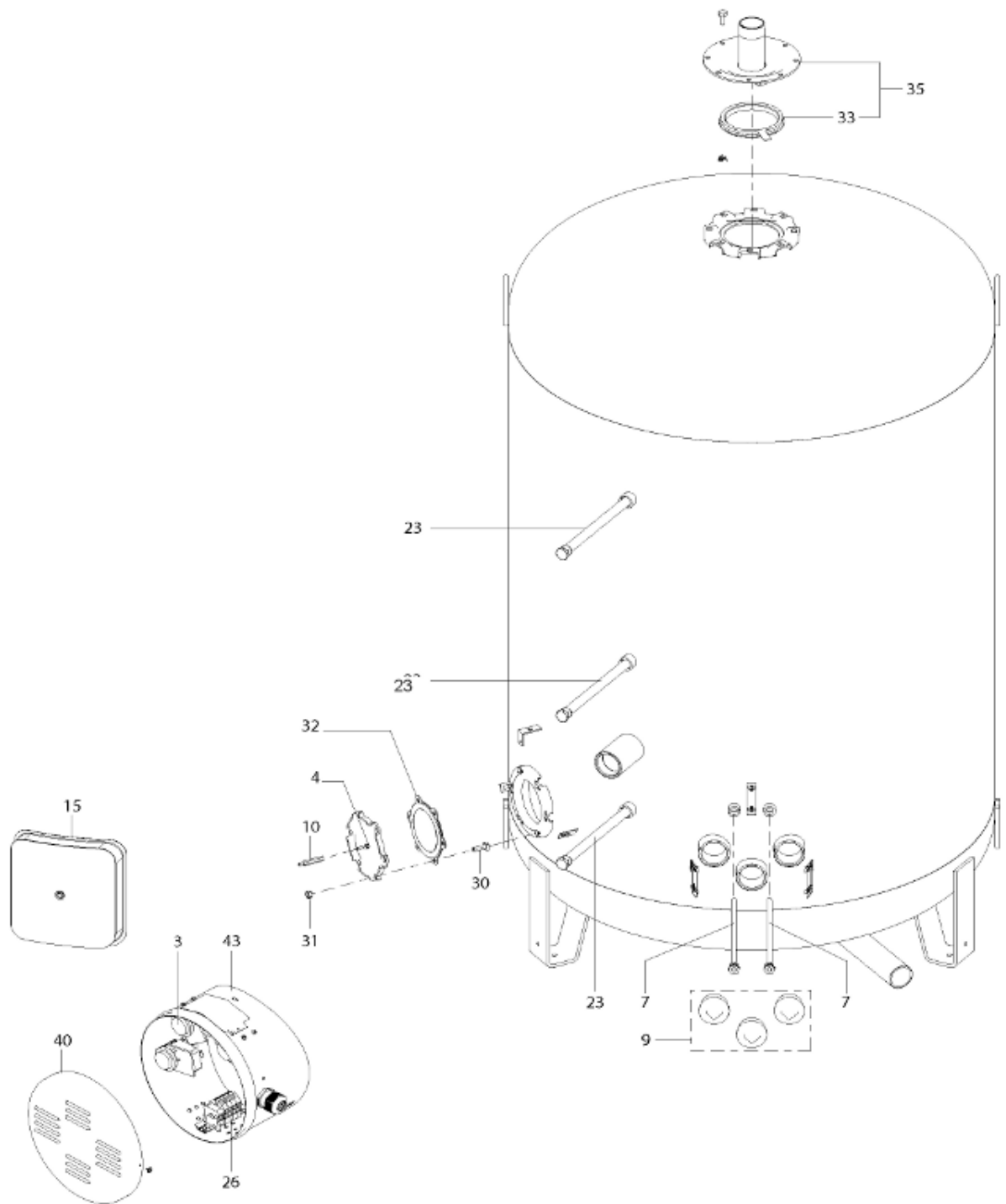

Table		PERFO							
Rep.	Référence	ALIAS	Désignation	Remplacé par	Date début	Date fin	Multiple de vente	Tarif Public Unitaire HT	
1	60002722		RESISTANCE THERMOPLONG. 12000W 12 KW				1	€ 181,18	
2	323506		RESISTANCE STEATITE 6000W L.1020 6 KW				1	€ 302,29	
3	60002724		THERMOSTAT DE REGULATION				1	€ 316,97	
4	336201		CONTRE BRIDE D.110				1	€ 63,27	
5	60002720		JOINT TORIQUE				1	€ 29,50	
7	338290		GAIN THERMOSTAT 1/2 L:350				1	€ 53,90	
8	345526		FOURREAU L.1100				1	€ 282,64	
9	60002719		BOUCHON 1/2				1	€ 57,71	
10	60002728		ENTRETOISE				1		
15	342068		ENJOLIVEUR DE TRAPPE				1	€ 43,35	
23	319513		ANODE D:21 L:997				1	€ 106,07	
26	60002727		BORNIER DE CONNEXION THERMOSTAT				1	€ 154,19	
30	918061		VIS M 10-32 TETE CARREE				1	€ 7,05	
31	918041		ECROU M 10				1	€ 3,84	
32	924002		JOINT D'EMBASE D170X105X5 TK150 6 TR	60003319			1	€ 17,46	
33	60002718		JOINT D'EMBASE	60003390			1	€ 108,30	
35	60002717		BRIDE SUP. + JOINT				1		
40	337521		CAPOT				1	€ 117,26	
43	337557		MANCHETTE				1	€ 145,71	