



Pièces de rechange

19/03/2024

<i>Produit</i>	893018 - top line 150 styx
<i>Modèle</i>	150L VERTICAL RESISTANCE A SEC
<i>Marque</i>	STYX
<i>Date</i>	11/04/2003

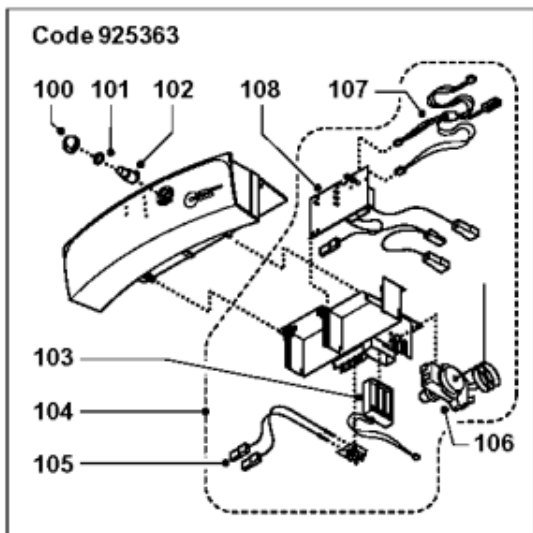
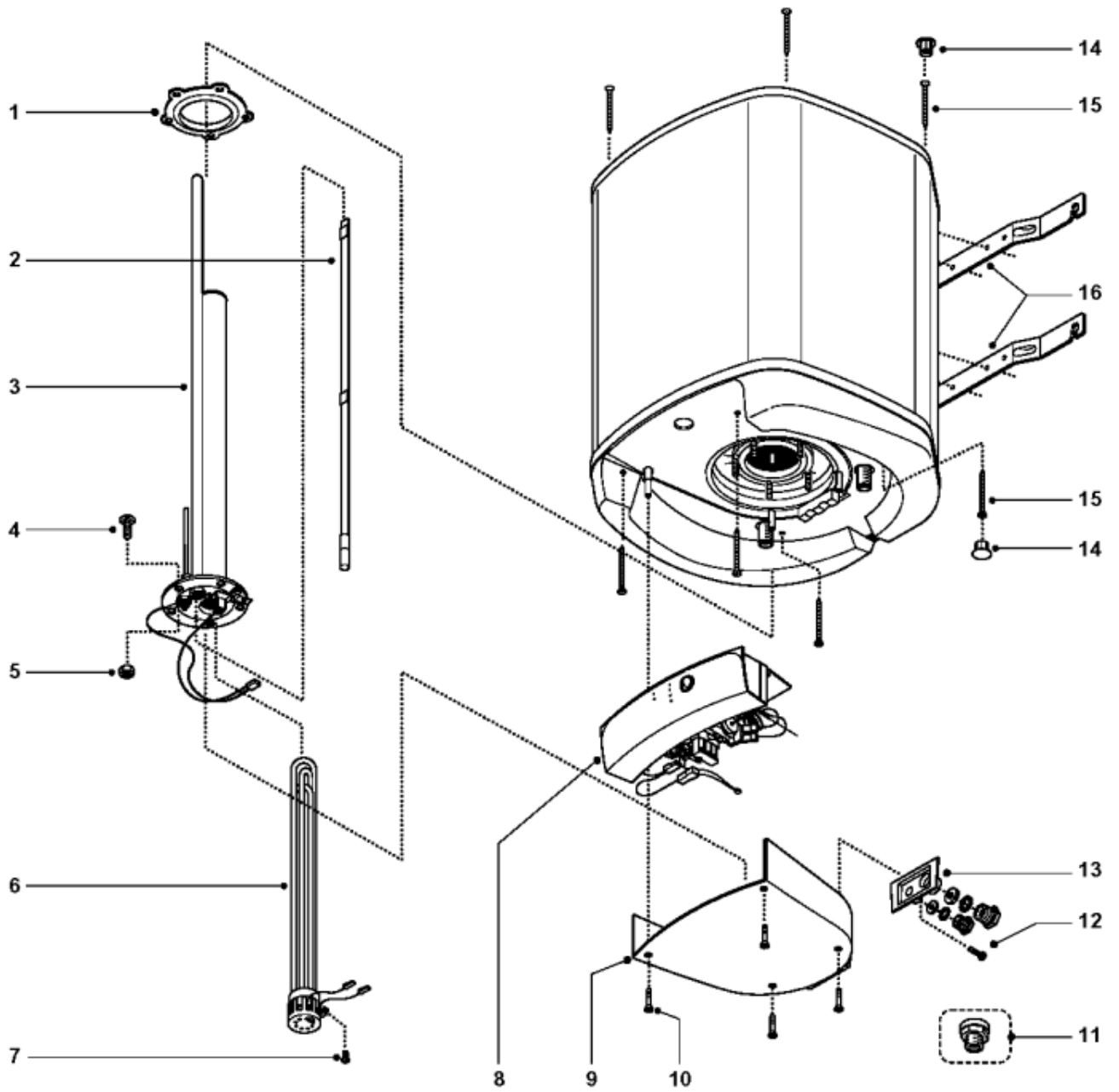

Table		TOP LINE 150/200 STYX							
Rep.	Référence	ALIAS	Désignation	Remplacé par	Date début	Date fin	Multiple de vente	Tarif Public Unitaire HT	
1	924001		JOINT BRIDE Ø 75 - 5 TROUS	60003308			1	€ 10,21	
2	925366		SONDE ELECTRONIQUE 150L				1	€ 75,98	
3	923159		EMBASE D.75 + ANODE				1		
4	918001		VIS M8X25				1	€ 1,86	
5	918004		ECROU FIXATION EMBASE M8				1	€ 4,18	
6	819312		RESISTANCE A SEC 2500W 230V D.40 L.56819306-01				1	€ 92,86	
7	918095		VIS M 5-10				1	€ 0,52	
8	925363		FACE AVANT PRECABLEE				1	€ 244,62	
9	926331		CAPOT				1	€ 17,64	
10	918120		VIS SW 4X18.5				1		
11	926195		RACCORDS DIELECTRI. 3/4-75 A 300L KIT 65118634				1	€ 15,43	
13	926071		SUPPORT PRESSE ETOUPE MONTE				1	€ 31,86	
14	570343		CAPUCHON D.10 POUR VIS				1		
15	918119		VIS D: 4-60				1		
16	912011		PATTE MURALE HT 12				1		
100	926343		BOUTON DE REGLAGE				1		
101	935354		JOINT O RING EPDM 9X1,5				1		
102	926344		AXE POTENTIOMETRE				1		
103	925340		BATTERIE 3X1,2V 1300 MAH	65101723			1	€ 68,56	
104	935348		CABLAGE COMPLET				1	€ 189,18	
106	921053		THERMOSTAT SECURITE A BULBE				1	€ 42,20	
107	935350		KIT CABLAGE SONDE-ANODE				1		
108	925347		CIRCUIT IMPRIME /				1	€ 181,27	