

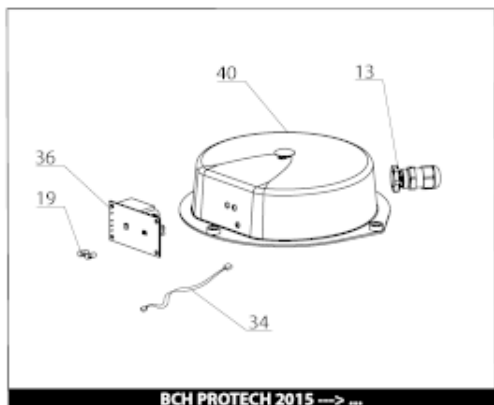

Pièces de rechange

19/03/2024

<i>Produit</i>	3070498 - BCH CD1 160 STY - EU
<i>Modèle</i>	BCH
<i>Marque</i>	STYX
<i>Date</i>	12/10/2020



BCH PROTECH 2015 → ...

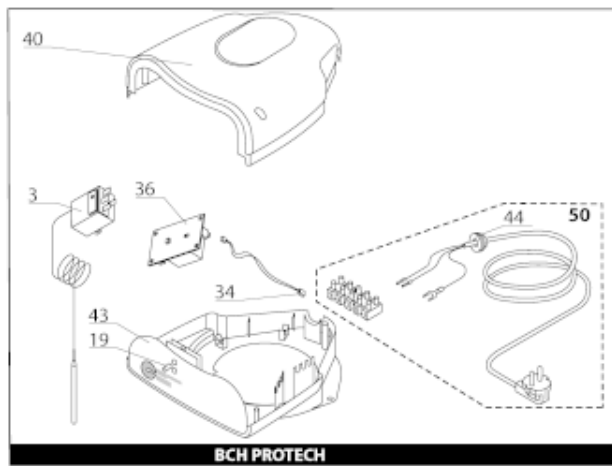

BCH PROTECH

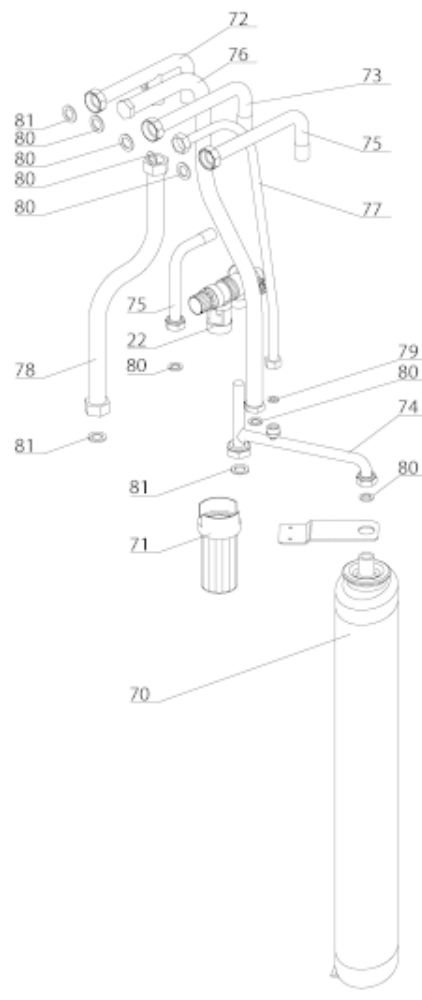
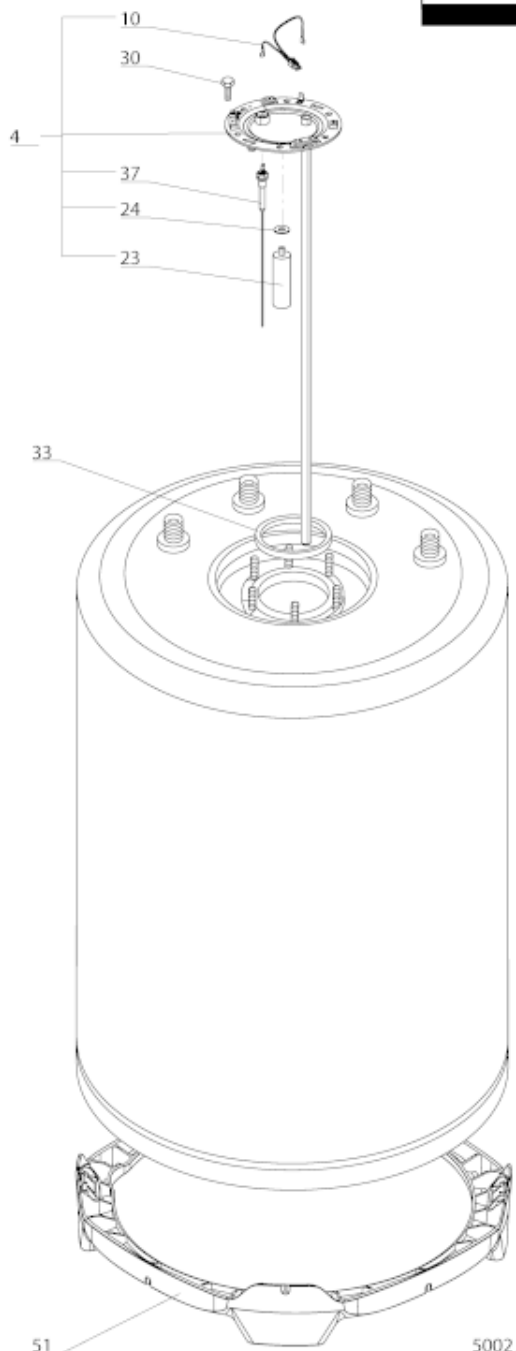

Table		BCH BCH erp							
Rep.	Référence	ALIAS	Désignation	Remplacé par	Date début	Date fin	Multiple de vente	Tarif Public Unitaire HT	
4	60001545		EMBASE + ANODES			10/20	1	€ 134,58	
4	60003368		EMBASE + ANODES		10/20		1	€ 66,26	
10	60001108-01		CABLAGE ELECTRODE - C.I.				1	€ 11,61	
13	60002560		PRESSE ETOUPE				1	€ 8,60	
19	998576		VITRE LED L=10.8				1	€ 2,32	
23	65103768-01		ANODE D21,3 L:110 M5-M8				1	€ 12,29	
24	61306237		JOINT ANODE	60003413			1	€ 3,71	
30	60000681		VIS DE FIXATION EMBASE M 8-14 (6 ST.)	61005231			10	€ 1,73	
33	60003285		JOINT BRIDE	60000682	10/20		1	€ 5,42	
33	60071829		JOINT BRIDE D:121.3-105-7.1			10/20	1	€ 3,78	
34	60000475		CABLAGE ELECTRODE > C.I.				1	€ 9,77	
36	925348-01		CIRCUIT IMPRIME ANODE / ELECTR.				1	€ 124,34	
37	60002112		ANODE PROTECH				1	€ 35,01	
40	60002559		COUVERCLE BOITIER				1	€ 17,31	
51	60000803		SUPPORT D:505-560				1	€ 34,29	
5002	912006		PATTE MURALE D:470-505-560-570				1	€ 23,26	