

Pièces de rechange

19/03/2024

<i>Produit</i>	3070469 - BC1S CD1 200 STY - EU 2
<i>Modèle</i>	BC
<i>Marque</i>	NEUTRO
<i>Date</i>	28/08/2020

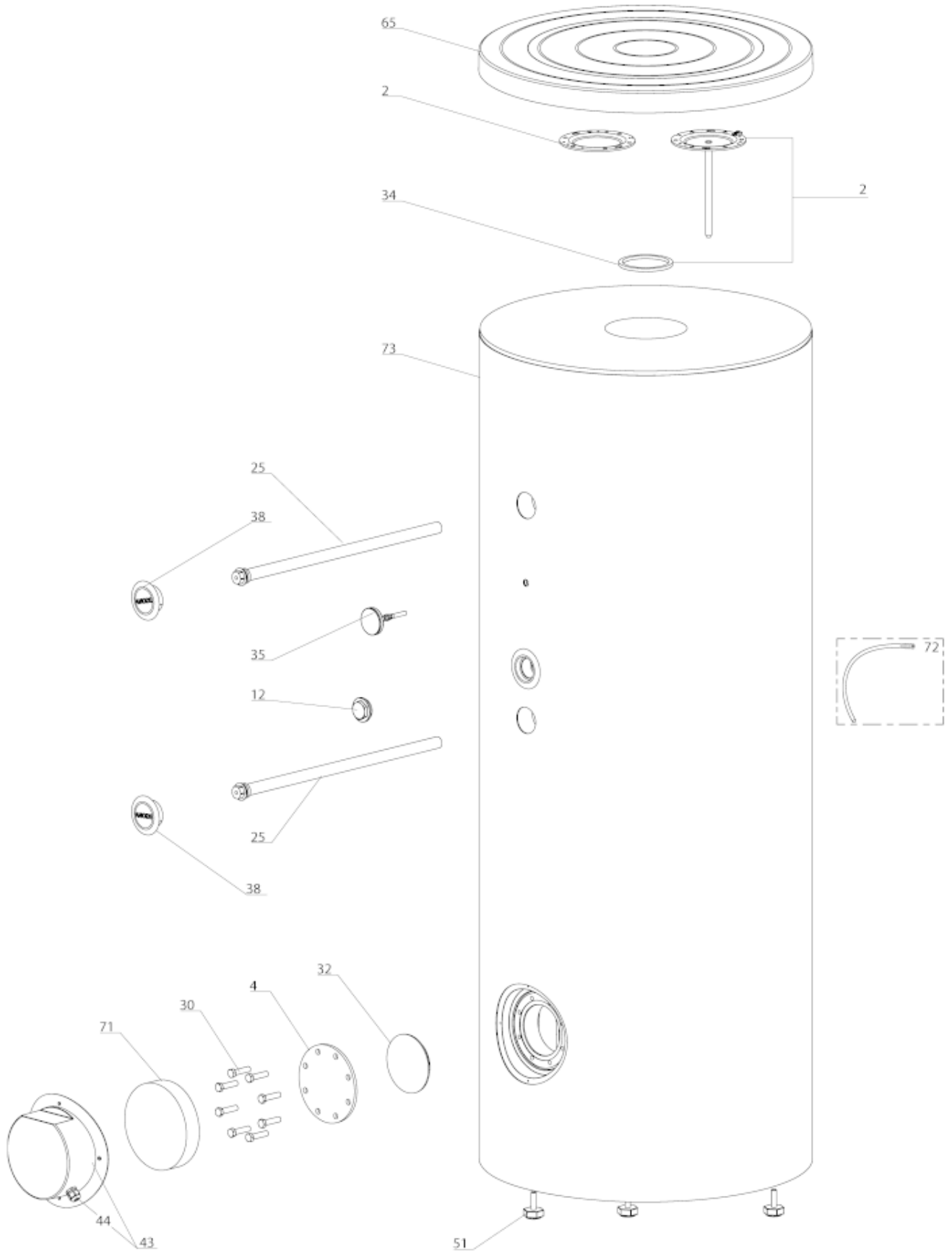

Table		BC1S/2S - 2							
Rep.	Référence	ALIAS	Désignation	Remplacé par	Date début	Date fin	Multiple de vente	Tarif Public Unitaire HT	
2	60001113		BRIDE D.105				1	€ 26,44	
2	60003014		EMBASE D.105				1	€ 67,18	
4	60002557		BRIDE Ø180 8 TROUS				1	€ 24,35	
12	61310637		BOUCHON + JOINT				1	€ 14,06	
25	60002187-01		ANODE MG Ø26 L450 PTFE*				1	€ 42,07	
30	60002556		VIS HEX. M12X30				1	€ 2,38	
32	60002558		JOINT EPDM SHORE 70 BRIDE Ø180				1	€ 3,15	
34	60071829		JOINT BRIDE D:121.3-105-7.1				1	€ 3,78	
35	60002867		THERMOMETRE/				1	€ 16,28	
38	60002868		BOUCHON Ø60				1	€ 2,96	
43	60002865		CAPOT				1	€ 27,70	
44	60002866		PRESSE ETOUPE				1	€ 8,74	
51	65152260		PIED REGLABLE				1	€ 6,48	
65	60002919		DOME PLASTIC Ø650				1	€ 34,23	
71	60002555		ISOLANT AIGUILÉNE D210				1	€ 12,45	
72	60002904		TUBE EAU CHAUDE				1	€ 14,97	
72	60002905		TUBE EAU FROIDE				1	€ 13,70	
73	60002900		JAQUETTE Ø650 200L				1	€ 88,35	