

SCHEDE: I050 / I023

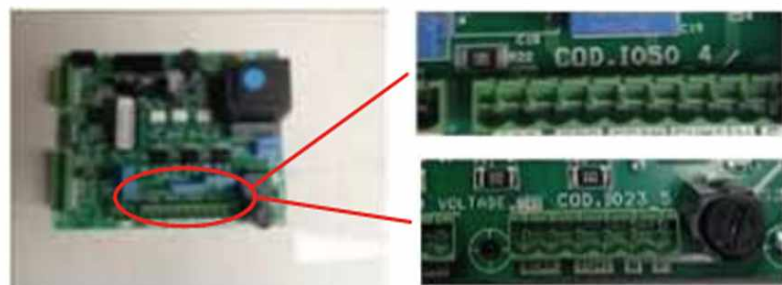
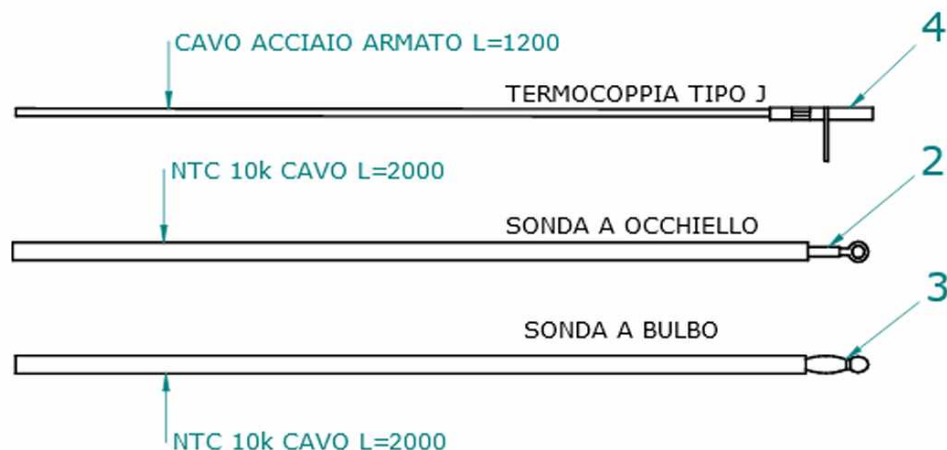

TERMOCOPPIA: Utilizzare tipo "J" / Thermocouple type "J"
Rispettare la polarità / You must ensure the polarity into clamp
Non fare giunzioni. / Do not make junction

NTC 10K Uguali per tutte le schede / NTC probe 10K are the same for all the PCB

LUNGHEZZA Lunghezza standard 2 MT eventualmente adattare // Standard length 2 meters. You can extend the wire up to 5 meters with standard wire otherwise use shield wire

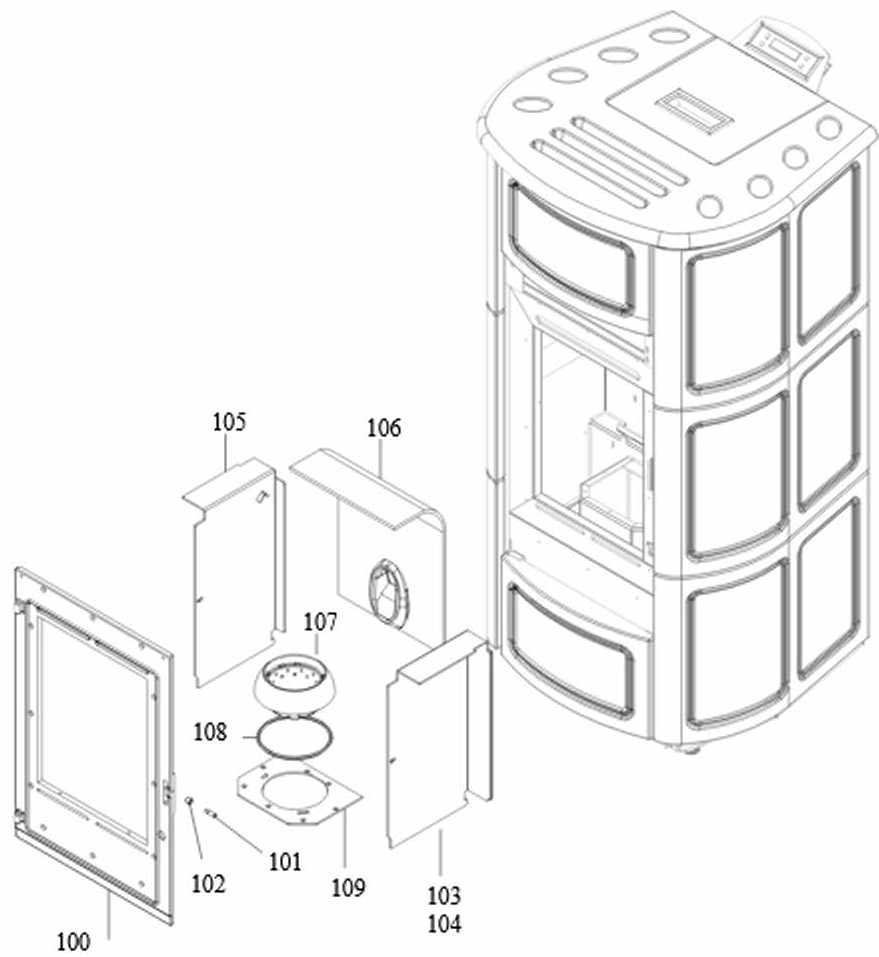

892005490 - KIT GRUPPO CARICO STELLA V10_BD

