

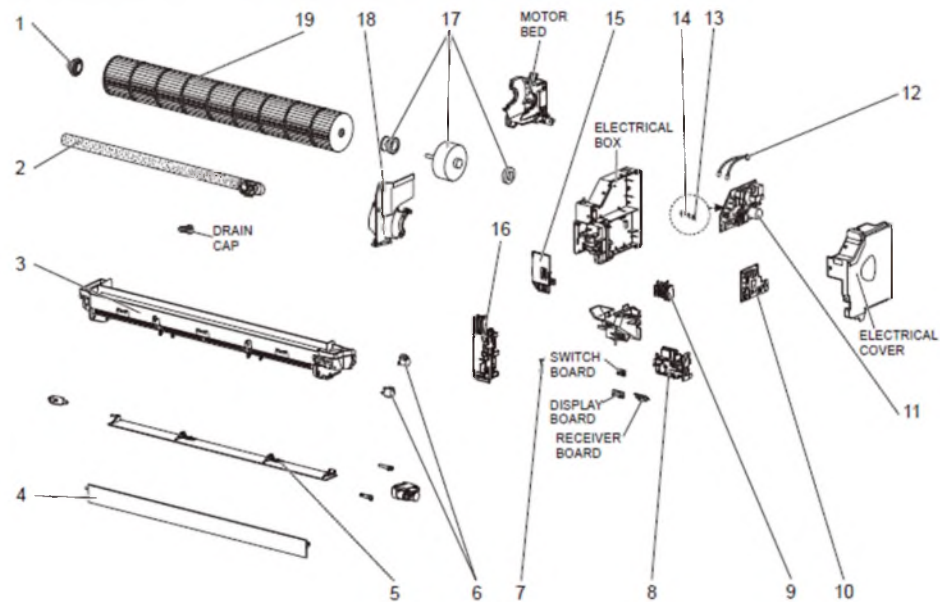

















- MSZ-EF18VGW - [X] MSZ-EF18VGB - [X] MSZ-EF18VGS - [X]
- MSZ-EF22VGW - [X] MSZ-EF22VGB - [X] MSZ-EF22VGS - [X]
- MSZ-EF25VGW - [X] MSZ-EF25VGB - [X] MSZ-EF25VGS - [X]
- MSZ-EF35VGW - [X] MSZ-EF35VGB - [X] MSZ-EF35VGS - [X]
- MSZ-EF42VGW - [X] MSZ-EF42VGB - [X] MSZ-EF42VGS - [X]
- MSZ-EF50VGW - [X] MSZ-EF50VGB - [X] MSZ-EF50VGS - [X]

1-7. INDOOR UNIT ELECTRICAL PARTS AND FUNCTIONAL PARTS



MSZ-EF18VGW -  MSZ-EF18VGB -  MSZ-EF18VGS - 
MSZ-EF22VGW -  MSZ-EF22VGB -  MSZ-EF22VGS - 
MSZ-EF25VGW -  MSZ-EF25VGB -  MSZ-EF25VGS - 
MSZ-EF35VGW -  MSZ-EF35VGB -  MSZ-EF35VGS - 
MSZ-EF42VGW -  MSZ-EF42VGB -  MSZ-EF42VGS - 
MSZ-EF50VGW -  MSZ-EF50VGB -  MSZ-EF50VGS - 

1-5. INDOOR UNIT STRUCTURAL PARTS

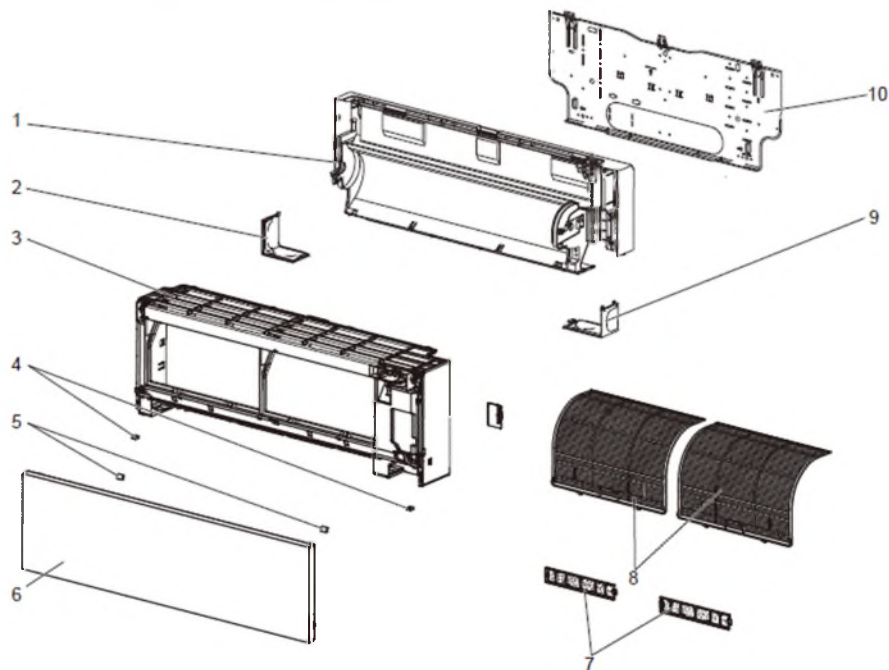

1-6. ACCESSORY AND REMOTE CONTROLLER

