













1604

CORPS CHAUDIERE IDEAL 2300

IDEAL 2300 - R3

Réf.	Référence	Description	Qté	Tarif	Substitué	Tarif Sub.	Remarques
1	S1780047	ELEMENT AVANT NXR3	1	Nous consulter...			
-1	S1712630	CORPS NU MONTE NXR38/2300.8	1	Nous consulter...			⊘
-1	S1712630	CORPS NU MONTE R34	1	Nous consulter...			⊘
-1	S1712630	CORPS NU MONTE R35	1	Nous consulter...			⊘
-1	S1712630	CORPS NU MONTE R37	1	Nous consulter...			⊘
-1	S1712630	CORPS NU MONTE R39	1	Nous consulter...			⊘
-1	S1712630	CORPS NU MONTE R38	1	Nous consulter...			⊘
2	S1780049	ELEMENT INTER NXR3	1	Nous consulter...			
3	S1780048	ELEMENT ARRIERE NXR3	1	Nous consulter...			⊘
4	S1780940	BAGUE ASSEMBLAGE INF A4	1				
4	S1780940	BAGUE ASSEMBLAGE INF A4	1				
4	S1780940	BAGUE ASSEMBLAGE INF A4	1				
5	S1700016	TRESSE DE 7 SILICONEE (LE M)	1				
6	S1707715	TRINGLE ASS.CPLT 6 ELE.12X960	1	Nous consulter...			⊘
6	S1707715	TRINGLE ASS.CPLT 6 ELE.12X960	1	Nous consulter...			⊘
6	S1707715	TRINGLE ASS.CPLT 8 ELE.12X1300	1	Nous consulter...			⊘
6	S1707715	TRINGLE ASS.CPLT 8 ELE.12X1300	1	Nous consulter...			⊘
6	S1707715	TRINGLE ASS.CPLT 4 ELE.12X620	1	Nous consulter...			⊘
6	S1707715	TRINGLE ASS.CPLT 4 ELE.12X620	1	Nous consulter...			⊘
6	S1707715	TRINGLE ASS.CPLT 9 ELE.12X1470	1	Nous consulter...			⊘
6	S1707715	TRINGLE ASS.CPLT 9 ELE.12X1470	1	Nous consulter...			⊘
6	S1707715	TRINGLE ASS.CPLT 7 ELE.12X1130	1	67,80 €			
6	S1707715	TRINGLE ASS.CPLT 7 ELE.12X1130	1	67,80 €			
6	S1707715	TRINGLE ASS.CPLT 5 ELE.12X790	1	Nous consulter...			⊘
6	S1707715	TRINGLE ASS.CPLT 5 ELE.12X790	1	Nous consulter...			⊘
7	S1592265	REDUCTION GF No241 2"X1/2"	1	51,10 €			
8	S1788006	DOIGT GANT 1/2"+RESSORT+CLIP	1	Nous consulter...			⊘
9	S1784565	GOND DE PORTE	1	Nous consulter...			⊘
9A	S1784563	PAUMELLE DE PORTE	1	59,40 €			
10	S1784562	GUIDE DE PORTE	1	14,60 €			
11	S1700031	AXE DE PORTE	1	Nous consulter...			⊘
11	S1700031	AXE DE PORTE	1	Nous consulter...			⊘
12	S1700077	BRIDE A SOUDER DN65	1	159,00 €			
12	S1700077	BRIDE A SOUDER DN65	1	159,00 €			
13	S1560182	JOINT 118X82	1	27,40 €			
13	S1560182	JOINT 118X82	1	27,40 €			
13	S1560182	JOINT 118X82	1	27,40 €			
14	S1707609	REPARTITEUR P/CORPS 6/7 ELEM.	1	Nous consulter...			⊘
14A	S1707609	REPARTITEUR P/CORPS 8/9 ELEM.	1	Nous consulter...			⊘
15	S1786429	MANCHETTE DEPART RETOUR	1	Nous consulter...			⊘
15	S1786429	MANCHETTE DEPART RETOUR	1	Nous consulter...			⊘
16	S1700647	ROBINET VIDANGE 20X27	1	35,20 €			
17	S1707092	DOIGT GANT SONDE GESTION+CL	1	115,00 €			
18	S1730043	JEUX ECONOMISEUR SUP.P/8-9 EL	1	Nous consulter...			⊘
18	S1730043	JEUX ECONOMISEUR SUP.P/5 ELE	1	Nous consulter...			⊘
18	S1730043	JEUX ECONOMISEUR SUP.P/4 ELE	1	Nous consulter...			⊘
18	S1730043	JEUX ECONOMISEUR SUP.P/6-7 EL	1	Nous consulter...			⊘
18A	S1730033	JEUX ECONOMISEUR INF.P/4 ELEM	1	Nous consulter...			⊘
18A	S1730033	JEUX ECONOMISEUR INF.P/5 ELEM	1	Nous consulter...			⊘

IDEAL 2300 - R3

18A	S1730033	JEUX ECONOMISEUR INF.P/8-9 EL.	1	Nous consulter...	
18A	S1730033	JEUX ECONOMISEUR INF.P/6-7 EL.	1	Nous consulter...	
19	S1786425	BOITE A FUM.ASS.D=180 4A7 ELTS	1		
19A	S1786426	BOITE A FUM.EES D=200 P/8-9 EL.	1	Nous consulter...	
20	S1784566	TAMPON RAMONAGE B.A.F GAUCH	1	70,40 €	
20A	S1784567	TAMPON RAMONAGE B.A.F DROIT	1	70,40 €	
21	S1700016	TRESSE FIBRE DE VERRE D=8	1	30,20 €	
22	S1786427	PORTE FOYER EQUIPEE R3	1	Nous consulter...	
22	S1786427	R3 PORTE FOYER USINEE	1	183,00 €	
23	S1700363	ISOLATION INTERMED.PT FOYER	1	Nous consulter...	
23	S1700363	ISOLATION INTERIEURE PT FOYEF	1	49,80 €	
24	S1707217	ISOLATION EXTER.PT FOYER + VIS	1	127,00 €	
25	S1784564	BRIDE DE VOYANT	1		
26	S1707808	VERRE DE VOYANT + JOINT	1	72,50 €	
27	S1700019	TRESSE RONDE DE 16 (LE M) BLAN	1	19,20 €	
27	S1700019	TRESSE RONDE DE 16 (LE M) BLAN	1	19,20 €	
28	S1707526	PLAQUE BRUL.OUVRAN.SER.3 PLE	1	Nous consulter...	
28	S1700580	PLAQUE SUPPORT BRULEUR PERC	1	Nous consulter...	
29	S1700366	ISOLANT BRUL.XR3 PTE OUVRANT	1	29,30 €	
30	S1786428	PORTE RAMONAGE EQUIPEE	1	318,00 €	
31	S1700366	ISOLATION INTERIEURE PT RAMOI	1	64,20 €	
32	S1707217	ISOLATION EXTER.PT RAMON.+ VI:	1	182,00 €	
33	S1493100	CALORIFUGE EP=50 (LE M)	1	49,90 €	
33	S1493100	CALORIFUGE EP=50 (LE M)	1	49,90 €	
39	S1700200	BROSSE ACIER LG=1760	1	Nous consulter...	
39	S1700201	GOUPILLON D60 ACIER LONG 125	1	Nous consulter...	
40	S1788014	SACHET VIS.CORPS NXR3/2300	1		
41	S1784568	KIT PIED REGLABLE CPLT	1	Nous consulter...	

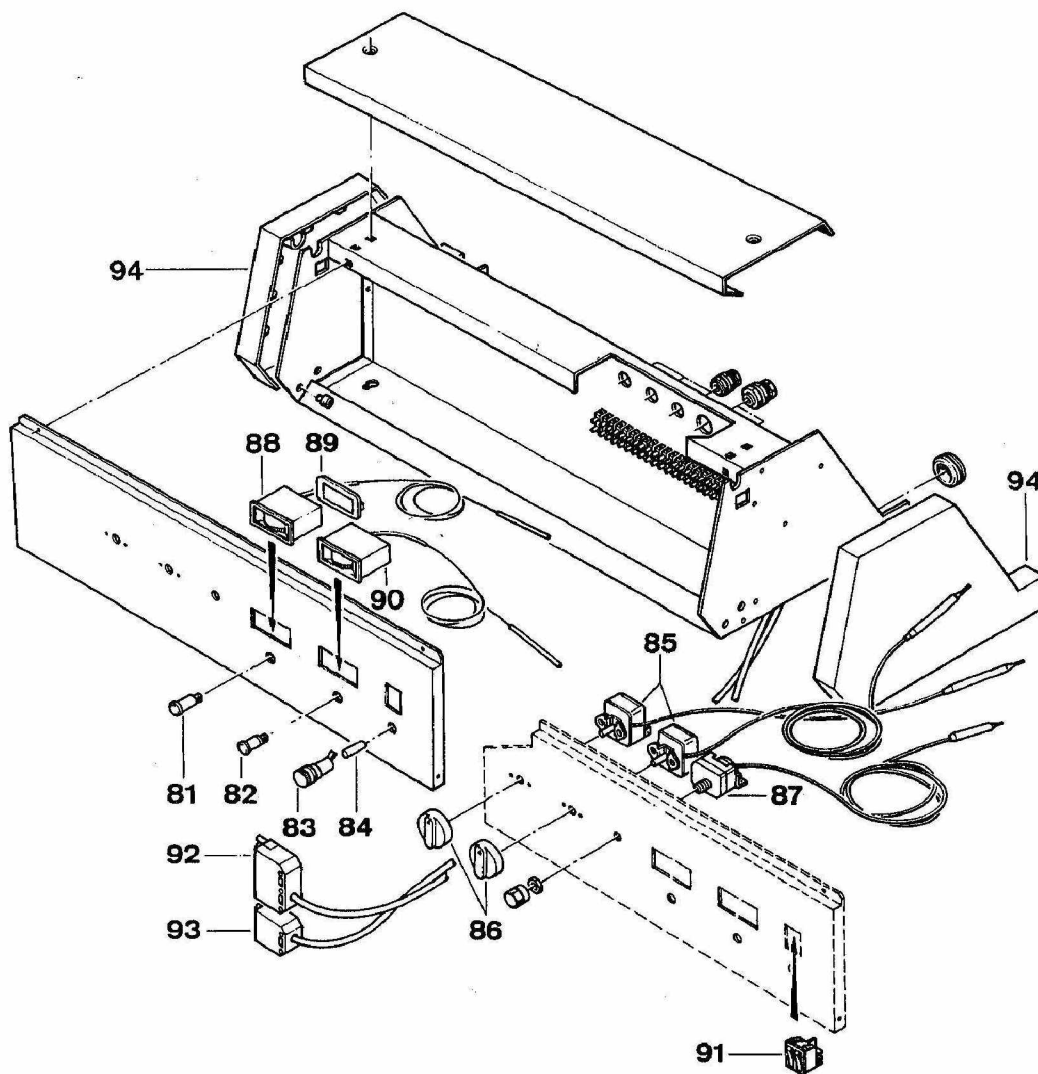

1606

TABLEAU DE COMMANDE VERSION "B"

IDEAL 2300 - R3

Réf.	Référenc	Description	Qté	Tarif	Substitut	Tarif Sub.	Remarques
80	S1720247	TABLEAU COMMANDE CABLE "B"	1	Nous consulter...			⊘
81	S1583826	VOYANT LS 5 K ROUGE D=12	1	Nous consulter...			⊘
82	S1583826	VOYANT LS 5 A B5 ORANGE D=12	1	Nous consulter...			⊘
83	S1580399	PORTE FUSIBLE	1				
84	S1580352	FUSIBLE 6.3 AMPERES 5X20	1	6,80 €			
85	S1700699	THERMOSTAT RAK 51.41.71	1				
86	S1700473	MANETTE THERMOSTAT	1	3,70 €			
87	S1700694	THERMOSTAT RAK 77.44.71	1	33,20 €			
88	S1700706	THERMOMETRE RECT.20Â°A120Â°	1	18,30 €			
89	S1700228	CACHE THERMOMETRE	1	1,65 €			⊘
90	S1700695	THERMOMETRE FUMÉES RECTAN	1	Nous consulter...			⊘
91	S1580408	INTERRUPTEUR DOUBLE TEST	1	Nous consulter...			⊘
92	S1707718	CABLE BRULEUR 1 ALLURE	1	213,00 €			
93	S1707718	CABLE BRULEUR 2EME ALLURE	1	109,00 €			
94	S1700229	COTE GAUCHE BANDEAU"B"	1	Nous consulter...			⊘
94	S1700229	COTE GAUCHE BANDEAU"B"	1	Nous consulter...			⊘
94	S1700228	COTE DROIT BANDEAU"B"	1	Nous consulter...			⊘
94	S1700228	COTE DROIT BANDEAU"B"	1	Nous consulter...			⊘
95	S1788016	SACHET ACCES.ET VIS BANDEAU"	1	Nous consulter...			⊘

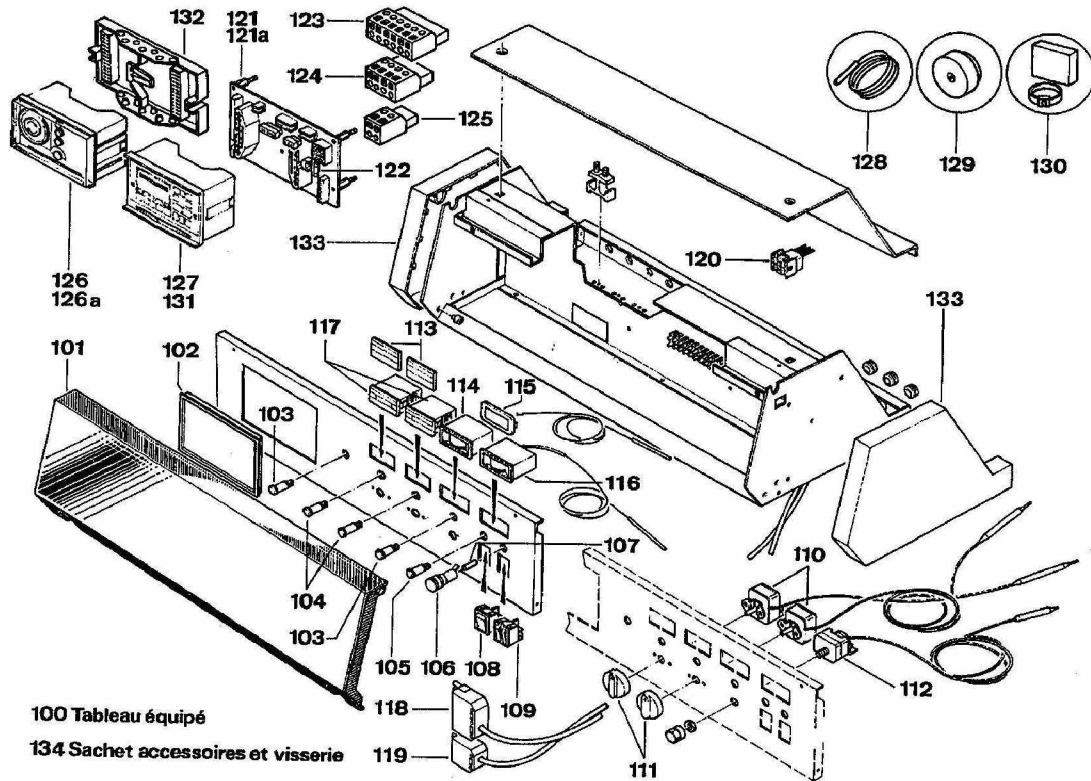

1607

TABLEAU DE COMMANDE VERSION "R"

IDEAL 2300 - R3

Réf.	Référence	Description	Qté	Tarif	Substitué	Tarif Sub.	Remarques
-1	S1793768	DESSUS TABLEAU R3 JAUNE	1	Nous consulter...			⊘
-1	S1793767	FACADE TABLEAU COMMANDE R3	1	Nous consulter...			⊘
-1	S1793764	FOND DE TABLEAU R3	1	Nous consulter...			⊘
100	S1720247	BANDEAU CABLE "R"	1	Nous consulter...			⊘
101	S1700385	ECRAN DE PROTECTION	1	Nous consulter...			⊘
102	S1700559	PLATINE D'OBTURATION	1	14,70 €			
103	S1583826	VOYANT LS 5 K ROUGE D=12	1	Nous consulter...			⊘
103	S1583826	VOYANT LS 5 K ROUGE D=12	1	Nous consulter...			⊘
104	S1583826	VOYANT VERT D=12	1	Nous consulter...			⊘
105	S1583826	VOYANT LS 5 A B5 ORANGE D=12	1	Nous consulter...			⊘
106	S1580399	PORTE FUSIBLE	1				
107	S1580352	FUSIBLE 6.3 AMPERES 5X20	1	6,80 €			
108	S1580402	INTERRUPTEUR 300 B5 NN	1	Nous consulter...			⊘
109	S1580408	INTERRUPTEUR DOUBLE TEST	1	Nous consulter...			⊘
110	S1700699	THERMOSTAT RAK 51.41.71	1				
111	S1700473	MANETTE THERMOSTAT	1	3,70 €			
112	S1700694	THERMOSTAT RAK 77.44.71	1	33,20 €			
113	S1700226	CACHE COMPTEUR	1	Nous consulter...			⊘
114	S1700706	THERMOMETRE RECT.20Å°A120Å°	1	18,30 €			
115	S1700228	CACHE THERMOMETRE	1	1,65 €			⊘
116	S1700695	THERMOMETRE FUMÉES RECTAN	1	Nous consulter...			⊘
117	S1700121	COMPTEUR HORAIRE FWZ	1	Nous consulter...			⊘
118	S1707718	CABLE BRULEUR 1 ALLURE	1	213,00 €			
119	S1707718	CABLE BRULEUR 2EME ALLURE	1	109,00 €			
120	S1707075	CONNECTEUR DE REGUL.AVEC C/	1	18,60 €			
120	S1707075	CONNECTEUR RACCORD T/B	1	Nous consulter...			⊘
121	S1707064	CIRCUIT IMPRIME CI.1004	1	Nous consulter...			⊘
121A	S1707064	CIRCUIT IMPRIME CI.21004	1	Nous consulter...			⊘
122	S1580359	FUSIBLE VERRE T4A D=5X20	1	3,50 €			
123	S1580263	CONNECTEUR 6V.WAGO 231.306	1	Nous consulter...			⊘
124	S1580262	CONNECTEUR 4VOIES WAGO 231.	1	Nous consulter...			⊘
125	S1580263	CONNECTEUR 2VOIES WAGO 231.	1	18,60 €			
126	S1700635	REGULATEUR RVP41.100 (RA1010)	1	Nous consulter...			⊘
127	S1700624	REGULAT.RVP75.230/1009(RD3032	1	Nous consulter...			⊘
128	S1720211	SONDE CHAUDIERE QAZ21 2M	1				
129	S1720211	SONDE EXTERIEURE QAC 31	1	Nous consulter...			⊘
130	S1720211	SONDE DE DEPART QAD 21	1	Nous consulter...			⊘
130	S1720211	SONDE DE DEPART QAD 21	1	Nous consulter...			⊘
130	S1700681	SONDE DEPART QAD21 (GP:1	1	81,20 €			
130	S1700681	SONDE DEPART QAD21 (GP:1	1	81,20 €			
131	S1700624	REGULAT.RVP45.500/1009(RD1011	1	Nous consulter...			⊘
132	S1700678	SOCLE AGS 90.2	1	Nous consulter...			⊘
133	S1700229	COTE GAUCHE BANDEAU"B"	1	Nous consulter...			⊘
133	S1700228	COTE DROIT BANDEAU"B"	1	Nous consulter...			⊘
134	S1788034	SACHET ACCES.ET VIS BANDEAU"	1	Nous consulter...			⊘

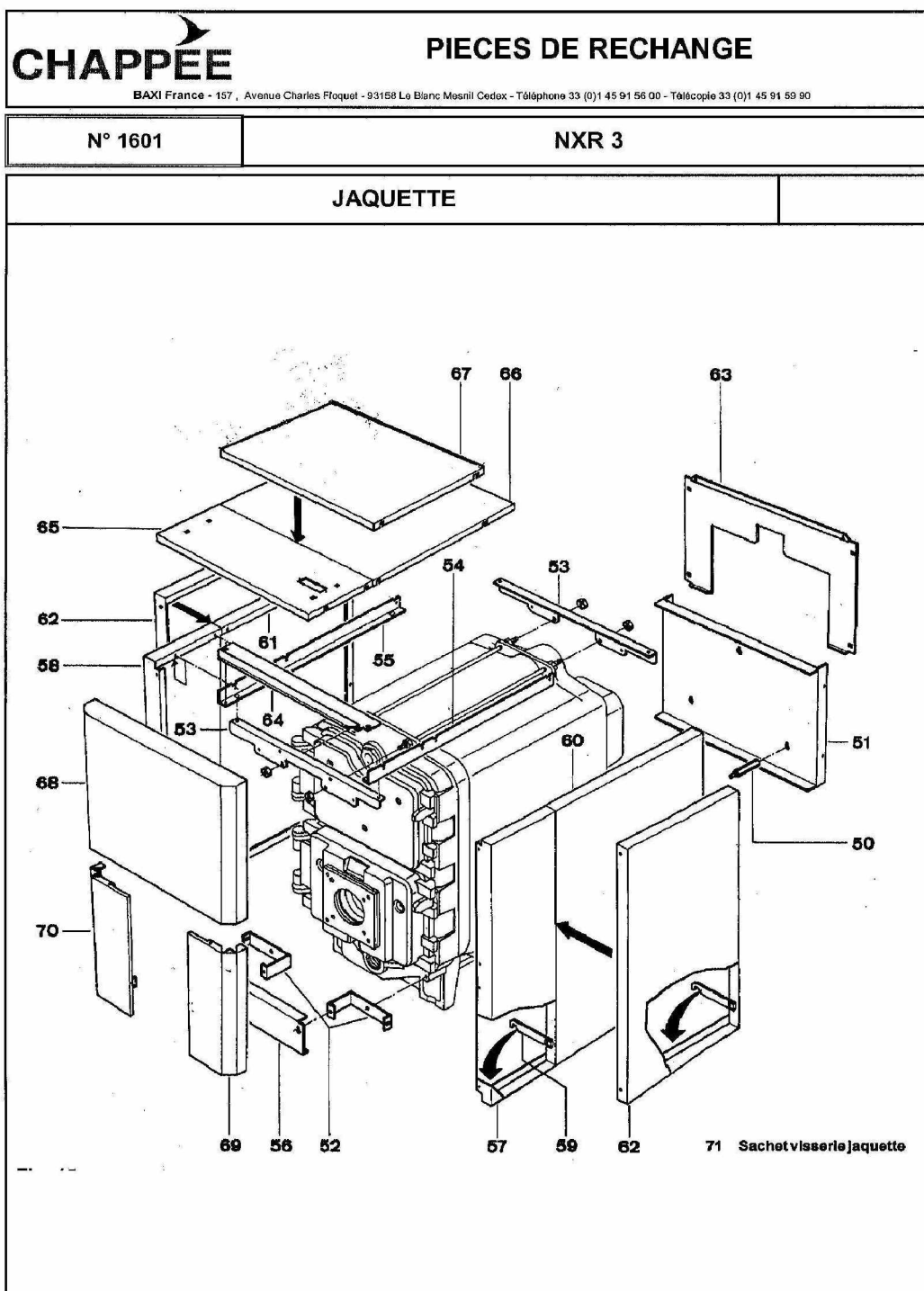



































18/09/2006

1601-NXR3-JAQUETTE.xls

IDEAL 2300 - R3

Réf.	Référence	Description	Qté	Tarif	Substitué	Tarif Sub.	Remarques
50	S1700211	ENTRETOISE ARRIERE	1	10,90 €			
51	S1793750	PANNEAU ARRIERE INFERIEUR	1	Nous consulter...			⊘
52	S1793743	PATTE INFERIEURE EQUIPEE	1	159,00 €			
53	S1793736	TRAVERSE SUPERIEURE	1	32,90 €			
53	S1793736	TRAVERSE SUPERIEURE	1	32,90 €			
54	S1793737	LONGERON DROIT P/CORPS 4 ELE	1	Nous consulter...			⊘
54	S1793741	LONGERON DROIT P/CORPS 8 ELE	1	Nous consulter...			⊘
54	S1793739	LONGERON DROIT P/CORPS 6 ELE	1	Nous consulter...			⊘
54	S1793738	LONGERON DROIT P/CORPS 5 ELE	1	Nous consulter...			⊘
54	S1793740	LONGERON DROIT P/CORPS 7 ELE	1	Nous consulter...			⊘
54	S1793742	LONGERON DROIT P/CORPS 9 ELE	1	Nous consulter...			⊘
55	S1793742	LONGERON GAUCHE P/CORPS 9 E	1	Nous consulter...			⊘
55	S1793737	LONGERON GAUCHE P/CORPS 4 E	1	Nous consulter...			⊘
55	S1793738	LONGERON GAUCHE P/CORPS 5 E	1	Nous consulter...			⊘
55	S1793740	LONGERON GAUCHE P/CORPS 7 E	1	Nous consulter...			⊘
55	S1793739	LONGERON GAUCHE P/CORPS 6 E	1	Nous consulter...			⊘
55	S1793741	LONGERON GAUCHE P/CORPS 8 E	1	Nous consulter...			⊘
56	S134355C	CACHE INFERIEUR - FB 90-130-17C	1	Nous consulter...			⊘
56	S134355E	CACHE INFERIEUR (BROTJE)	1	Nous consulter...			⊘
56	S1793758	CACHE INFERIEUR NXR3	1	Nous consulter...			⊘
57	S1793774	COTE AVANT DROIT EQUIPE NXR3	1	Nous consulter...			⊘
57	S134321C	ENSEMBLE COTE AVANT DROIT - F	1	Nous consulter...			⊘
57	S134321E	ENS. COTE AVANT DROIT FB90-130	1	Nous consulter...			⊘
58	S134320E	ENS.COTE AV GAUCHE FB90-130-1	1	Nous consulter...			⊘
58	S1793774	COTE AVANT GAUCHE EQUIPE NXI	1	Nous consulter...			⊘
58	S134320C	ENSEMBLE COTE AVANT GAUCHE	1	Nous consulter...			⊘
59	S1793745	BUTEE DE COTE	1	Nous consulter...			⊘
60	S1793778	COTE ARR.DROIT NXR3 4/7 ROUGE	1	Nous consulter...			⊘
60	S501389	COTE ARR.DROIT NXR3 6/9 BLANC	1	Nous consulter...			⊘
60	S501387	COTE ARR.DROIT NXR3 4/7 BLANC	1	Nous consulter...			⊘
60	S501388	COTE ARR.DROIT NXR3 5/8 BLANC	1	Nous consulter...			⊘
60	S506308	ENS. COTE AR. DROIT - FB90-130-1	1	Nous consulter...			⊘
60	S506304	ENS COTE AR DROIT FB90-130-170	1	Nous consulter...			⊘
60	S1793781	COTE ARR.DROIT NXR3 5/8 ROUGE	1	Nous consulter...			⊘
60	S1793784	COTE ARRIERE DROIT NXR3 6/9 EL	1	Nous consulter...			⊘
60	S506306	ENS. COTE AR. DROIT - FB90-130-1	1	Nous consulter...			⊘
61	S1793781	COTE ARRIERE GAUCH.NXR3 5/8 E	1	Nous consulter...			⊘
61	S506305	ENS. COTE AR GAUCHE FB90-130-	1	Nous consulter...			⊘
61	S506309	ENS. COTE AR. GAUCHE - FB90-130	1	Nous consulter...			⊘
61	S1793778	COTE ARRIERE GAUCH.NXR3 4/7 E	1	Nous consulter...			⊘
61	S501390	COTE ARR.GAUCH.NXR3 4/7 BLANC	1	Nous consulter...			⊘
61	S501391	COTE ARR.GAUCH.NXR3 5/8 BLANC	1	Nous consulter...			⊘
62	S1793749	COTE INTER.NXR3 7/8/9 ROUGE	1	Nous consulter...			⊘
62	S506312	ENS.COTE INTERMED.- FB90-130-1	1	Nous consulter...			⊘
62	S501404	COTE INTER.NXR3 7/8/9 BLANC.	1	Nous consulter...			⊘
63	S501405	PANNEAU ARRIERE SUPERIEUR BI	1	Nous consulter...			⊘
63	S1793751	PANNEAU ARRIERE SUPERIEUR R	1	Nous consulter...			⊘
64	S1793752	DEFLECTEUR	1	36,70 €			
65	S1793753	DESSUS AVANT NXR3 ROUGE	1	Nous consulter...			⊘

65	S139165A	DESSUS AVANT R3 ROUGE	1	Nous consulter...	
65	S140316E	DESSUS AVANT R3	1	Nous consulter...	
65	S139165C	DESSUS AVANT NXR3 BLANC	1	Nous consulter...	
66	S120861E	DESSUS ARRIERE - FB 90-130-170-	1	Nous consulter...	
66	S120862C	DESSUS ARRIERE NXR3 6/9 BLANC	1	Nous consulter...	
66	S120860C	DESSUS ARRIERE NXR3 4/7 BLANC	1	Nous consulter...	
66	S120860E	DESSUS ARRIERE 514-FB-(R3)	1	Nous consulter...	
66	S120861C	DESSUS ARRIERE NXR3 5/8 BLANC	1	Nous consulter...	
66	S1793754	DESSUS ARRIERE NXR3 4/7 ROUG	1	Nous consulter...	
66	S1793755	DESSUS ARRIERE NXR3 5/8 ROUG	1	Nous consulter...	
66	S1793756	DESSUS ARRIERE NXR3 6/9 ROUG	1	Nous consulter...	
67	S1793757	DESSUS INTER.NXR3 7/8/9 ROUGE	1	Nous consulter...	
67	S120862E	DESSUS ARRIERE - FB 90-130-170-	1	Nous consulter...	
67	S120997C	DESSUS INTERMEDIAIRE BLANC	1	Nous consulter...	
67	S120997E	DESSUS INTERMEDIAIRE - FB90-13	1	Nous consulter...	
68	S501401	ENS. FACADE SUP. AV. -FB90-130-	1	Nous consulter...	
68	S1793761	FACADE SUPERIEURE NXR3 ROUC	1	Nous consulter...	
68	S1700239	AIMANT AIRELEC 52760	1	13,50 €	
68	S506636	ENS.FACADE SUP. AVANT NXR3 BF	1	Nous consulter...	
68	S505594	ENS.FACADE AV SUP. R3 ROUGE F	1	Nous consulter...	
69	S1793776	FACADE INFERIEURE DROITE NXR	1	Nous consulter...	
69	S506302	ENS. FACADE INF. DROITE FB90-13	1	Nous consulter...	
69	S501403	FACADE INFERIEURE DROITE NXR	1	Nous consulter...	
70	S1793776	FACADE INFERIEURE GAUCHE NXI	1	Nous consulter...	
70	S501402	FACADE INFERIEURE GAUCHE NXI	1	Nous consulter...	
70	S506303	ENS.FACADE INF. GAUCHE FB90-13	1	Nous consulter...	
71	S1788014	SACHET VIS.JAQUETTE NXR3/230C	1	136,00 €	
999	S1722183	JAQUETTE COMPLETE NXR34 ROL	1	Nous consulter...	
999	S1722183	JAQUETTE COMPLETE NXR39	1	Nous consulter...	
999	S1722183	JAQUETTE COMPLETE NXR37	1	Nous consulter...	
999	S1722183	JAQUETTE COMPLETE NXR35	1	Nous consulter...	
999	S1722194	JAQUETTE COMPLETE NXR38 BLA	1	Nous consulter...	
999	S1722194	JAQUETTE COMPLETE NXR34 BLA	1	Nous consulter...	
999	S1722194	JAQUETTE COMPLETE NXR35 BLA	1	Nous consulter...	
999	S1722194	JAQUETTE COMPLETE NXR36 BLA	1	Nous consulter...	
999	S1722194	JAQUETTE COMPLETE NXR37 BLA	1	Nous consulter...	
999	S1722194	JAQUETTE COMPLETE NXR39 BLA	1	Nous consulter...	