

06/05/2004

2022-GeodisFioul-Tableau.xls

GEODIS 35-45 CVi/BVi (2004-->2009)

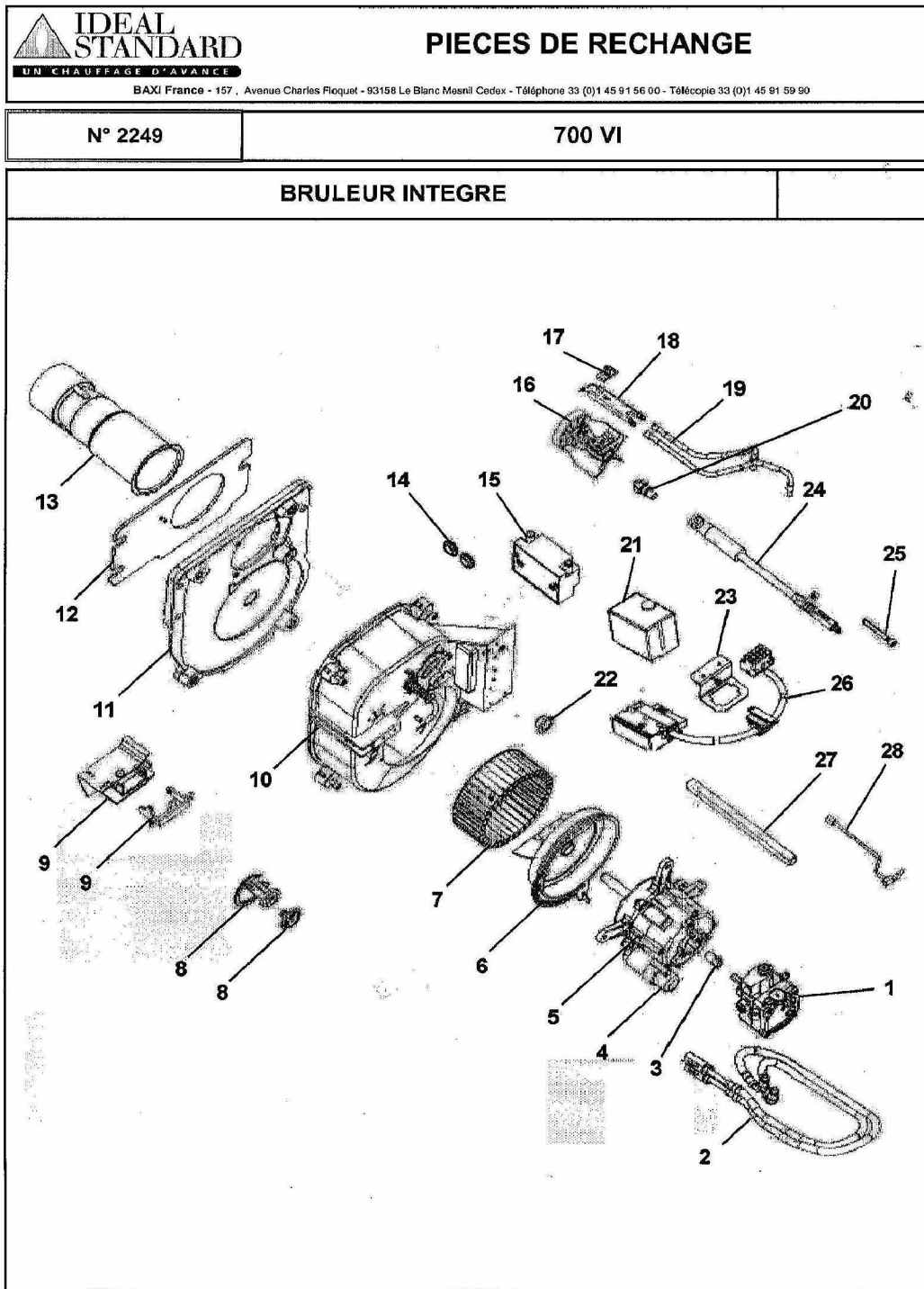



Réf.	Référenc	Description	Qté	Tarif	Substitut	Tarif Sub.	Remarques
47	S131691	TABLEAU COMMANDE EQUIP"GEO	1	Nous consulter...			⊘
60	S132367	CABLAGE TABLEAU IS	1	418,00 €			
61	S500226	SONDE EXTERIEURE AFS	1	83,10 €			
62	S500173	SONDE BALLON SPFS LG:2M	1				
63	S500174	SONDE CHAUDIERE KFS LG:1M	1				
64	S500389	SACHET VOYANTS+FUSIBLE/PORT	1	80,30 €			
64	S500389	SACHET VOYANTS+FUSIBLE/PORT	1	80,30 €			
64A	S1580359	FUSIBLE VERRE T4A D=5X20	1	3,50 €			
65	S500390	SACHET INTERRUPTEURS	1	97,70 €			
65	S500390	SACHET INTERRUPTEURS	1	97,70 €			
66	S500452	MODULE D'AMBIANCE SEUL IS	1				⊘
66A	S500393	EMBASE MODULE D'AMBIANCE	1	75,90 €			
66B	S500391	CARTE ELECTRONIQUE EQUIPEE	1	428,00 €			
67	S131939	COUVERCLE TABLEAU EQUIPEE IS	1	Nous consulter...			
68	S500453	ENS.ELECTRONIQUE CHAUDIERE	1	179,00 €			
69	S500454	PIECES PLASTIQUE+ FIX.IS	1	Nous consulter...			⊘
69	S500454	PIECES PLASTIQUE+ FIX.IS	1	Nous consulter...			⊘
70	S500397	ENS.THERMOSTAT DE REGULATIC	1	99,40 €			
70A	S1700473	MANETTE THERMOSTAT	1	3,70 €			
71	S132377	BEQUILLE	1	76,60 €			
72	S1700695	THERMOSTAT TG400 CAP.2M 971.	1	33,20 €			
73	S132344	FOND DE TABLEAU	1	106,00 €			
74	S1720210	SONDE DE DEPART VFAS	1	65,80 €			



07/05/2004

2249-IS-700VI.xls

GEODIS 35-45 CVi/BVi (2004-->2009)

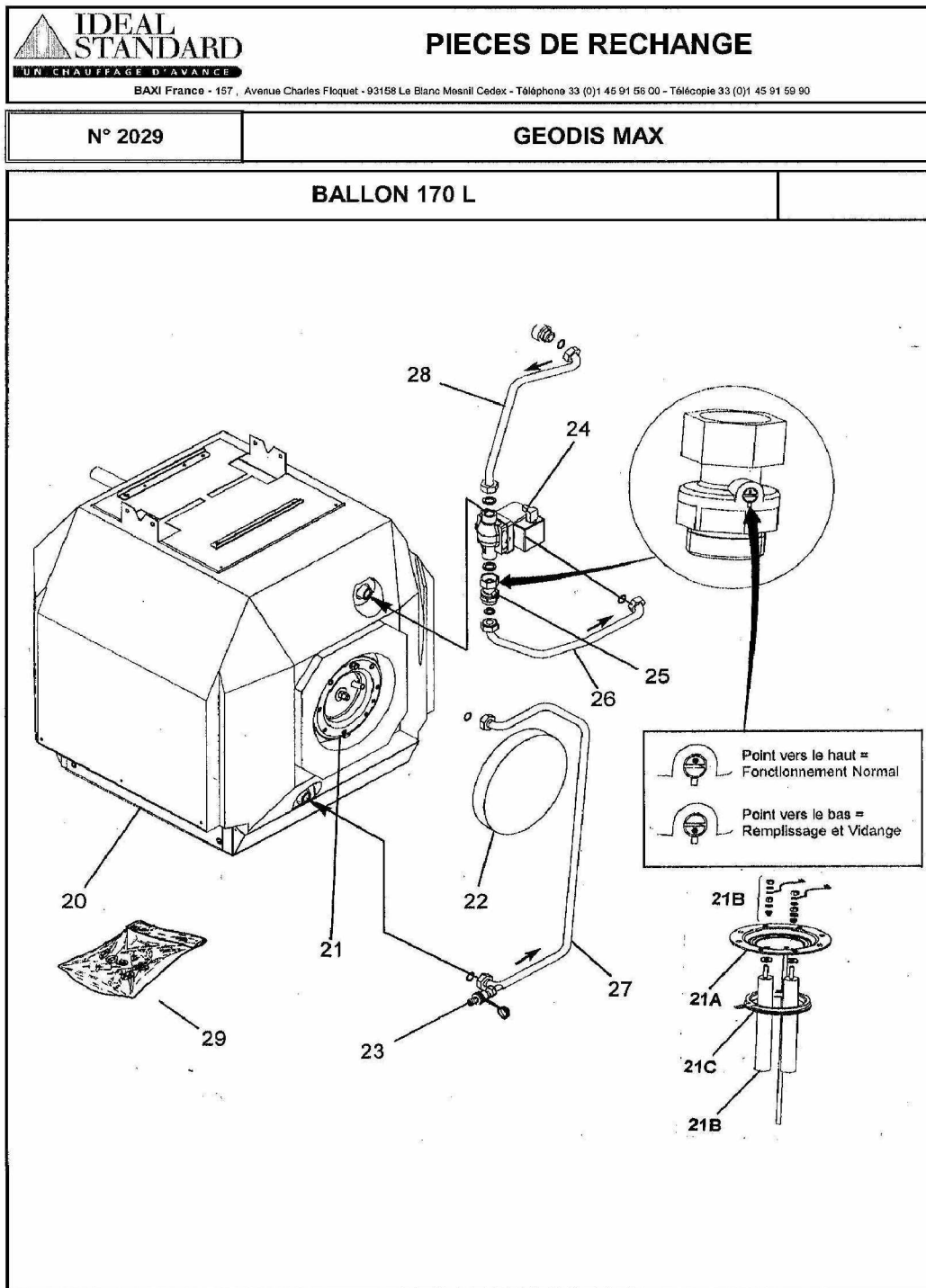

Réf.	Référenc	Description	Qté	Tarif	Substitut	Tarif Sub.	Remarques
0	S5853988	ENS.SOCLE SUM VENTOUSE	1	Nous consulter...			
1	S5832916	POMPE BFP31 L3 (071N1201)	1	135,00 €			
2	S5836663	FLEXIBLE MG1/4 90°-MG 1/4D 750	1	12,90 €			
3	S5840993	ACCOUPEMENT AEG 881 SAM4	1	6,60 €			
4	S5820986	CONDENSATEUR AEG	1	22,50 €			
5	S5808436	MOTEUR AEG COMPLET	1				
6	S5811938	OEILLARD BRULEUR EUROPEEN	1	11,20 €			
7	S5840995	TURBINE FERGAS KNA-E 133x52 R	1	18,60 €			
8	S5808436	ENS.BOUTON DE CLAPET	1	24,00 €			
8	S5808436	ENS.BOUTON DE CLAPET	1	24,00 €			
9	S5808413	ENS.CLAPET D'AIR	1	6,30 €			[To Translat =]
9	S5808413	ENS.CLAPET D'AIR	1	6,30 €			[To Translat =]
10	S5808412	VOLUTE ARRIERE	1	170,00 €			
11	S5808411	ENS.PLAQUE AVANT P/400I	1	196,00 €			
12	S5839010	JOINT DE PLAQUE FACADE	1	15,60 €			
13	S5811935	TUYERE BR61/77/82 BOL DE 52	1	164,00 €			
13	S5811939	TUYERE	1	42,60 €			
14	S5858999	PASSE FIL HT	1	1,05 €			
15	S5850424	TRANSFORMATEUR EBI DANFOSS	1	55,30 €			
16	S5808436	ENS.BOUTON DE CLAPET	1	24,00 €			
16	S5809000	S/E COUPELLE/CENTREUR BR.700	1	56,80 €			
17	S5808451	RESSORT ELECTRODES + VIS	1	38,00 €			
18	S5852843	BLOC D'ELECTRODES BR.500/700	1	9,10 €			
18	S5852842	BLOC ELECTRODE ALLUMAGE	1	34,00 €			
19	S5851849	FIL HAUTE TENSION EURO	1	19,40 €			
19	S5808379	FIL HT - 817 PENET. STANDARD	1	6,50 €			
20	S0031202	GICLEUR FLUIDICS 0,75G 60°SF	1	34,00 €			
20	S0031205	GICLEUR FLUIDICS 1,00G 60°SF	1	34,60 €			
21	S5853986	BLOC ACTIF MA55 D - 10M	1	198,00 €			
22	S5851851	BOUCHON KAPSTO - NON RECHAL	1	Nous consulter...			
23	S5814946	SUPPORT CONNECTEUR	1	Nous consulter...			
24	S5808493	LIGNE MONOBLOC 745Vi	1	76,50 €			
24	S5808379	LIGNE FIOUL NON RECHAUFFEE	1	92,40 €			
25	S5808379	ENS.VIS REGLAGE LIGNE+EPINGLI	1	44,50 €			
26	S5853992	ARAINNEE SUM MAX VENTOUSE	1	63,60 €			
27	S5880835	ENTRETOISE DE FIXATION CAPOT	1	Nous consulter...			
28	S5871667	TUBULURE POMPE LIGNE BR.700	1	17,60 €			



02/02/2005

2029-GeodisMax-Ballon.xls

GEODIS 35-45 CVi/BVi (2004-->2009)

Réf.	Référenc	Description	Qté	Tarif	Substitut	Tarif Sub.	Remarques
20	S137380	BALLON 170L SUM MAX	1				
21	S138100	ENS.CONTRE BRIDE EQUIPE 170L	1	153,00 €			
21A	S138101	CONTRE BRIDE SOUDEE 170L	1	67,60 €			
21B	S504018	ANODE+CABLE MASSE+GARNIT.17	1	79,80 €			
21B	S504018	ANODE+CABLE MASSE+GARNIT.17	1	79,80 €			
21C	S1563800	JOINT A LEVRE DN125	1	36,70 €			
22	S1700279	COUVERCLE MOUSSE PU R2/SUM	1	54,30 €			
23	S131960	TE DE VIDANGE 3/4"(130L)	1				
24	S136741	POMPE CP53 130 1" POS.4 AVEC C	1				
25	S132200	CLAPET ANTIRETOUR 1"M-1"F	1	16,50 €			
26	S138596	TUBE RACCORDEMENT POMPE BA	1	Nous consulter...			
26	S131541	FLEXIBLE COUDE 3/4"-COUDE 1"	1	46,90 €			
27	S139027	MODULE HYDRAULIQUE RETOUR	1	106,00 €			
27	S132275	FLEXIBLE COUDE-DROIT 3/4"	1				
28	S505411	TUBE POMPE + MAMELON + JOINT	1	71,10 €			
28	S131884	TUBULURE RAC POMPE 3/4"+ECRC	1				
29	S500401	POCHETTE JOINTS ENS.HYDRAUL	1				

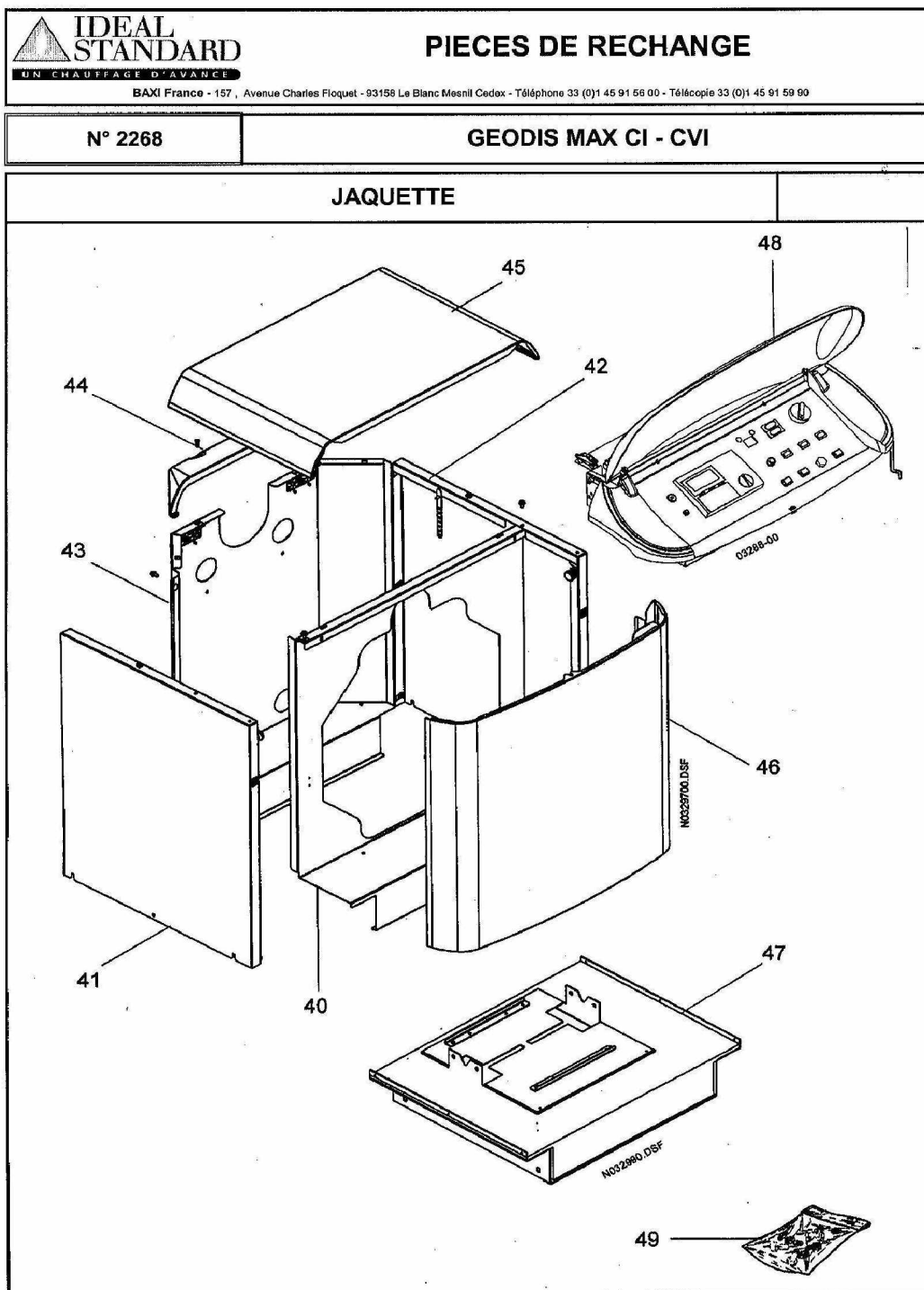

21/04/2004

2268-GeodMaxCICvi-Jaq



GODIS

GODIS 35-45 CVi/BVi (2004-->2009)

Réf.	Référenc	Description	Qté	Tarif	Substitut	Tarif Sub.	Remarques
40	S137359	FACADE INTERNE BI/CI EQUIPEE	1	Nous consulter...			
40	S137360	FACADE INTERNE VBI/VCI EQUIPEI	1	Nous consulter...			
41	S138293B	COTE GAUCHE PEINT EQUIPE C M.	1	Nous consulter...			
42	S138292B	COTE DROIT PEINT EQUIPE C MAX	1	Nous consulter...			
43	S132457B	TOLE ARRIERE EQUIPEE CVI 35KW	1	Nous consulter...			
43A	S138205B	TOLE ARRIERE CVI 45KW EQUIPEE	1	Nous consulter...			
44	S131558E	COIFFE ARRIERE NOIRE	1	152,00 €			
45	S137358B	DESSUS PEINT GODIS MAX	1	Nous consulter...			
46	S132453	FACADE EQUIPEE GODIS CI	1	Nous consulter...			
47	S137653	SOCLE CI EQUIPE	1	Nous consulter...			
48	S504420	TABLEAU GODIS CI	1	Nous consulter...			
49	S504664	SACHET VIS.JAQUETTE CI MAX	1	Nous consulter...			

 IDEAL STANDARD <small>UN CHAUFFAGE D'AVANCE</small>	PIECES DE RECHANGE
<small>BAXI France - 157, Avenue Charles Floquet - 93158 La Blanc Mesnil Cedex - Téléphone 33 (0)1 45 91 56 00 - Télécopie 33 (0)1 45 91 59 90</small>	

N° 2266	GEODIS MAX CVI - BVI
---------	----------------------



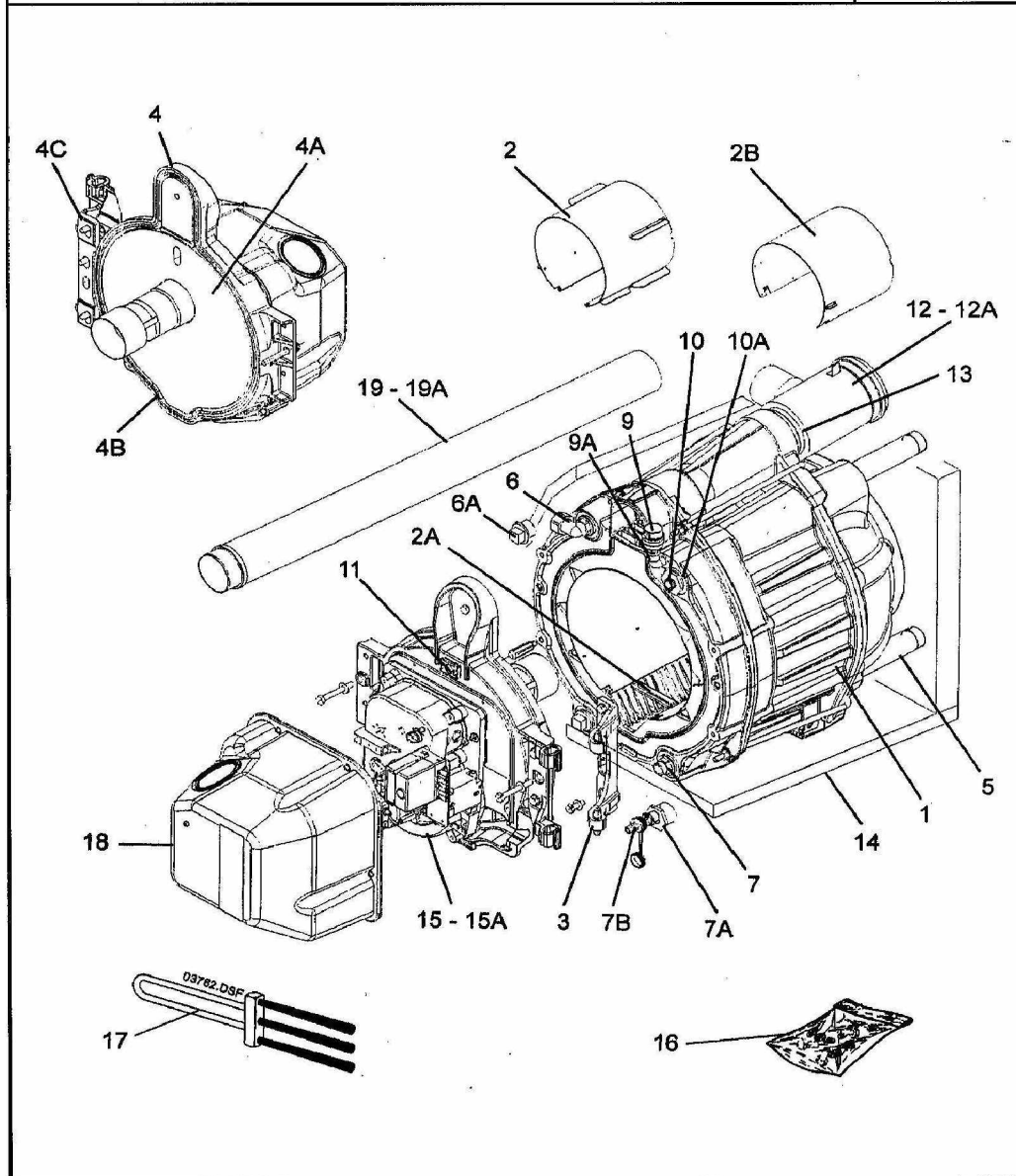











CORPS



21/04/2004

2266-GeodMaxCvIBvi-Corps

GEODIS 35-45 CVi/BVi (2004-->2009)

Réf.	Référence	Description	Qté	Tarif	Substitut	Tarif Sub.	Remarques
0	S1902003	KIT JOINTS POUR SUM MAX	1	219,00 €			KIT JOINT (joints D.42+ D.18+1 tres
1	S138314E	CORPS EQUIPE MAX CI CHEMINEE	1	1983,00 €			
1	S137241E	CORPS EQUIPE MAX BI	1	1983,00 €			
2	S136661	CANALISEUR 50KW ASSEMBLE	1	257,00 €			
2	S136661	CANALISEUR 50KW ASSEMBLE	1	257,00 €			
2	S137245	CANALISEUR 40KW ASSEMBLE	1	228,00 €			
2	S137245	CANALISEUR 40KW ASSEMBLE	1	228,00 €			
2A	S131557	ENTRETOISE DE VIROLE (BORA)	1				
3	S136956E	CHAPE PEINTE	1	Nous consulter...			
4	S137238	PORTE EQUIPEE SUM MAX	1	Nous consulter...			
4A	S137236	ISOLANT INTERNE DE PORTE	1	36,60 €			
4A	S137237	ISOLANT EXTERNE DE PORTE	1	72,10 €			
4A	S133467	ISOLANT SUPERIEUR	1				
4B	S1700019	TRESSE RONDE DE 16 (LE M) BLAN	1	19,20 €			
4C	S136957E	PAUMELLE DOUBLE PEINTE	1	36,00 €			
5	S131862	MANCHETTE EAU 1"1/4 M-M	1	Nous consulter...			
6	S131883	COUDE 1"1/4	1	120,00 €			
6A	SN912651	BOUCHON MALE NR.290-1"1/4	1	Nous consulter...			
7	S132178	MAMELON REDU.1"1/4M-3/4"M	1	95,60 €			
7A	S500350	MAMELON REDUIT NÂ°241 1"1/4-1/2	1	81,00 €			
7B	S1700647	ROBINET DE VIDANGE 1/2"	1	33,90 €			
8	SN912651	BOUCHON MALE NR.290-1"1/4	1	Nous consulter...			
9	S1700619	PURGEUR AUTOMATIQUE R88/13	1				
9A	S500149	COURBE MF NÂ°1A 3/8"	1	75,50 €			
10	SN911517	GAINÉ 1/2"NPT REF:555012	1	52,80 €			
10A	S1592420	REDUCTION GF241 1"X1/2"	1	Nous consulter...			
11	S1707614	ENS.OEILLETON	1	66,20 €			
12	S138192	MANCHETTE F.VENTOUSE 100/150	1	Nous consulter...			
12A	S137938	MANCHETTE FUMÉES VENT.80 LIS	1	Nous consulter...			
13	S1700016	TRESSE DE 7 SILICONEE (LE M)	1				
14	S132331	CALORIFUGE ARRIERE(CORPS SU	1	Nous consulter...			
14	S137297	CALORIFUGE LATERAL (SUM MAX)	1	Nous consulter...			
14	S137296	CALORIFUGE DESSOUS (SUM MAX)	1	Nous consulter...			
15	S5808939	BRULEUR INTEGRE "735VI"SUM M/	1	2095,00 €			 VOIR "REPLACE T BRULEUF INTEGRES"
15	S5808939	BRULEUR INTEGRE "745VI"SUM M/	1	Nous consulter...			 VOIR "REPLACE T BRULEUF INTEGRES"
16	S500406	SACHET VISSERIE	1	66,20 €			
17	S134243	BROSSE DE RAMONAGE (PINCEAL	1	60,80 €			
18	S138193	CAPOT EQUIPE SUM MAX	1				
19	S138307	ENS.GAINÉ AIR PAP.FIOU.MAX45(C	1	Nous consulter...			
19A	S138296	ENS.GAINÉ AIR PAP.FIOUL MAX 35	1	Nous consulter...			

PIECES DE RECHANGE <small>BAXI France - 157, Avenue Charles Floquet - 93158 La Blanc Mesnil Cedex - Téléphone 33 (0)1 45 91 56 00 - Télécopie 33 (0)1 45 91 59 90</small>		
N° 2260		
CONDUITS VENTOUSE		
<p>100</p> <p>Terminal horizontal réglable Ø 80/125 CFFVF0002 Ø 100/150 CFFVF0035</p>	<p>101 101A</p> <p>Terminal vertical 101 Ø 80/125 CFFVF0013 brique Ø 100/150 CFF0037 brique 101A Ø 80/125 CFFVF0015 noir Ø 100/150 CFFVF0038</p>	<p>102</p> <p>Coude à 45° Ø 80/125 CFFVF0006 Ø 100/150 CFFVF0043</p>
<p>103</p> <p>Coude à 90° Ø 80/125 CFFVF0005 Ø 100/150 CFFVF0042</p>	<p>104</p> <p>Récupérateur de condensats Ø 80/125 CFFVF0007 Ø 100/150 CFFVF0036</p>	<p>106</p> <p>Rallonge isolée de 0,5 m Ø 80/125 CFFVF0004 Ø 100/150 CFFVF0040</p>
<p>105</p> <p>Rallonge isolée de 1 m Ø 80/125 CFFVF0003 Ø 100/150 CFFVF0039</p>	<p>107</p> <p>Rallonge télescopique Ø 80/125 CFFVF0010 Ø 100/150 CFFVF0041</p>	<p>108 108A 108B 108C</p> <p>108 Solin tuile 10° à 30° base plomb Ø 80/125 CFFVF0011 Ø 100/150 CFFVF0045 108A Solin tuile 30° à 45° base plomb Ø 80/125 CFFVF0012 Ø 100/150 CFFVF0046 108B Solin ardoise 30° à 45° Ø 80/125 CFFVF0014 Ø 100/150 CFFVF0048 108C Solin toit plat Ø 80/125 CFFVF0050 Ø 100/150 CFFVF0047</p>
<p>110</p> <p>Filtre acoustique Ø 80/125 CFFVF0008 Ø 100/150 CFFVF 0049</p>	<p>109</p> <p>Grille de protection Ø 80/125 CFFVF0009 Ø 100/150 CFFVF0044</p>	<p>111</p> <p>Sachet joints : 2 x 80 + 2 x 125 2 x 100 + 2 x 150</p>



GEODIS

GEODIS 35-45 CVi/BVi (2004-->2009)



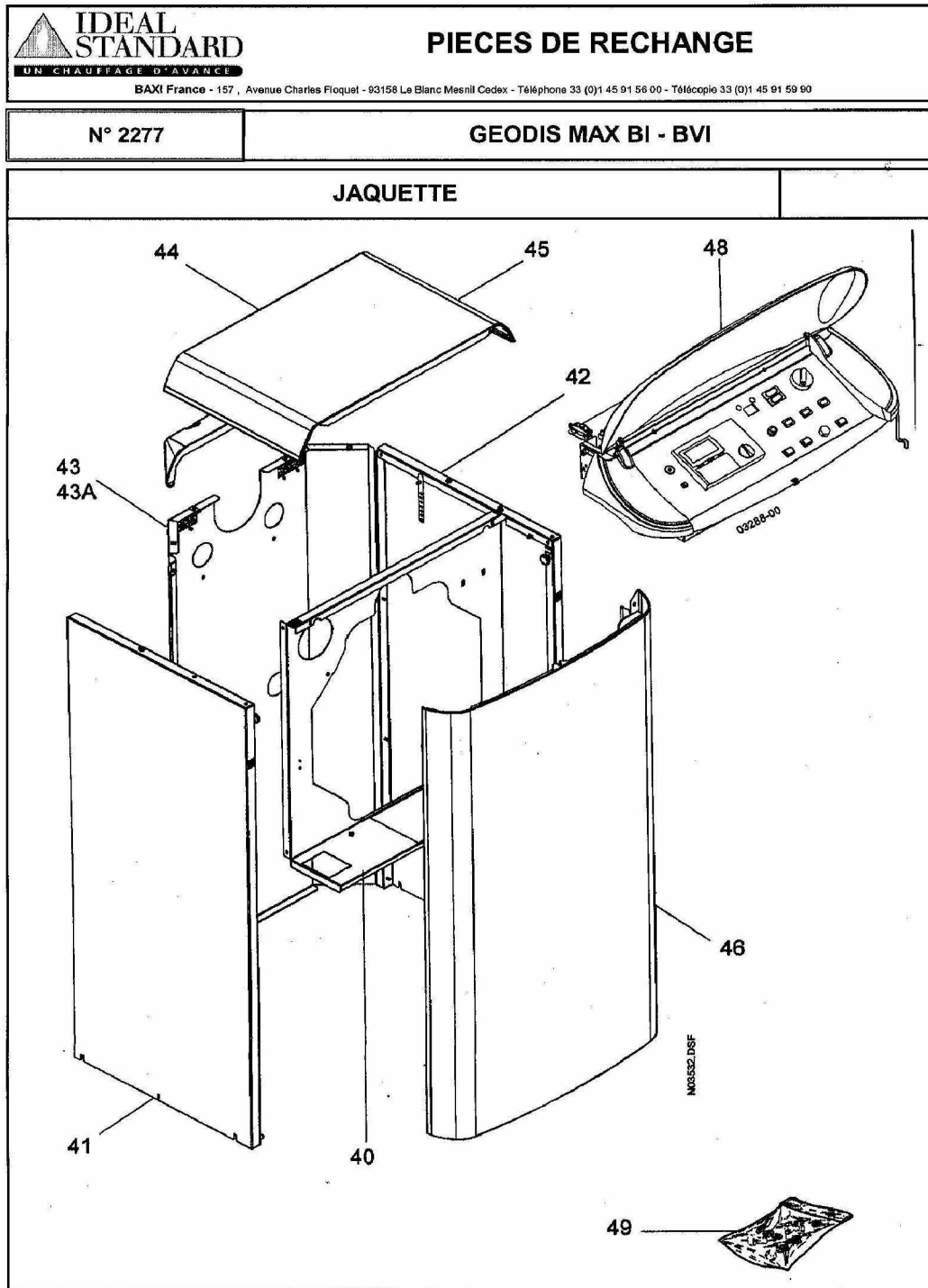





Réf.	Référenc	Description	Qté	Tarif	Substitut	Tarif Sub.	Remarques
111	S501093	SACHET JOINTS CONDUITS VENTC	1	63,80 €			
111	S504674	SACHET JOINTS CONDUIT VENT.4€	1	87,50 €			



21/04/2004

2277-GeodMaxBiBvi-Jaq

GEODIS 35-45 CVi/BVi (2004-->2009)

Réf.	Référenc	Description	Qté	Tarif	Substitut	Tarif Sub.	Remarques
40	S137359	FACADE INTERNE BI/CI EQUIPEE	1	Nous consulter...			
40	S137360	FACADE INTERNE VBI/VCI EQUIPEI	1	Nous consulter...			
41	S137362B	COTE GAUCHE PEINT EQUIP.BI MA	1	Nous consulter...			
42	S137361B	COTE DROIT PEINT EQUIP.BI MAX	1	Nous consulter...			
43	S132235B	TOLE ARRIERE EQUIPEE GEODIS E	1	Nous consulter...			
43A	S138287B	TOLE ARRIERE BVI 45KW EQUIPEE	1	Nous consulter...			
44	S131558E	COIFFE ARRIERE NOIRE	1	152,00 €			
45	S137358B	DESSUS PEINT GEODIS MAX	1	Nous consulter...			
46	S132231	FACADE EQUIPEE GEODIS BI	1	Nous consulter...			
48	S137659	TABLEAU GEODIS BI	1	Nous consulter...			
49	S504665	SACHET VIS.JAQUETTE BI MAX	1	Nous consulter...			