

1606

TABLEAU DE COMMANDE VERSION "B"

IDEAL 2400 - R4

| Réf. | Référenc | Description | Qté | Tarif | Substitut | Tarif Sub. | Remarques |
|------|----------|------------------------------|-----|-------------------|-----------|------------|-----------|
| 80 | S1720247 | TABLEAU COMMANDE CABLE "B" | 1 | Nous consulter... | | | ⊘ |
| 81 | S1583826 | VOYANT LS 5 K ROUGE D=12 | 1 | Nous consulter... | | | ⊘ |
| 82 | S1583826 | VOYANT LS 5 A B5 ORANGE D=12 | 1 | Nous consulter... | | | ⊘ |
| 83 | S1580399 | PORTE FUSIBLE | 1 | | | | |
| 84 | S1580352 | FUSIBLE 6.3 AMPERES 5X20 | 1 | 6,80 € | | | |
| 85 | S1700699 | THERMOSTAT RAK 51.41.71 | 1 | | | | |
| 86 | S1700473 | MANETTE THERMOSTAT | 1 | 3,70 € | | | |
| 87 | S1700694 | THERMOSTAT RAK 77.44.71 | 1 | 33,20 € | | | |
| 88 | S1700706 | THERMOMETRE RECT.20Â°A120Â° | 1 | 18,30 € | | | |
| 89 | S1700228 | CACHE THERMOMETRE | 1 | 1,65 € | | | ⊘ |
| 90 | S1700695 | THERMOMETRE FUMÉES RECTAN | 1 | Nous consulter... | | | ⊘ |
| 91 | S1580408 | INTERRUPTEUR DOUBLE TEST | 1 | Nous consulter... | | | ⊘ |
| 92 | S1707718 | CABLE BRULEUR 1 ALLURE | 1 | 213,00 € | | | |
| 93 | S1707718 | CABLE BRULEUR 2EME ALLURE | 1 | 109,00 € | | | |
| 94 | S1700229 | COTE GAUCHE BANDEAU"B" | 1 | Nous consulter... | | | ⊘ |
| 94 | S1700229 | COTE GAUCHE BANDEAU"B" | 1 | Nous consulter... | | | ⊘ |
| 94 | S1700228 | COTE DROIT BANDEAU"B" | 1 | Nous consulter... | | | ⊘ |
| 94 | S1700228 | COTE DROIT BANDEAU"B" | 1 | Nous consulter... | | | ⊘ |
| 95 | S1788016 | SACHET ACCES.ET VIS BANDEAU" | 1 | Nous consulter... | | | ⊘ |

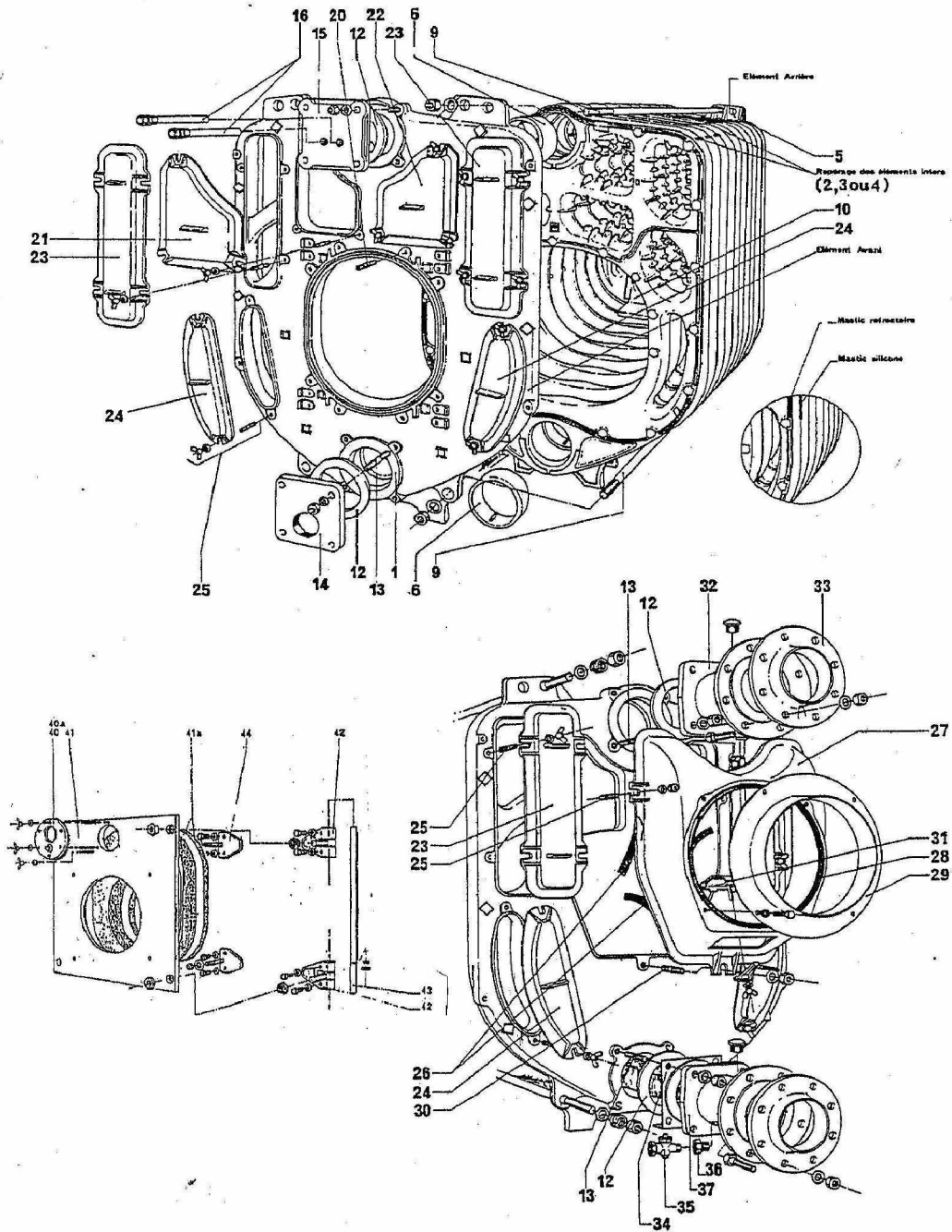

1622 CORPS CHAUDIERE IDEAL 2400

IDEAL 2400 - R4

| Réf. | Référence | Description | Qté | Tarif | Substitut | Tarif Sub. | Remarques |
|------|-----------|--------------------------------|-----|-------------------|-----------|------------|-----------|
| 1 | S1780177 | ELEMENT AVANT NXR4 | 1 | Nous consulter... | | | ⊘ |
| -1 | S1990022 | BOITE MASTIC DE 1 KGS | 1 | Nous consulter... | | | ⊘ |
| -1 | S1700477 | MASTIC BOITE DE 0,800 KG | 1 | Nous consulter... | | | ⊘ |
| -1 | S1700208 | GEBSICONE 902 (310 ML) | 1 | 24,20 € | | | ⊘ |
| 2 | S1780600 | ELEMENT INTER AVANT NXR4 | 1 | Nous consulter... | | | ⊘ |
| 3 | S1780346 | ELEMENT INTER.MILIEU MALAGA 4 | 1 | Nous consulter... | | | ⊘ |
| 4 | S1780641 | ELEMENT INTER.ARRIERE MALAG/ | 1 | 3217,00 € | | | |
| 5 | S1780243 | ELEMENT ARRIERE MALAGA 4 | 1 | 2994,00 € | | | |
| 6 | S1780950 | NIPPLE D=140 | 1 | | | | |
| 6 | S1780950 | NIPPLE D=140 | 1 | | | | |
| 9 | S1707734 | TRINGL.ASS.CHAUD.SERIE 400 17€ | 1 | Nous consulter... | | | ⊘ |
| 9 | S1707734 | TRINGL.ASS.CHAUD.SERIE 400 17€ | 1 | Nous consulter... | | | ⊘ |
| 9 | S1707734 | TRINGL.ASS.CHAUD.SERIE 400 16€ | 1 | Nous consulter... | | | ⊘ |
| 9 | S1707734 | TRINGL.ASS.CHAUD.SERIE 400 16€ | 1 | Nous consulter... | | | ⊘ |
| 9 | S1707734 | TRINGL.ASS.CHAUD.SERIE 400 14€ | 1 | Nous consulter... | | | ⊘ |
| 9 | S1707734 | TRINGL.ASS.CHAUD.SERIE 400 14€ | 1 | Nous consulter... | | | ⊘ |
| 9 | S1707734 | TRINGL.ASS.CHAUD.SERIE 400 12€ | 1 | Nous consulter... | | | ⊘ |
| 9 | S1707734 | TRINGL.ASS.CHAUD.SERIE 400 12€ | 1 | Nous consulter... | | | ⊘ |
| 9 | S1707734 | TRINGL.ASS.CHAUD.SERIE 400 9S | 1 | Nous consulter... | | | ⊘ |
| 9 | S1707734 | TRINGL.ASS.CHAUD.SERIE 400 9S | 1 | Nous consulter... | | | ⊘ |
| 9 | S1707734 | TRINGL.ASS.CHAUD.SERIE 400 10€ | 1 | Nous consulter... | | | ⊘ |
| 9 | S1707734 | TRINGL.ASS.CHAUD.SERIE 400 10€ | 1 | Nous consulter... | | | ⊘ |
| 9 | S1707734 | TRINGL.ASS.CHAUD.SERIE 400 13€ | 1 | Nous consulter... | | | ⊘ |
| 9 | S1707734 | TRINGL.ASS.CHAUD.SERIE 400 13€ | 1 | Nous consulter... | | | ⊘ |
| 9 | S1707734 | TRINGL.ASS.CHAUD.SERIE 400 11€ | 1 | Nous consulter... | | | ⊘ |
| 9 | S1707734 | TRINGL.ASS.CHAUD.SERIE 400 11€ | 1 | Nous consulter... | | | ⊘ |
| 9 | S1707734 | TRINGL.ASS.CHAUD.SERIE 400 15€ | 1 | Nous consulter... | | | ⊘ |
| 9 | S1707734 | TRINGL.ASS.CHAUD.SERIE 400 15€ | 1 | Nous consulter... | | | ⊘ |
| 10 | S1700598 | PLAQUE PROTECTION CM3P | 1 | Nous consulter... | | | ⊘ |
| 11 | S1700070 | BRIDE PLEINE CARREE 190X190 | 1 | Nous consulter... | | | ⊘ |
| 12 | S1560130 | JOINT BRIDE A5-A6 130X170 | 1 | 41,40 € | | | |
| 12 | S1560130 | JOINT BRIDE A5-A6 130X170 | 1 | 41,40 € | | | |
| 12 | S1560130 | JOINT BRIDE A5-A6 130X170 | 1 | 41,40 € | | | |
| 12 | S1560130 | JOINT BRIDE A5-A6 130X170 | 1 | 41,40 € | | | |
| 13 | S1524372 | GOUJON ACIER DIA 16 LG 66 | 1 | 9,00 € | | | |
| 13 | S1524372 | GOUJON ACIER DIA 16 LG 66 | 1 | 9,00 € | | | |
| 13 | S1524372 | GOUJON ACIER DIA 16 LG 66 | 1 | 9,00 € | | | |
| 14 | S1700070 | BRIDE CHASSE BOUE SERIE 4A6 | 1 | 401,00 € | | | |
| 14 | S1700070 | C/BRIDE ACIER ALESEE O90 MG5/€ | 1 | Nous consulter... | | | ⊘ |
| 15 | S1786258 | BRIDE CARREE TARAUDEE | 1 | | | | |
| 16 | S1700177 | GAINÉ 120 MM 15X21 | 1 | Nous consulter... | | | ⊘ |
| 21 | S1784341 | TAMP.RAM.CENTR.G.CPLT MAL.4 | 1 | Nous consulter... | | | ⊘ |
| 22 | S1784340 | TAMP.RAM.CENTR.D.CPLT MAL.4 | 1 | Nous consulter... | | | ⊘ |
| 23 | S1784342 | TAMP.RAM.LAT.SUP.CPLT MAL.4 | 1 | Nous consulter... | | | ⊘ |
| 23 | S1784342 | TAMP.RAM.LAT.SUP.CPLT MAL.4 | 1 | Nous consulter... | | | ⊘ |
| 23 | S1784342 | TAMP.RAM.LAT.SUP.CPLT MAL.4 | 1 | Nous consulter... | | | ⊘ |
| 24 | S1784343 | TAMPON RAMONAGE INF.D/G CM4 | 1 | Nous consulter... | | | ⊘ |
| 24 | S1784343 | TAMPON RAMONAGE INF.D/G CM4 | 1 | Nous consulter... | | | ⊘ |
| 24 | S1784343 | TAMPON RAMONAGE INF.D/G CM4 | 1 | Nous consulter... | | | ⊘ |

IDEAL 2400 - R4

| | | | | | |
|-----|----------|--------------------------------|---|-------------------|---|
| 25 | S1524351 | GOUJON 8X45 | 1 | 37,90 € | |
| 25 | S1524351 | GOUJON 8X45 | 1 | 37,90 € | |
| 25 | S1524351 | GOUJON 8X45 | 1 | 37,90 € | |
| 26 | S1700019 | TRESSE 15X6 BUSE CM3 | 1 | Nous consulter... | ⊘ |
| 26 | S1700019 | TRESSE CERAMIQ.15X6 D:12(2M) | 1 | 42,70 € | |
| 27 | S1785046 | BOITE A FUMEEES MALAGA 408A41' | 1 | Nous consulter... | |
| 27 | S1785045 | BOITE FUMEEES MAL.4/IT400 | 1 | Nous consulter... | ⊘ |
| 28 | S1700017 | TRESSE CARRE 9 CM3 LE M | 1 | Nous consulter... | ⊘ |
| 29 | S1700111 | COLLERET.REDUCT.350 MAL.4 | 1 | Nous consulter... | ⊘ |
| 29 | S1700111 | COLLERETTE REDUCT.300 MALAG | 1 | Nous consulter... | ⊘ |
| 30 | S1707216 | GOUJON 16X55 | 1 | Nous consulter... | ⊘ |
| 30 | S1524372 | GOUJON ACIER DIA 16 LG 66 | 1 | 9,00 € | |
| 31 | S1785530 | TAMPON B.F ASS CM3P | 1 | Nous consulter... | ⊘ |
| 32 | S1786524 | MANCHETTE DEPART MAL.4/IT400 | 1 | Nous consulter... | ⊘ |
| 33 | S1700076 | BRID.RACORD DEPART RET.MAL.4 | 1 | Nous consulter... | ⊘ |
| 34 | S1700654 | REPARTITEUR XR412/414 | 1 | 385,00 € | |
| 34 | S1700653 | REPARTITEUR NXR4/2400 415/417 | 1 | Nous consulter... | ⊘ |
| 35 | S1700101 | CLE DE ROBINET VIDANGE | 1 | Nous consulter... | ⊘ |
| 35 | S1700647 | ROBINET VIDANGE 20X27 | 1 | 35,20 € | |
| 36 | S1786912 | REDUCTION 50X20 | 1 | Nous consulter... | ⊘ |
| 37 | S1786525 | MANCHETTE RETOUR MALAGA 4 | 1 | Nous consulter... | ⊘ |
| 38 | SA002101 | MANCH.ECOUV.1150D=10 TIG.TOR | 1 | Nous consulter... | ⊘ |
| 38 | S1707626 | RINGARD 1M50 48700 CM3 | 1 | Nous consulter... | ⊘ |
| 38 | S1700082 | BROS.ECOUVIL.COUEEE 40 | 1 | Nous consulter... | ⊘ |
| 38 | S1700631 | RACCORD ECOUVILLON P258 CM3 | 1 | Nous consulter... | ⊘ |
| 38 | S1707626 | PIQUE FEU CM3P LONG 1M000 | 1 | Nous consulter... | ⊘ |
| 38 | S1700201 | ECOUVILLON LG 100 CM3 | 1 | Nous consulter... | ⊘ |
| 38 | S1707626 | RINGARD 2M 48699 CM3 | 1 | Nous consulter... | ⊘ |
| 39 | S1788045 | SACHET VIS.CORPS MALAGA 4 | 1 | Nous consulter... | ⊘ |
| 40 | S1783442 | HUBLOT CIRCULAIRE ASSEMBLE | 1 | 211,00 € | |
| 40A | S1700778 | VOYANT PYREX MALAGA 4 | 1 | | |
| 41 | S1700598 | PLAQUE FOYER MOBILE MALAGA 4 | 1 | Nous consulter... | ⊘ |
| 41A | S1740541 | KIT CALOR.PORTE FOYER XR4 | 1 | 138,00 € | |
| 42 | S1783341 | ARTICULATION PORTE D/G MAL.4 | 1 | Nous consulter... | ⊘ |
| 42 | S1783341 | ARTICULATION PORTE D/G MAL.4 | 1 | Nous consulter... | ⊘ |
| 43 | S1707029 | AXE PORTE MALAGA 4 | 1 | Nous consulter... | ⊘ |
| 44 | S1707165 | FERMETURE PORTE CPLT MALAG | 1 | Nous consulter... | ⊘ |
| 45 | S1788046 | SACHET VIS.PORTE MALAGA 4 | 1 | Nous consulter... | ⊘ |

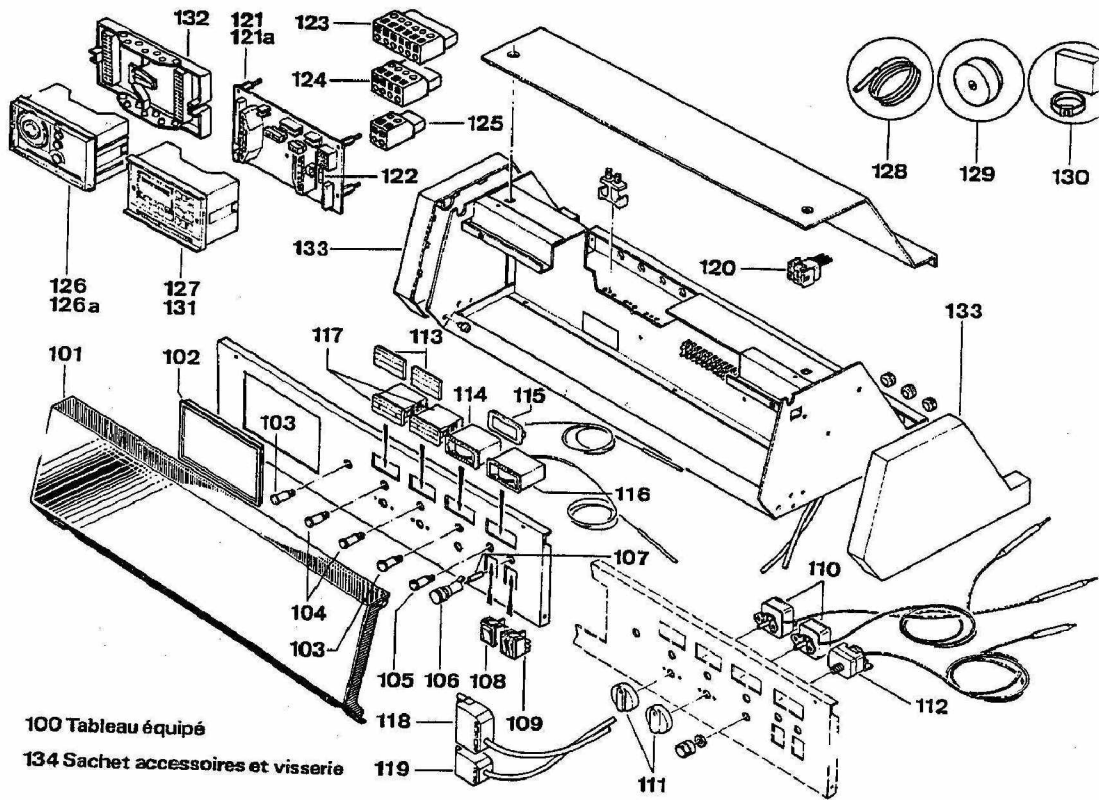

1607

TABEAU DE COMMANDE VERSION "R"

IDEAL 2400 - R4

| Réf. | Référenc | Description | Qté | Tarif | Substitut | Tarif Sub. | Remarques |
|------|----------|-------------------------------|-----|-------------------|-----------|------------|-----------|
| -1 | S1793768 | DESSUS TABLEAU R3 JAUNE | 1 | Nous consulter... | | | ⊘ |
| -1 | S1793767 | FACADE TABLEAU COMMANDE R3 | 1 | Nous consulter... | | | ⊘ |
| -1 | S1793764 | FOND DE TABLEAU R3 | 1 | Nous consulter... | | | ⊘ |
| 100 | S1720247 | BANDEAU CABLE "R" | 1 | Nous consulter... | | | ⊘ |
| 101 | S1700385 | ECRAN DE PROTECTION | 1 | Nous consulter... | | | ⊘ |
| 102 | S1700559 | PLATINE D'OBTURATION | 1 | 14,70 € | | | |
| 103 | S1583826 | VOYANT LS 5 K ROUGE D=12 | 1 | Nous consulter... | | | ⊘ |
| 104 | S1583826 | VOYANT VERT D=12 | 1 | Nous consulter... | | | ⊘ |
| 105 | S1583826 | VOYANT LS 5 A B5 ORANGE D=12 | 1 | Nous consulter... | | | ⊘ |
| 106 | S1580399 | PORTE FUSIBLE | 1 | | | | |
| 107 | S1580352 | FUSIBLE 6.3 AMPERES 5X20 | 1 | 6,80 € | | | |
| 108 | S1580402 | INTERRUPTEUR 300 B5 NN | 1 | Nous consulter... | | | ⊘ |
| 109 | S1580408 | INTERRUPTEUR DOUBLE TEST | 1 | Nous consulter... | | | ⊘ |
| 110 | S1700699 | THERMOSTAT RAK 51.41.71 | 1 | | | | |
| 111 | S1700473 | MANETTE THERMOSTAT | 1 | 3,70 € | | | |
| 112 | S1700694 | THERMOSTAT RAK 77.44.71 | 1 | 33,20 € | | | |
| 113 | S1700226 | CACHE COMPTEUR | 1 | Nous consulter... | | | ⊘ |
| 114 | S1700706 | THERMOMETRE RECT.20Ã°A120Ã° | 1 | 18,30 € | | | |
| 115 | S1700228 | CACHE THERMOMETRE | 1 | 1,65 € | | | ⊘ |
| 116 | S1700695 | THERMOMETRE FUMEEES RECTAN | 1 | Nous consulter... | | | ⊘ |
| 117 | S1700121 | COMPTEUR HORAIRE FWZ | 1 | Nous consulter... | | | ⊘ |
| 118 | S1707718 | CABLE BRULEUR 1 ALLURE | 1 | 213,00 € | | | |
| 119 | S1707718 | CABLE BRULEUR 2EME ALLURE | 1 | 109,00 € | | | |
| 120 | S1707075 | CONNECTEUR RACCORD T/B | 1 | Nous consulter... | | | ⊘ |
| 120 | S1707075 | CONNECTEUR DE REGUL.AVEC C/ | 1 | 18,60 € | | | |
| 121 | S1707064 | CIRCUIT IMPRIME CI.1004 | 1 | Nous consulter... | | | ⊘ |
| 121A | S1707064 | CIRCUIT IMPRIME CI.21004 | 1 | Nous consulter... | | | ⊘ |
| 122 | S1580359 | FUSIBLE VERRE T4A D=5X20 | 1 | 3,50 € | | | |
| 123 | S1580263 | CONNECTEUR 6V.WAGO 231.306 | 1 | Nous consulter... | | | ⊘ |
| 124 | S1580262 | CONNECTEUR 4VOIES WAGO 231. | 1 | Nous consulter... | | | ⊘ |
| 125 | S1580263 | CONNECTEUR 2VOIES WAGO 231. | 1 | 18,60 € | | | |
| 126 | S1700635 | REGULATEUR RVP41.100 (RA1010) | 1 | Nous consulter... | | | ⊘ |
| 127 | S1700624 | REGULAT.RVP75.230/1009(RD3032 | 1 | Nous consulter... | | | ⊘ |
| 128 | S1720211 | SONDE CHAUDIERE QAZ21 2M | 1 | | | | |
| 129 | S1720211 | SONDE EXTERIEURE QAC 31 | 1 | Nous consulter... | | | ⊘ |
| 130 | S1720211 | SONDE DE DEPART QAD 21 | 1 | Nous consulter... | | | ⊘ |
| 130 | S1700681 | SONDE DEPART QAD21 (GP:1 | 1 | 81,20 € | | | |
| 131 | S1700624 | REGULAT.RVP45.500/1009(RD1011 | 1 | Nous consulter... | | | ⊘ |
| 132 | S1700678 | SOCLE AGS 90.2 | 1 | Nous consulter... | | | ⊘ |
| 133 | S1700228 | COTE DROIT BANDEAU"B" | 1 | Nous consulter... | | | ⊘ |
| 133 | S1700229 | COTE GAUCHE BANDEAU"B" | 1 | Nous consulter... | | | ⊘ |
| 134 | S1788034 | SACHET ACCES.ET VIS BANDEAU" | 1 | Nous consulter... | | | ⊘ |

| | |
|--|---------------------------|
|  IDEAL STANDARD <small>UN CHAUFFAGE D'AVANCE</small> | PIECES DE RECHANGE |
| <small>BAXI France - 157, Avenue Charles Floquet - 93158 Le Blanc Mesnil Cedex - Téléphone 33 (0)1 45 91 56 00 - Télécopie 33 (0)1 45 91 59 90</small> | |

| | |
|----------------|-------------|
| N° 1623 | 2400 |
|----------------|-------------|

JAQUETTE

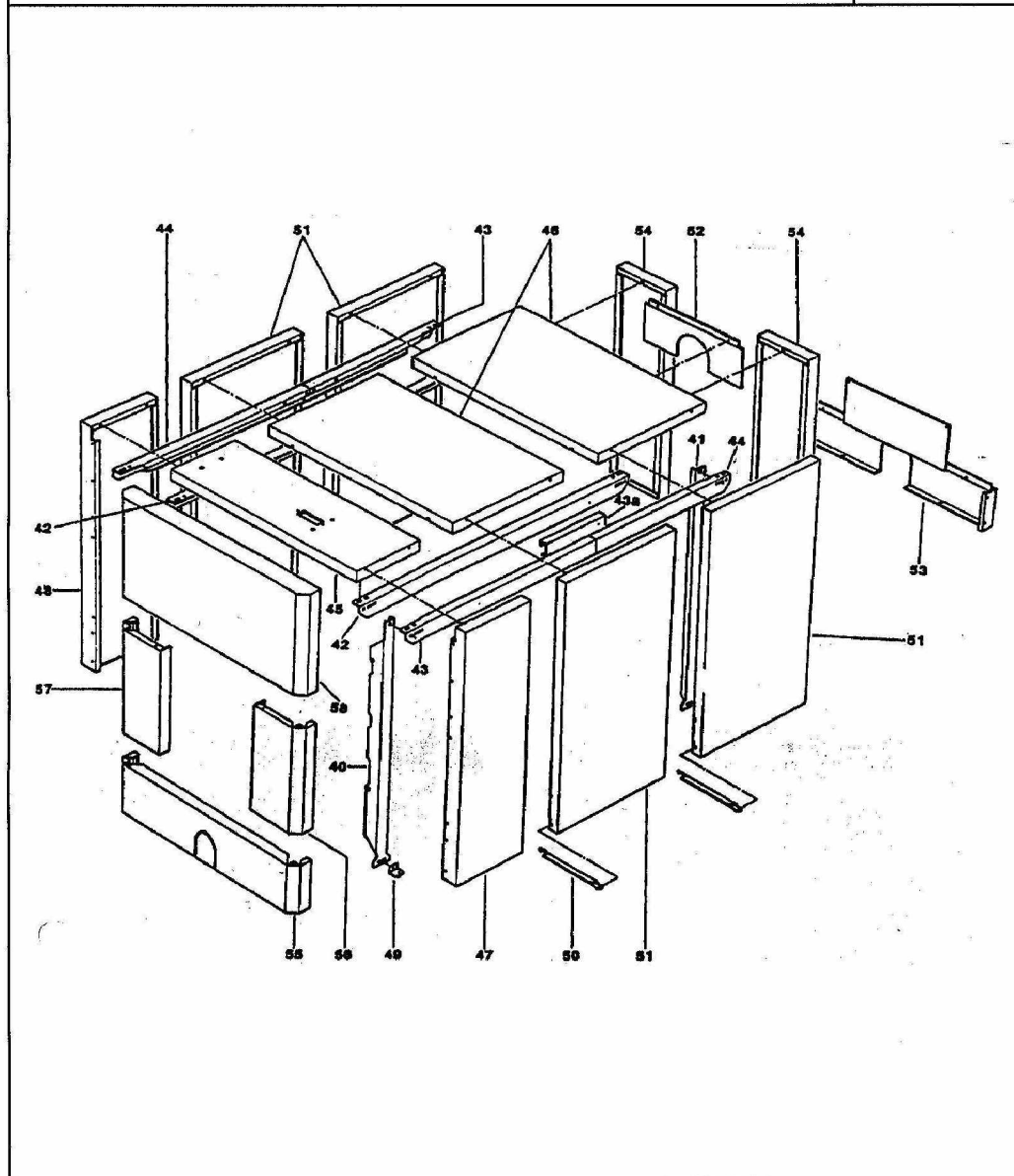















































17/01/2005

1623-2400-JAQUETTE.xls

IDEAL 2400 - R4

| Réf. | Référence | Description | Qté | Tarif | Substitut | Tarif Sub. | Remarques |
|------|-----------|------------------------------|-----|-------------------|-----------|------------|-----------|
| -1 | S1724521 | COMPLEMENT JAQUETTE 2417 | 1 | Nous consulter... | | | ⊘ |
| -1 | S1724711 | COMPLEMENT JAQUETTE R4 415 E | 1 | Nous consulter... | | | ⊘ |
| -1 | S1724521 | COMPLEMENT JAQUETTE 2415 | 1 | Nous consulter... | | | ⊘ |
| -1 | S1724711 | COMPLEMENT JAQUETTE R4 417 E | 1 | Nous consulter... | | | ⊘ |
| -1 | S1724521 | COMPLEMENT JAQUETTE 2416 | 1 | Nous consulter... | | | ⊘ |
| -1 | S1724521 | COMPLEMENT JAQUETTE 2411 | 1 | Nous consulter... | | | ⊘ |
| -1 | S1724520 | COMPLEMENT JAQUETTE 2409 | 1 | Nous consulter... | | | ⊘ |
| -1 | S1724711 | COMPLEMENT JAQUETTE R4 413 E | 1 | Nous consulter... | | | ⊘ |
| -1 | S1724521 | COMPLEMENT JAQUETTE 2414 | 1 | Nous consulter... | | | ⊘ |
| -1 | S1724710 | COMPLEMENT JAQUETTE XR4 409 | 1 | Nous consulter... | | | ⊘ |
| -1 | S1724711 | COMPLEMENT JAQUETTE R4 416 E | 1 | Nous consulter... | | | ⊘ |
| -1 | S1724521 | COMPLEMENT JAQUETTE 2410 | 1 | Nous consulter... | | | ⊘ |
| -1 | S1724521 | COMPLEMENT JAQUETTE 2412 | 1 | Nous consulter... | | | ⊘ |
| -1 | S1724711 | COMPLEMENT JAQUETTE R4 414 E | 1 | Nous consulter... | | | ⊘ |
| -1 | S1724711 | COMPLEMENT JAQUETTE R4 410 E | 1 | Nous consulter... | | | ⊘ |
| -1 | S1724711 | COMPLEMENT JAQUETTE R4 411 E | 1 | Nous consulter... | | | ⊘ |
| -1 | S1724711 | COMPLEMENT JAQUETTE R4 412 E | 1 | Nous consulter... | | | ⊘ |
| -1 | S1724510 | JAQUETTE COMMUNE ID.2400 | 1 | Nous consulter... | | | ⊘ |
| -1 | S1724521 | COMPLEMENT JAQUETTE 2413 | 1 | Nous consulter... | | | ⊘ |
| -1 | S504976 | LOGO CLIPS IS | 1 | Nous consulter... | | | ⊘ |
| -1 | S1724710 | JAQUETTE COMMUNE R4 BLANCH | 1 | Nous consulter... | | | ⊘ |
| 40 | S1794041 | MONTANT AV.DROIT ET AR.GAUCH | 1 | Nous consulter... | | | ⊘ |
| 41 | S1794041 | MONTANT AV.GAUCHE ET AR.DRO | 1 | Nous consulter... | | | ⊘ |
| 42 | S1794043 | LONGERON MOD.410 | 1 | Nous consulter... | | | ⊘ |
| 42 | S1794043 | LONGERON MOD.410 | 1 | Nous consulter... | | | ⊘ |
| 42 | S1794044 | LONGERON MOD.411 | 1 | Nous consulter... | | | ⊘ |
| 42 | S1794044 | LONGERON MOD.411 | 1 | Nous consulter... | | | ⊘ |
| 42 | S1794042 | LONGERON MOD.409 | 1 | Nous consulter... | | | ⊘ |
| 42 | S1794042 | LONGERON MOD.409 | 1 | Nous consulter... | | | ⊘ |
| 43 | S1794047 | DEMI LONGERON COMMUN 412 A | 1 | Nous consulter... | | | ⊘ |
| 43A | S1794072 | ECLISSE | 1 | Nous consulter... | | | ⊘ |
| 44 | S1794050 | DEMI LONGERON MOD.417 | 1 | Nous consulter... | | | ⊘ |
| 44 | S1794050 | DEMI LONGERON MOD.417 | 1 | Nous consulter... | | | ⊘ |
| 44 | S1794045 | DEMI LONGERON MOD.412 | 1 | Nous consulter... | | | ⊘ |
| 44 | S1794045 | DEMI LONGERON MOD.412 | 1 | Nous consulter... | | | ⊘ |
| 44 | S1794047 | DEMI LONGERON MOD.414 | 1 | Nous consulter... | | | ⊘ |
| 44 | S1794047 | DEMI LONGERON MOD.414 | 1 | Nous consulter... | | | ⊘ |
| 44 | S1794048 | DEMI LONGERON MOD.415 | 1 | Nous consulter... | | | ⊘ |
| 44 | S1794048 | DEMI LONGERON MOD.415 | 1 | Nous consulter... | | | ⊘ |
| 44 | S1794046 | DEMI LONGERON MOD.413 | 1 | Nous consulter... | | | ⊘ |
| 44 | S1794046 | DEMI LONGERON MOD.413 | 1 | Nous consulter... | | | ⊘ |
| 44 | S1794049 | DEMI LONGERON MOD.416 | 1 | Nous consulter... | | | ⊘ |
| 44 | S1794049 | DEMI LONGERON MOD.416 | 1 | Nous consulter... | | | ⊘ |
| 45 | S1794051 | PANNEAU DESSUS AVANT ID.2400 | 1 | Nous consulter... | | | ⊘ |
| 45 | S139231C | PANNEAU DE DESSUS AVANT EQU | 1 | Nous consulter... | | | ⊘ |
| 46 | S500144 | ENS. DESSUS R4 980 FERROBLO | 1 | Nous consulter... | | | ⊘ |
| 46 | S1794053 | PANNEAU DESSUS L=700 ID.2400 | 1 | Nous consulter... | | | ⊘ |
| 46 | S500141 | ENS. DESSUS R4 560 FERROBLO | 1 | Nous consulter... | | | ⊘ |
| 46 | S1794055 | PANNEAU DESSUS L=980 ID.2400 | 1 | Nous consulter... | | | ⊘ |

| | | | | | |
|----|----------|--------------------------------|---|-------------------|---|
| 46 | S500143 | ENS. DESSUS R4 840 FERROBLO | 1 | Nous consulter... |  |
| 46 | S500142 | ENS. DESSUS R4 700 FERROBLO | 1 | Nous consulter... |  |
| 46 | S1794052 | PANNEAU DESSUS L=560 ID.2400 | 1 | Nous consulter... |  |
| 46 | S1794054 | PANNEAU DESSUS L=840 ID.2400 | 1 | Nous consulter... |  |
| 47 | S500128 | ENS. COTE AV. D. R4 FERROBLOC | 1 | Nous consulter... |  |
| 47 | S1794057 | PANNEAU COTE AV.DROIT ID.2400 | 1 | Nous consulter... |  |
| 48 | S1794057 | PANNEAU COTE AV.GAUCHE ID.24 | 1 | Nous consulter... |  |
| 48 | S500129 | ENS.COTE AV.G.R4 FERROBLOC | 1 | Nous consulter... |  |
| 49 | S1794063 | EQUERRE FIXATION COTES | 1 | 157,00 € | |
| 50 | S1794062 | PATTE FIXATION COTES | 1 | 145,00 € | |
| 51 | S1794061 | PANNEAU COTE L=980 ID.2400 | 1 | Nous consulter... |  |
| 51 | S1794061 | PANNEAU COTE L=980 ID.2400 | 1 | Nous consulter... |  |
| 51 | S1794061 | PANNEAU COTE L=980 ID.2400 | 1 | Nous consulter... |  |
| 51 | S500137 | ENS. COTE R4 560 FERROBLOC PF | 1 | Nous consulter... |  |
| 51 | S500137 | ENS. COTE R4 560 FERROBLOC PF | 1 | Nous consulter... |  |
| 51 | S500137 | ENS. COTE R4 560 FERROBLOC PF | 1 | Nous consulter... |  |
| 51 | S1794058 | PANNEAU COTE L=560 ID.2400 | 1 | Nous consulter... |  |
| 51 | S1794058 | PANNEAU COTE L=560 ID.2400 | 1 | Nous consulter... |  |
| 51 | S1794058 | PANNEAU COTE L=560 ID.2400 | 1 | Nous consulter... |  |
| 51 | S1794060 | PANNEAU COTE L=840 ID.2400 | 1 | Nous consulter... |  |
| 51 | S1794060 | PANNEAU COTE L=840 ID.2400 | 1 | Nous consulter... |  |
| 51 | S1794060 | PANNEAU COTE L=840 ID.2400 | 1 | Nous consulter... |  |
| 51 | S1794059 | PANNEAU COTE L=700 ID.2400 | 1 | Nous consulter... |  |
| 51 | S1794059 | PANNEAU COTE L=700 ID.2400 | 1 | Nous consulter... |  |
| 51 | S1794059 | PANNEAU COTE L=700 ID.2400 | 1 | Nous consulter... |  |
| 51 | S500138 | ENS. COTE R4 700 FERROBLOC PF | 1 | Nous consulter... |  |
| 51 | S500138 | ENS. COTE R4 700 FERROBLOC PF | 1 | Nous consulter... |  |
| 51 | S500138 | ENS. COTE R4 700 FERROBLOC PF | 1 | Nous consulter... |  |
| 51 | S500139 | ENS. COTE R4 840 FERROBLOC PF | 1 | Nous consulter... |  |
| 51 | S500139 | ENS. COTE R4 840 FERROBLOC PF | 1 | Nous consulter... |  |
| 51 | S500139 | ENS. COTE R4 840 FERROBLOC PF | 1 | Nous consulter... |  |
| 51 | S500140 | ENS. COTE R4 980 FERROBLOC PF | 1 | Nous consulter... |  |
| 51 | S500140 | ENS. COTE R4 980 FERROBLOC PF | 1 | Nous consulter... |  |
| 51 | S500140 | ENS. COTE R4 980 FERROBLOC PF | 1 | Nous consulter... |  |
| 52 | S1794071 | TOLE ARRIERE SUPERIEUR.ID.240 | 1 | Nous consulter... |  |
| 53 | S1794068 | PANNEAU ARRIERE INFER.ID.2400 | 1 | Nous consulter... |  |
| 53 | S500134 | ENS. PANN. INF AR R4 FERROBLO | 1 | Nous consulter... |  |
| 54 | S500135 | ENS. PANN. LAT AR R4 FERROBLO | 1 | Nous consulter... |  |
| 54 | S500135 | ENS. PANN. LAT AR R4 FERROBLO | 1 | Nous consulter... |  |
| 54 | S1794070 | PANNEAU ARRIERE LATERA.ID.240 | 1 | Nous consulter... |  |
| 54 | S1794070 | PANNEAU ARRIERE LATERA.ID.240 | 1 | Nous consulter... |  |
| 55 | S500130 | ENS. PANN. INF AV R4 FERROBLO | 1 | Nous consulter... |  |
| 55 | S1794064 | FACADE INFERIEURE ID.2400 | 1 | Nous consulter... |  |
| 56 | S500131 | ENS. PANNEAU AV. D. R4 FERROBI | 1 | Nous consulter... |  |
| 56 | S1794066 | FACADE DROITE ID.2400 | 1 | Nous consulter... |  |
| 57 | S1794066 | FACADE GAUCHE ID.2400 | 1 | Nous consulter... |  |
| 57 | S500132 | ENS. PANNEAU AV. G. R4 FERROBI | 1 | Nous consulter... |  |
| 58 | S505398 | ENS. PANNEAU SUP. AV R4 BLANC | 1 | Nous consulter... |  |
| 58 | S1794067 | PANNEAU SUP.AVANT EQUIP.2400 | 1 | Nous consulter... |  |
| 59 | S1788040 | SACHET VISSERIE JAQUETTE NXR | 1 | 202,00 € | |

