

06/05/2004

2022-GeodisFioul-Tableau.xls

Réf.	Référenc	Description	Qté	Tarif	Substitut	Tarif Sub.	Remarques
47	S131691	TABLEAU COMMANDE EQUIP"GEO	1	Nous consulter...			⊘
60	S132367	CABLAGE TABLEAU IS	1	418,00 €			
61	S500226	SONDE EXTERIEURE AFS	1	83,10 €			
62	S500173	SONDE BALLON SPFS LG:2M	1				
63	S500174	SONDE CHAUDIERE KFS LG:1M	1				
64	S500389	SACHET VOYANTS+FUSIBLE/PORT	1	80,30 €			
64	S500389	SACHET VOYANTS+FUSIBLE/PORT	1	80,30 €			
64A	S1580359	FUSIBLE VERRE T4A D=5X20	1	3,50 €			
65	S500390	SACHET INTERRUPTEURS	1	97,70 €			
65	S500390	SACHET INTERRUPTEURS	1	97,70 €			
66	S500452	MODULE D'AMBIANCE SEUL IS	1				⊘
66A	S500393	EMBASE MODULE D'AMBIANCE	1	75,90 €			
66B	S500391	CARTE ELECTRONIQUE EQUIPEE	1	428,00 €			
67	S131939	COUVERCLE TABLEAU EQUIPEE IS	1	Nous consulter...			
68	S500453	ENS.ELECTRONIQUE CHAUDIERE	1	179,00 €			
69	S500454	PIECES PLASTIQUE+ FIX.IS	1	Nous consulter...			⊘
69	S500454	PIECES PLASTIQUE+ FIX.IS	1	Nous consulter...			⊘
70	S500397	ENS.THERMOSTAT DE REGULATIC	1	99,40 €			
70A	S1700473	MANETTE THERMOSTAT	1	3,70 €			
71	S132377	BEQUILLE	1	76,60 €			
72	S1700695	THERMOSTAT TG400 CAP.2M 971.	1	33,20 €			
73	S132344	FOND DE TABLEAU	1	106,00 €			
74	S1720210	SONDE DE DEPART VFAS	1	65,80 €			



**PIECES ET ACCESSOIRES
DE RECHANGES**

157 avenue Charles Floquet 93158 LE BLANC-MESNIL CEDEX Téléphone 01 45 91 58 70 Télécopie 01 45 91 59 69



GEODIS B I

A PARTIR DE MARS 2000



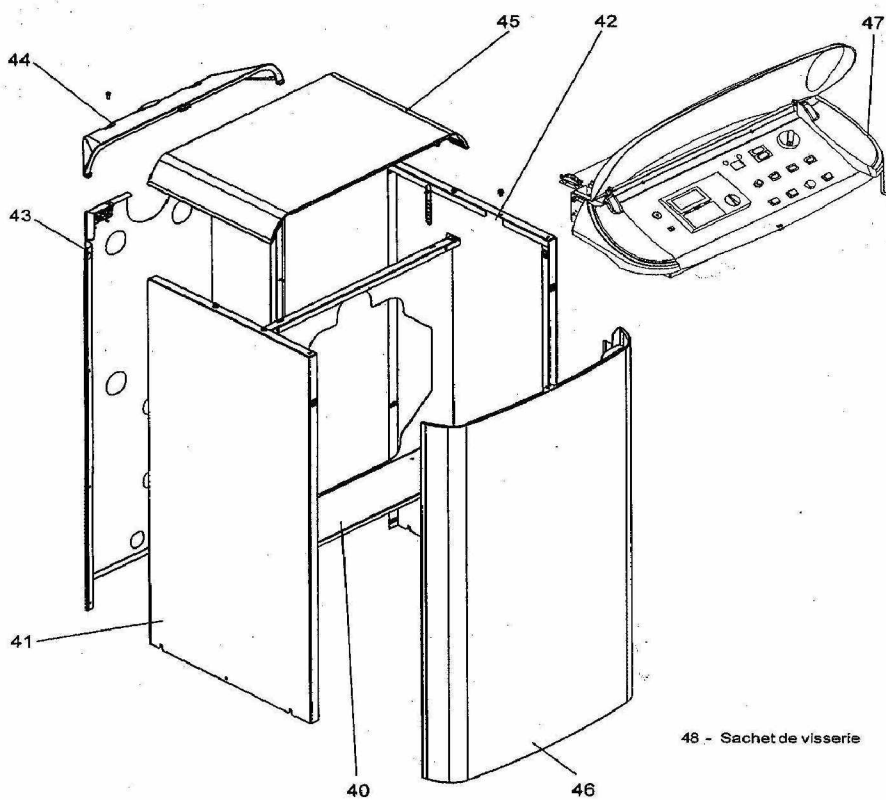











N° 2025	HABILLAGE	239
----------------	------------------	------------



- 40 - Façade interne équipée
- 41 - Côté gauche équipé
- 42 - Côté droit équipé
- 43 - Panneau arrière équipé
- 44 - Coiffe arrière
- 45 - Dessus
- 46 - Façade avant équipée
- 47 - Tableau de commande équipé

Schéma et repérage valables pour les pièces détachées selon Nomenclature N° 132727

GEODIS 24-30 Ci/Bi (2000-->2009)

Réf.	Référenc	Description	Qté	Tarif	Substitut	Tarif Sub.	Remarques
40	S132234	FACADE INTERNE PEINT EQUIPEE	1	Nous consulter...			
40	S132234	FACADE INTERNE PEINT EQUIPEE	1	Nous consulter...			
41	S132233B	COTE GAUCHE EQUIPE GEODIS BI	1	Nous consulter...			
41	S132233B	COTE GAUCHE EQUIPE GEODIS BI	1	Nous consulter...			
42	S132232B	COTE DROIT EQUIPE GEODIS BI	1	Nous consulter...			
42	S132232B	COTE DROIT EQUIPE GEODIS BI	1	Nous consulter...			
43	S132235B	TOLE ARRIERE EQUIPEE GEODIS E	1	Nous consulter...			
43	S132235B	TOLE ARRIERE EQUIPEE GEODIS E	1	Nous consulter...			
44	S131558E	COIFFE ARRIERE NOIRE	1	152,00 €			
44	S131558E	COIFFE ARRIERE NOIRE	1	152,00 €			
45	S131604B	DESSUS PEINT	1	Nous consulter...			
45	S131604B	DESSUS PEINT	1	Nous consulter...			
46	S132231	FACADE EQUIPEE GEODIS BI	1	Nous consulter...			
46	S132231	FACADE EQUIPEE GEODIS BI	1	Nous consulter...			
47	S131691	TABLEAU COMMANDE EQUIP"GEO	1	Nous consulter...			
47	S131691	TABLEAU COMMANDE EQUIP"GEO	1	Nous consulter...			
48	S500398	SACHET VISSERIE JAQUETTE BI	1	Nous consulter...			

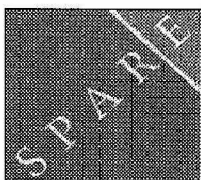

**PIECES ET ACCESSOIRES
DE RECHANGES**

157 avenue Charles Floquet 93158 LE BLANC-MESNIL CEDEX Téléphone 01 45 91 58 70 Télécopie 01 45 91 59 69



GEODIS C I

A PARTIR DE MARS 2000

N° 2023

CORPS ET EQUIPEMENT

237

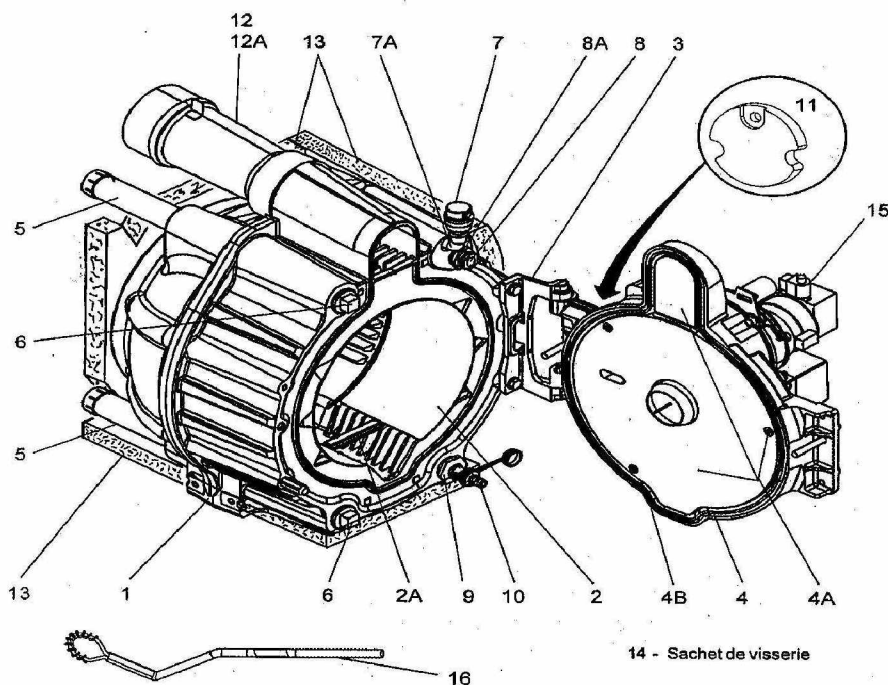

- | | |
|-----------------------------------|----------------------------------|
| 1 - Corps équipé | 7A - Courbe N° 1A 3/8" |
| 2 - Canaliséur 30 kW + entretoise | 8 - Doigt de gant |
| 2 - Canaliséur 24 kW + entretoise | 8A - Réduction N° 241 1"1/2 |
| 2A - Entretoise | 9 - Mamelon réduit 1"1/4-1/2 |
| 3 - Chape de porte seule | 10 - Robinet de vidange |
| 4 - Porte équipée | 11 - Volet oeilleton |
| 4A - Isolant porte + Fixations | 12 - Manchette de fumées + Joint |
| 4B - Joint de porte | 12A - Joint de manchette fumées |
| 5 - Manchettes eau | 13 - Ensemble calorifuge |
| 6 - Bouchon mâle N° 290 1" 1/4 | 15 - Brûleur 30 kW |
| 7 - Purgeur automatique 3/8" | 15 - Brûleur 24 kW |
| | 16 - Brosse de ramonage |

Schéma et repérage valables pour les pièces détachées selon Nomenclature N° 132931

GEODIS 24-30 Ci/Bi (2000-->2009)

Réf.	Référence	Description	Qté	Tarif	Substitué	Tarif Sub.	Remarques
1	S500349E	CORPS EQUIPE EPROUVE "SUM CI	1	1253,00 €			
1	S500349E	CORPS EQUIPE EPROUVE "SUM CI	1	1253,00 €			
2	S500451	CANALISATEUR 24KW + ENTRETOI	1	140,00 €			
2	S500451	CANALISATEUR 24KW + ENTRETOI	1	140,00 €			
2	S500451	CANALISATEUR 24KW + ENTRETOI	1	140,00 €			
2A	S500402	CANALISATEUR 30KW FIOUL - 24 K	1	131,00 €			
2B	S131557	ENTRETOISE DE VIROLE (BORA)	1				
3	S131350	CHAPE PEINT	1	Nous consulter...			⊘
3	S131350	CHAPE PEINT	1	Nous consulter...			⊘
4	S131507	ENS.PORTE EQUIPE	1	Nous consulter...			⊘
4	S131507	ENS.PORTE EQUIPE	1	Nous consulter...			⊘
4A	S500403	ISOLANT PORTE BRULEUR	1	155,00 €			
4A	S500403	ISOLANT PORTE BRULEUR	1	155,00 €			
4B	S1700019	TRESSE RONDE DE 16 (LE M) BLAN	1	19,20 €			
15	S089250	BRULEUR "524I" (SOCLE S421)	1				⊘
4B	S1700019	TRESSE RONDE DE 16 (LE M) BLAN	1	19,20 €			
5	S131862	MANCHETTE EAU 1"1/4 M-M	1	Nous consulter...			⊘
5	S131862	MANCHETTE EAU 1"1/4 M-M	1	Nous consulter...			⊘
5	S131862	MANCHETTE EAU 1"1/4 M-M	1	Nous consulter...			⊘
6	SN912651	BOUCHON MALE NR.290-1"1/4	1	Nous consulter...			⊘
6	SN912651	BOUCHON MALE NR.290-1"1/4	1	Nous consulter...			⊘
6	SN912651	BOUCHON MALE NR.290-1"1/4	1	Nous consulter...			⊘
7	S1700619	PURGEUR AUTOMATIQUE R88/13	1				
7	S1700619	PURGEUR AUTOMATIQUE R88/13	1				
7A	S500149	COURBE MF NÂ°1A 3/8"	1	75,50 €			
7A	S500149	COURBE MF NÂ°1A 3/8"	1	75,50 €			
8	SN911517	GAINE 1/2"NPT REF:555012	1	52,80 €			
8	SN911517	GAINE 1/2"NPT REF:555012	1	52,80 €			
8A	S1592420	REDUCTION GF241 1"X1/2"	1	Nous consulter...			⊘
8A	S1592420	REDUCTION GF241 1"X1/2"	1	Nous consulter...			⊘
9	S500350	MAMELON REDUIT NÂ°241 1"1/4-1/2	1	81,00 €			
9	S500350	MAMELON REDUIT NÂ°241 1"1/4-1/2	1	81,00 €			
10	S1700647	ROBINET DE VIDANGE 1/2"	1	33,90 €			
10	S1700647	ROBINET DE VIDANGE 1/2"	1	33,90 €			
11	S1786379	VOLET OEILLETON DE FLAMME	1	5,90 €			
11	S1786379	VOLET OEILLETON DE FLAMME	1	5,90 €			
12	S500404	MANCHETTE FUMEEES + JOINT	1	186,00 €			
12	S500404	MANCHETTE FUMEEES + JOINT	1	186,00 €			
12A	S1700016	TRESSE DE 7 SILICONEE (LE M)	1				
12A	S1700016	TRESSE DE 7 SILICONEE (LE M)	1				
13	S500405	ENS.CALORIFUGE CORPS	1	168,00 €			
13	S500405	ENS.CALORIFUGE CORPS	1	168,00 €			
13	S500405	ENS.CALORIFUGE CORPS	1	168,00 €			
14	S500406	SACHET VISSERIE	1	66,20 €			
15	S089255	BRULEUR "530I" (SOCLE S421)	1	Nous consulter...			⊘
15	S089255	BRULEUR "530I" (SOCLE S421)	1	Nous consulter...			⊘
15	S089255	BRULEUR "530I" (SOCLE S421)	1	Nous consulter...			⊘
16	S132807	BROSSE DE RAMONAGE	1	60,80 €			
16	S132807	BROSSE DE RAMONAGE	1	60,80 €			

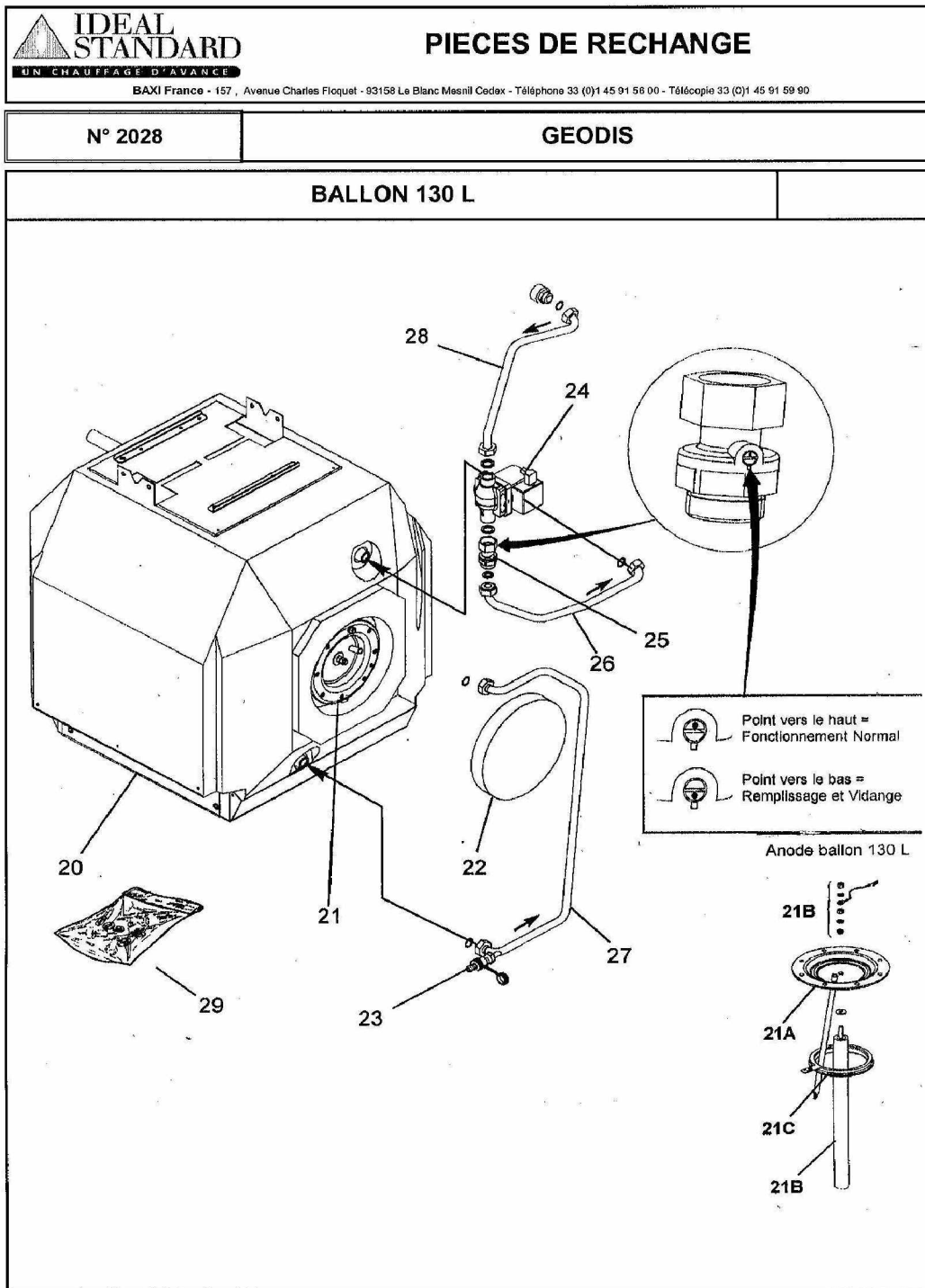

02/02/2005

2028-GeodisBi-Ballon.xls

GEODIS 24-30 Ci/Bi (2000-->2009)

Réf.	Référenc	Description	Qté	Tarif	Substitut	Tarif Sub.	Remarques
20	S131996	BALLON 130L SUM	1				
21	S132218	CONTRE BRIDE EQUIPE(130L)	1	192,00 €			
21A	S132217	CONTRE BRIDE EMAILLE(130l)	1	192,00 €			
21B	S500400	CABLE MASSE ANODE+GARNIT.	1	19,20 €			
21B	S500400	CABLE MASSE ANODE+GARNIT.	1	19,20 €			
21C	S130616	JOINT CONTRE BRIDE POUR SUM	1	35,00 €			
22	S132324	COUVERCLE ISOL.BAL.(130L)	1	54,30 €			
23	S131960	TE DE VIDANGE 3/4"(130L)	1				
24	S132335	POMPE CP53 1"POS.4 (130L)	1				
24A	S137393	CABLE DE POMPE L:1500	1	23,40 €			
25	S132200	CLAPET ANTIRETOUR 1"M-1"F	1	16,50 €			
26	S133652	TUBE RACCORDEMENT DEPART	1	23,00 €			
26	S131541	FLEXIBLE COUDE 3/4"-COUDE 1"	1	46,90 €			
27	S138073	TUBE RACCORDEMENT RETOUR	1	47,00 €			
27	S132275	FLEXIBLE COUDE-DROIT 3/4"	1				
28	S131884	TUBULURE RAC POMPE 3/4"+ECRC	1				
28	S133650	TUBE RACCORDEMENT	1				
29	S500401	POCHETTE JOINTS ENS.HYDRAUL	1				

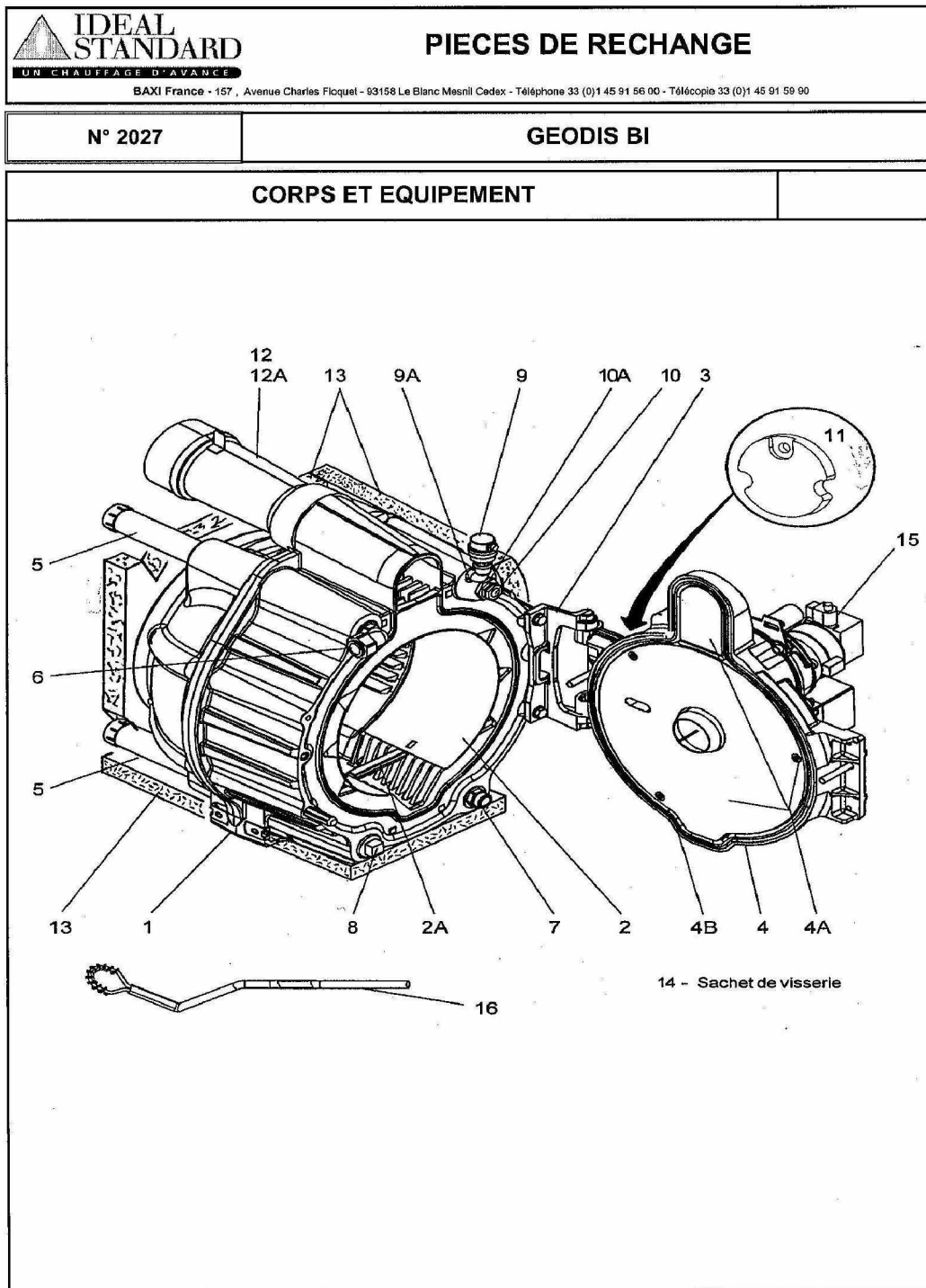

03/05/2004

2027-GeodisBi-Corps.xls

Réf.	Référenc	Description	Qté	Tarif	Substitut	Tarif Sub.	Remarques
1	S500093E	CORPS EQUIPE EPROUVE "SUM BI	1	1738,00 €			
2	S500402	CANALISATEUR 30KW FIOUL - 24 K	1	131,00 €			
2	S500451	CANALISATEUR 24KW + ENTRETOI	1	140,00 €			
2A	S131557	ENTRETOISE DE VIROLE (BORA)	1				
3	S131350	CHAPE PEINT	1	Nous consulter...			⊘
4	S131507	ENS.PORTE EQUIPE	1	Nous consulter...			⊘
4A	S500403	ISOLANT PORTE BRULEUR	1	155,00 €			
4B	S1700019	TRESSE RONDE DE 16 (LE M) BLAN	1	19,20 €			
5	S131862	MANCHETTE EAU 1"1/4 M-M	1	Nous consulter...			⊘
5	S131862	MANCHETTE EAU 1"1/4 M-M	1	Nous consulter...			⊘
6	S131883	COUDE 1"1/4	1	120,00 €			
7	S132178	MAMELON REDU.1"1/4M-3/4"M	1	95,60 €			
8	SN912651	BOUCHON MALE NR.290-1"1/4	1	Nous consulter...			⊘
9	S1700619	PURGEUR AUTOMATIQUE R88/13	1				
9A	S500149	COURBE MF NÃ°1A 3/8"	1	75,50 €			
10	SN911517	GAINÉ 1/2"NPT REF:555012	1	52,80 €			
10A	S1592420	REDUCTION GF241 1"X1/2"	1	Nous consulter...			⊘
11	S1786379	VOLET OEILLETON DE FLAMME	1	5,90 €			
12	S500404	MANCHETTE FUMÉES + JOINT	1	186,00 €			
12A	S1700016	TRESSE DE 7 SILICONEE (LE M)	1				
13	S500405	ENS.CALORIFUGE CORPS	1	168,00 €			
13	S500405	ENS.CALORIFUGE CORPS	1	168,00 €			
14	S500406	SACHET VISSERIE	1	66,20 €			
15	S089255	BRULEUR "530" (SOCLE S421)	1	Nous consulter...			⊘
15A	S089250	BRULEUR "524" (SOCLE S421)	1				⊘
16	S132807	BROSSE DE RAMONAGE	1	60,80 €			



**PIECES ET ACCESSOIRES
DE RECHANGES**

157 avenue Charles Floquet 93158 LE BLANC-MESNIL CEDEX Téléphone 01 45 91 58 70 Télécopie 01 45 91 59 69





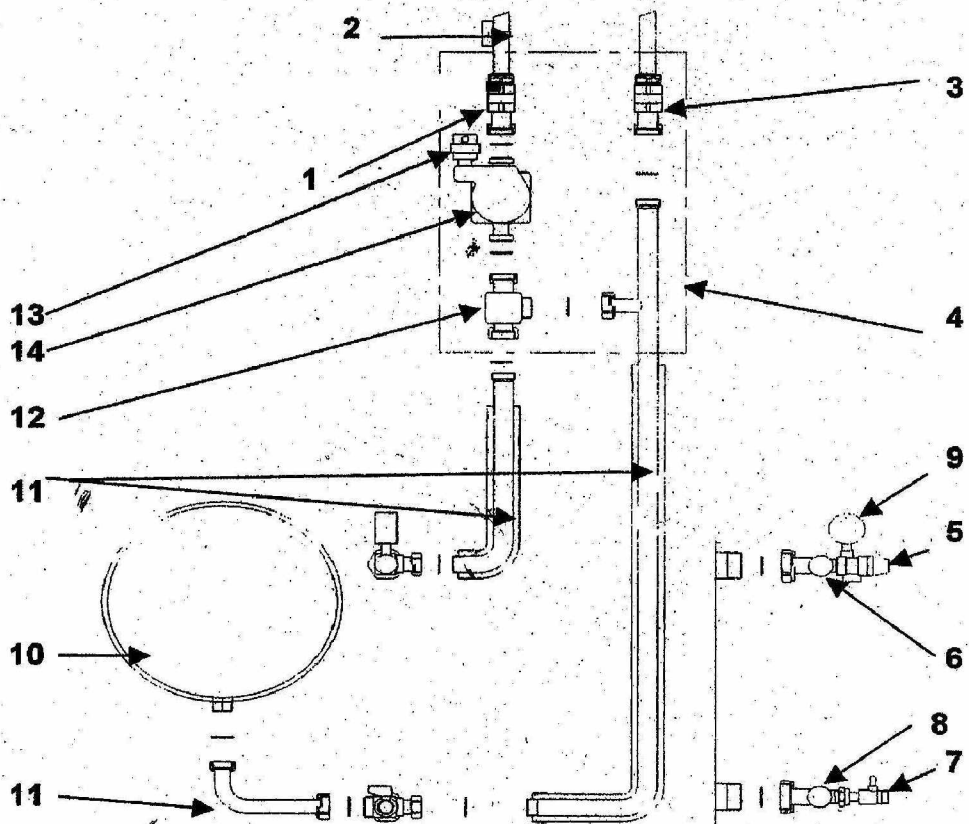

GEODIS

A PARTIR DE 2002

N° 2270	MODULE ECO CHAUFFAGE	490
----------------	-----------------------------	------------



GEODIS 24-30 Ci/Bi (2000-->2009)

Réf.	Référenc	Description	Qté	Tarif	Substitut	Tarif Sub.	Remarques
1	S1999945	VANNE SPHERE BALLSTOP AV/CL/	1	Nous consulter...			
-1	S133071	PRISE DE PURGE	1	8,60 €			
-1	S1750965	MOTEUR VANNE SME130 230V (mo	1				
-1	S133180	TUYAU SOUPLE NOIR D:6 LG:10cm	1	4,30 €			
2	S1720210	SONDE DE DEPART VFAS	1	65,80 €			
3	S1999945	VANNE SPHERE 195 FG1"xD22 (VS	1	Nous consulter...			
4	S1999945	BOITE ISOLANTE P/ECO SUM "moc	1	73,90 €			
5	S1999945	CROIX DEP.FG1"1/4xFG3/4"xM1/2"(t	1	49,00 €			
6	S1999945	SOUPAPE SECU.1/2"Z 3B (2113	1	21,40 €			
7	S1999945	VANNE SPHERE EQU.2300/04S (v	1	30,00 €			
8	S1999945	CROIX RET.FG1"1/4xM1"xFG3/4xM1	1	Nous consulter...			
9	S1999945	MANOMETRE D:50 RADIAL 4B(MR0	1	15,80 €			
10	S1999946	VASE CIRCULAIRE 541 12/1 3/4M (v	1	134,00 €			
10	S1999946	VASE CIRCULAIRE 541 12/1 3/4M (v	1	134,00 €			
10	S1750965	VASE EXPANSION MOD.CHAUF.(12	1	64,80 €			
10	S1750965	VASE EXPANSION MOD.CHAUF.(12	1	64,80 €			
11	S1999945	TUBULURES + JOINTS (OF1) "MC	1	Nous consulter...			
11	S1999945	TUBULURES + JOINTS (OF1) "MC	1	Nous consulter...			
12	S1999945	VANNE MELANG.3V.FG1"xFG1"xM1	1	118,00 €			
13	S1999946	PURGEUR ROBOCAL AVEC CLAPE	1				
14	S501552	POMPE MYSON CP53-130 1"+DEGA	1				



**PIECES ET ACCESSOIRES
DE RECHANGES**

157 avenue Charles Floquet 93158 LE BLANC-MESNIL CEDEX Téléphone 01 45 91 58 70 Télécopie 01 45 91 59 69



GEODIS

A PARTIR DE DECEMBRE 2000

N° 2098	OPTIONS REGULATION	318
----------------	---------------------------	------------

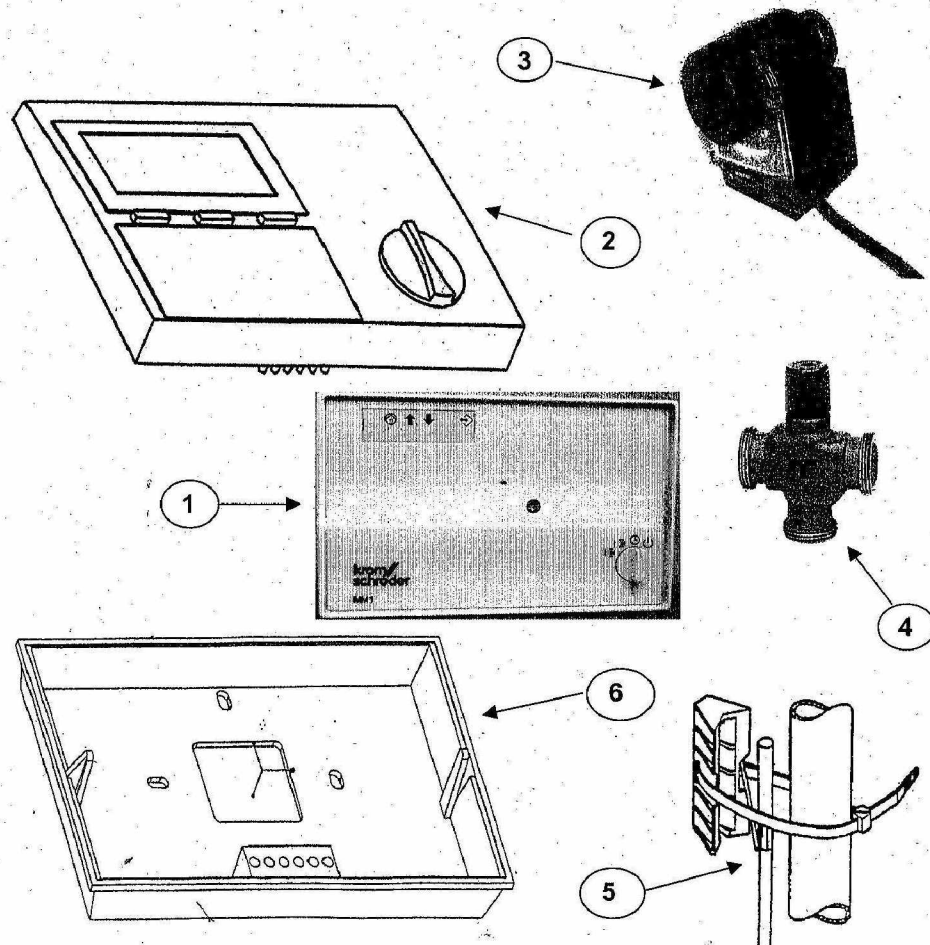

Réf.	Référenc	Description	Qté	Tarif	Substitut	Tarif Sub.	Remarques
0	S131541	FLEXIBLE COUDE 3/4"-COUDE 1"	1	46,90 €			
0	S131884	TUBULURE RAC POMPE 3/4"+ECRC	1				⊘
0	S130616	JOINT CONTRE BRIDE POUR SUM	1	35,00 €			
0	S500226	SONDE EXTERIEURE AFS	1	83,10 €			
0	S500174	SONDE CHAUDIERE KFS LG:1M	1				
0	S500400	CABLE MASSE ANODE+GARNIT.	1	19,20 €			
0	S132324	COUVERCLE ISOL.BAL.(130L)	1	54,30 €			
0	S133650	TUBE RACCORDEMENT	1				
0	S138073	TUBE RACCORDEMENT RETOUR	1	47,00 €			
0	S500173	SONDE BALLON SPFS LG:2M	1				
0	S132200	CLAPET ANTIRETOUR 1"M-1"F	1	16,50 €			
0	S132335	POMPE CP53 1"POS.4 (130L)	1				
0	S131996	BALLON 130L SUM	1				
0	S131960	TE DE VIDANGE 3/4"(130L)	1				
0	S133652	TUBE RACCORDEMENT DEPART	1	23,00 €			
0	S132275	FLEXIBLE COUDE-DROIT 3/4"	1				
0	S132218	CONTRE BRIDE EQUIPE(130L)	1	192,00 €			
0	S500401	POCHETTE JOINTS ENS.HYDRAUL	1				
0	S132217	CONTRE BRIDE EMAILLE(130I)	1	192,00 €			
2	S500452	MODULE D'AMBIANCE SEUL IS	1				⊘
3	S1700494	MOTEUR SSY319/30 (28/01/04 S	1	329,00 €			
4	S1700764	VANNE VXG 48.40	1	233,00 €			
4	S1700764	VANNE VXG 48-25 MV	1	Nous consulter...			⊘
4	S1700764	VANNE VXG 48-32 MV	1	455,00 €			
4	S1700764	VANNE VXG 48-20 MV	1	335,00 €			
4	S500675	VANNE VXP 456.20.4	1	Nous consulter...			⊘
5	S1720210	SONDE DE DEPART VFAS	1	65,80 €			
6	S500393	EMBASE MODULE D'AMBIANCE	1	75,90 €			

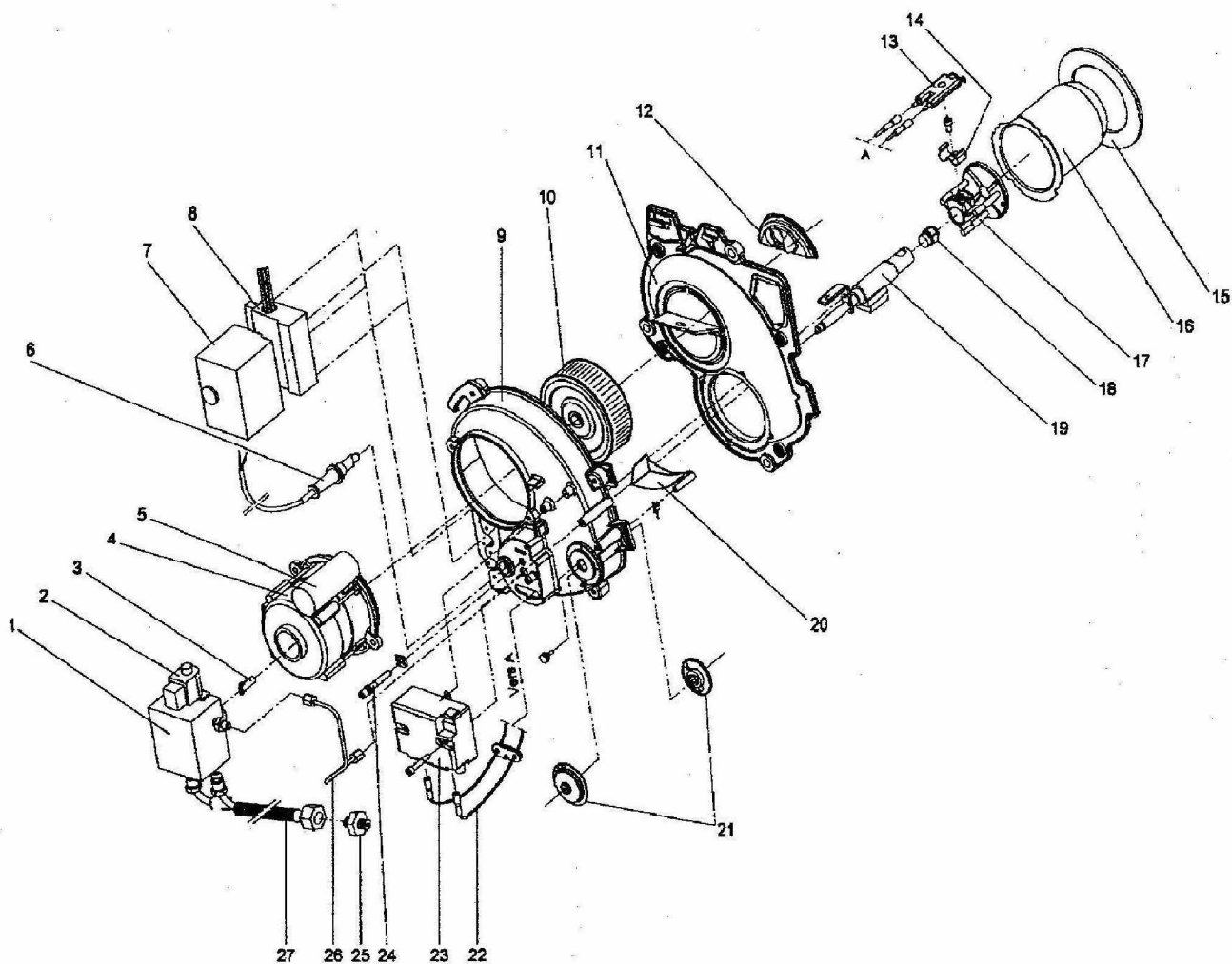

GEODIS 24-30 Ci/Bi (2000-->2009)

Réf.	Référenc	Description	Qté	Tarif	Substitut	Tarif Sub.	Remarques
1	S5832915	POMPE SUNTEC AS47C 1603 1P05I	1	135,00 €			
2	S5832761	ELECTROV. 220V CPLT POMPE AS	1	83,70 €			
3	S5840993	ACCOUPLMENT AEG 881 SAM4	1	6,60 €			
4	S5820989	MOTEUR 70W AVEC ACCOUP.L.AEC	1	143,00 €			
5	S9990865	CONDENSATEUR 3MF 450V AVEC I	1	7,10 €			
6	S5780579	CELLULE 8209	1	40,30 €			
7	S5853986	BLOC ACTIF MA55 D - 10M	1	198,00 €			
8	S5853986	SOCLE PRECABLE S421 BR.500/R	1	Nous consulter...			⊘
9	S5808451	VOLUTE + VISSERIE	1				⊘
10	S5840995	TURBINE 108X34 FERGAS	1	21,90 €			
11	S5808451	PLAQUE AVANT BR.500I	1	Nous consulter...			⊘
12	S5811938	OEILLARD	1	Nous consulter...			⊘
13	S5852843	BLOC D'ELECTRODES BR.500/700	1	9,10 €			
14	S5808451	RESSORT ELECTRODES + VIS	1	38,00 €			
15	S5839011	JOINT PLAQUE DE FACADE	1	6,10 €			
16	S5816970	TUYERE BR.500I	1	59,70 €			
17	S5808451	S/E CENTREUR STABILO BR.500	1	33,40 €			
18	S5003267	GICLEUR DELAVAN 0,50G 60Å°CT \	1	19,70 €			
18	S5003267	GICLEUR DELAVAN 0,65G 60Å°CT \	1	19,30 €			
18	S5003310	GICLEUR DELAVAN 0,55G 60Å° W	1	19,50 €			
19	S5834802	LIGNE FIOUL RECHAUFFEE BR.500	1	Nous consulter...			⊘
20	S5808452	VOLET D'AIR EQUIPE	1	69,20 €			
21	S5808452	CAME + BOUTON	1	69,60 €			
22	S5808452	FILS HT BR.500 UNIT REP.1	1	18,90 €			
23	S5850424	TRANSFORMATEUR EM 40/15 4039	1	Nous consulter...			⊘
24	S5808452	VIS DE REGLAGE + EPINGLE	1	Nous consulter...			⊘
25	S5837184	MAMELON PARIGI 3/8 X 3/8 C	1	4,40 €			
26	S5871667	TUBULURE POMPE LIG.BR.500I	1	Nous consulter...			⊘
27	S5836662	FLEXIBLE NW4 FC 3/8-MG 1/4 90Å°(1	37,70 €			
27	S5836662	FLEXIBLE ST6 MG 1/4 90Å°-FC 3/8	1	25,90 €			
28	S5808452	POCHETTE VISSERIE BR.500	1	Nous consulter...			⊘
29	S5880833	CLE 6 PANS DE 4	1	Nous consulter...			⊘



**PIECES ET ACCESSOIRES
DE RECHANGES**

157 avenue Charles Floquet 93158 LE BLANC-MESNIL CEDEX Téléphone 01 45 91 58 70 Télécopie 01 45 91 59 69



GEODIS C I

A PARTIR DE MARS 2000

N° 2021	HABILLAGE	235
----------------	------------------	------------











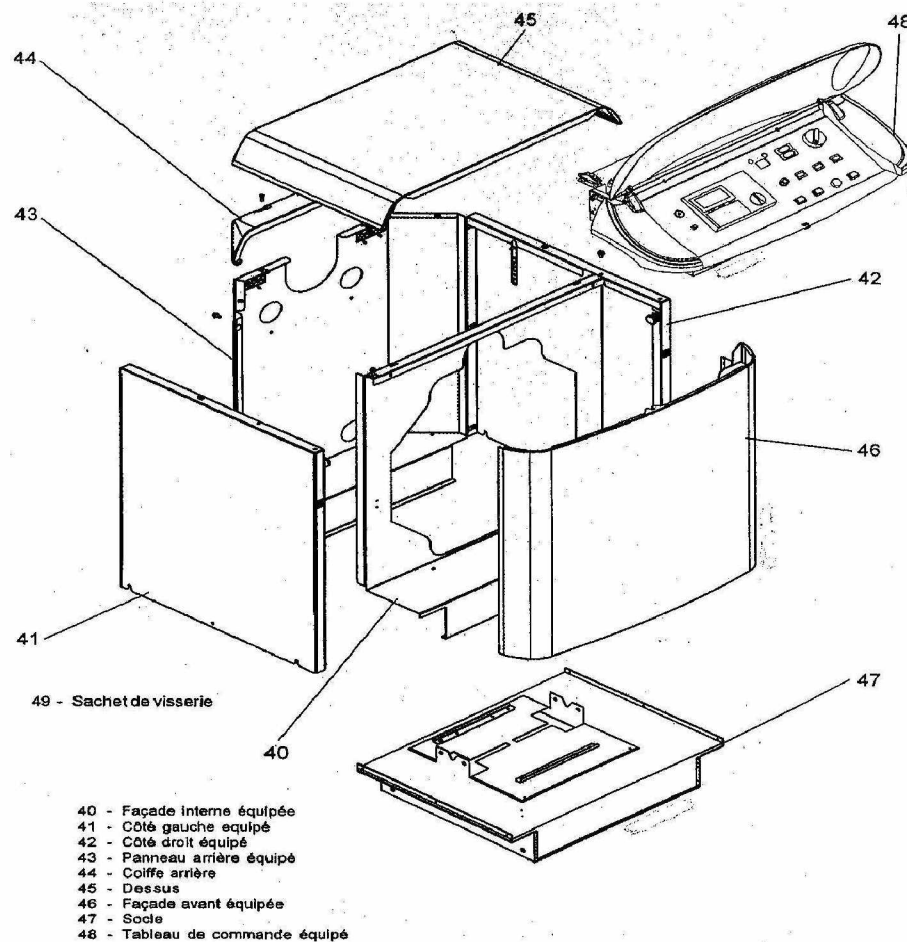

















Schéma et repérage valables pour les pièces détachées selon Nomenclature N° 132928

GEODIS 24-30 Ci/Bi (2000-->2009)

Réf.	Référenc	Description	Qté	Tarif	Substitut	Tarif Sub.	Remarques
40	S132682	FACADE INTERNE EQUIPEE BORA	1	Nous consulter...			
40	S132682	FACADE INTERNE EQUIPEE BORA	1	Nous consulter...			
40	S132682	FACADE INTERNE EQUIPEE BORA	1	Nous consulter...			
40	S137364E	FACADE INTERNE CI	1	Nous consulter...			
40	S137364E	FACADE INTERNE CI	1	Nous consulter...			
40	S137364E	FACADE INTERNE CI	1	Nous consulter...			
41	S132456B	COTE GAUCHE EQUIPE GEODIS CI	1	Nous consulter...			
41	S132456B	COTE GAUCHE EQUIPE GEODIS CI	1	Nous consulter...			
42	S132455B	COTE DROIT EQUIPE GEODIS CI	1	Nous consulter...			
42	S132455B	COTE DROIT EQUIPE GEODIS CI	1	Nous consulter...			
43	S132457B	TOLE ARRIERE EQUIPEE CVI 35KW	1	Nous consulter...			
43	S132457B	TOLE ARRIERE EQUIPEE CVI 35KW	1	Nous consulter...			
44	S131558E	COIFFE ARRIERE NOIRE	1	152,00 €			
44	S131558E	COIFFE ARRIERE NOIRE	1	152,00 €			
45	S131604B	DESSUS PEINT	1	Nous consulter...			
45	S131604B	DESSUS PEINT	1	Nous consulter...			
46	S132453	FACADE EQUIPEE GEODIS CI	1	Nous consulter...			
46	S132453	FACADE EQUIPEE GEODIS CI	1	Nous consulter...			
47	S132462	SOCLE EQUIPE CI	1	Nous consulter...			
47	S132462	SOCLE EQUIPE CI	1	Nous consulter...			
47	S132462	SOCLE EQUIPE CI	1	Nous consulter...			
47	S134210	SOCLE EQUIPE CI	1	Nous consulter...			
47	S134210	SOCLE EQUIPE CI	1	Nous consulter...			
47	S134210	SOCLE EQUIPE CI	1	Nous consulter...			
47	S134210	SOCLE EQUIPE CI	1	Nous consulter...			
48	S131691	TABLEAU COMMANDE EQUIP"GEO	1	Nous consulter...			
48	S131691	TABLEAU COMMANDE EQUIP"GEO	1	Nous consulter...			
49	S500499	SACHET VISSERIE JAQUETTE CI	1	63,50 €			