

*LISTE DE PIECES*

20/06/2016

---

<i>Produit</i>	537381 - R 3403 G25 25 mbar
<i>Modèle</i>	R 3400 & R 3500 & R3600
<i>Marque</i>	RENDAMAX
<i>Date</i>	16/03/2015

---

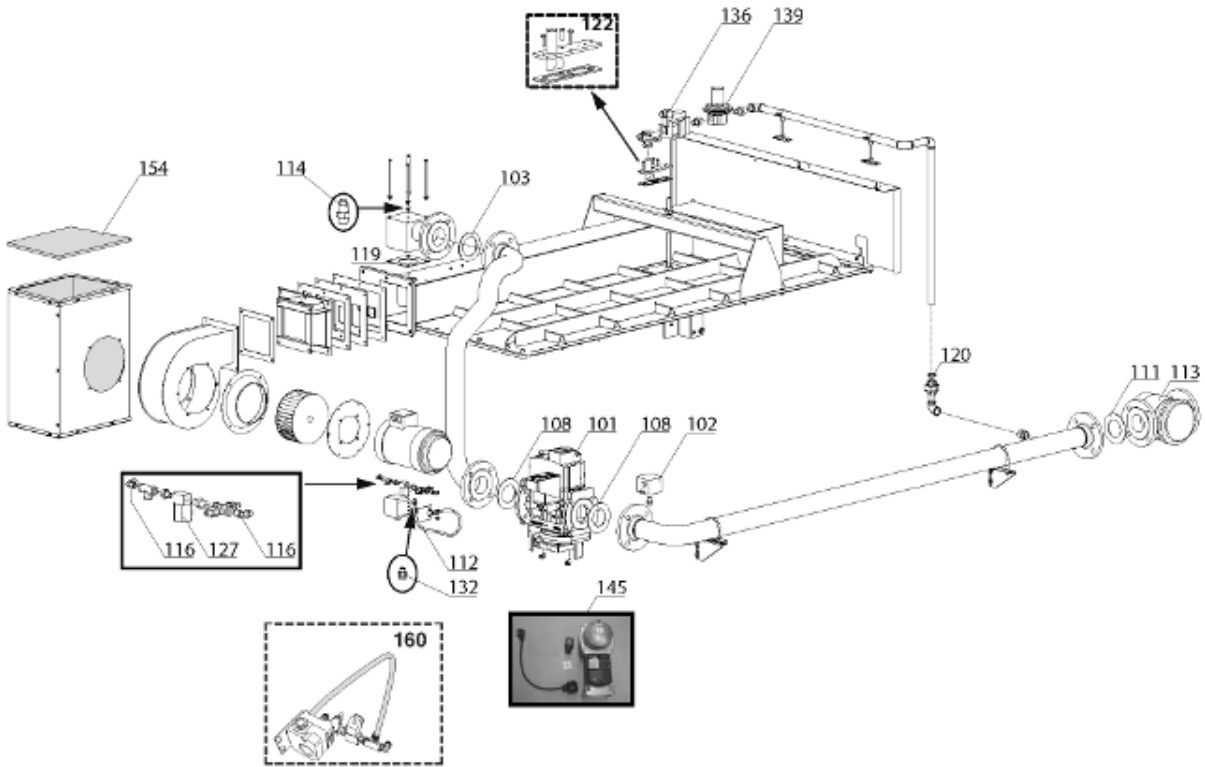
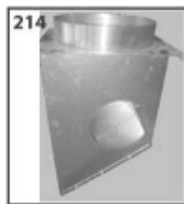
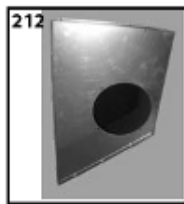

Table		PARTIE GAZ								
Rep.	Référence	ALIAS	Désignation	Remplacé par	Date début	Date fin	Multiple de vente	Tarif Public Unitaire HT		
101	64200116		VANNE GAZ KIT MBC-1200-VEF 1-3			07/07	1	3 655,50		
101	65000257		VANNE GAZ DUNGS MBC-1200-VEF R3456 1-6		07/07		1	2 103,30		
102	64201433		PRESSOSTAT GAZ 0-->150mb			07/07	1	176,60		
102	64401601		PRESSOSTAT GAZ GW 50 0 --> 50mb			07/07	1	79,00		
102	12084366		PRESSOSTAT + JOINT		07/07		1	97,60		
103	64200568		JOINT DE FORME D:78-60-2				1	16,40		
111	64201425		JOINT PLAT D:120-70-3				1	15,00		
112	64280527		TUBE SOUPLE TEFLON D:6/8 L: 2M				1			
113	64280124		FILTRE GAZ				1	147,80		
114	64211101		PRISE DE PRESSION 1/8				1	2,70		
116	64200854		RACCORD HAAKS 1/4 8mm				1	8,40		
116	64200855		RACCORD COUDE 1/8 8MM				1	8,10		
119	64200989		JOINT DE FORME				1	13,30		
120	12038584		JOINT 3/4				1	6,30		
122	65107922		INJECTEUR VEILLEUSE				1	184,80		
127	64200283		ELECTROVANNES 230V				1	173,60		
127	64200297		ELECTROVANNES 240V				1	117,60		
132	64200853		RACCORD DROIT 1/8 M				1	7,60		
136	64350002		ELECTROVANNE GAZ pour pilote CG 10				1	227,30		
139	64201438		REGULATEUR GAZ				1	233,10		
154	64280125		FILTRE A AIR 342X200X15				1	10,60		
160	17016093		PRESSOSTAT AIR				1			
160	17016092		PRESSOSTAT AIR				1			



<b>Table</b>		<b>GROUPE VENTILATION</b>							
<i>Rep.</i>	<i>Référence</i>	<i>ALIAS</i>	<i>Désignation</i>	<i>Remplacé par</i>	<i>Date début</i>	<i>Date fin</i>	<i>Multiple de vente</i>	<i>Tarif Public Unitaire HT</i>	
201	64280314		MOTEUR VENTILATEUR 2X1100W				1	893,40	
202	64200316		TURBINE D'EXTRACTEUR				1	124,00	
203	64202276		JOINT ISOLATION 25X3mm L:20m (neopr.)				1	188,70	
204	64201435		COLLERETTE				1	89,70	
205	64202284		VENTILATEUR				1		
207	64202276		JOINT ISOLATION 25X3mm L:20m (neopr.)				1	188,70	
208	17017130		PANNEAU RESTRICTION				1	45,10	
209	64202298		REDUCTEUR				1	269,10	
210	65107916		COUVERCLE SUPERIEUR				1	2 119,90	
211	65107927		COUVERCLE & PLAQUE DE POIDS				1	275,40	
212	65107923		PRISE D'AIR				1	592,10	
213	65107924		PRISE D'AIR + FILTRE				1	575,60	
214	65107949		PRISE D'AIR / CHAMBRE ETANCHE				1	485,50	

300



Table		BLOC HYDRAULIQUE							
Rep.	Référence	ALIAS	Désignation	Remplacé par	Date début	Date fin	Multiple de vente	Tarif Public Unitaire HT	
301	64210206		CONTROLEUR DEBIT EAU F61-SB9100				1	223,70	
302	64211228		ROBINET 1/2 (VANNE VIDANGE)				1	36,80	
304	64200296		SOUPAPE SECURITE 5 BARS D:1 1/2				1	763,60	
304	17016757		SOUPAPE SECURITE 5 BARS 2 TUV				1		
304	17016758		SOUPAPE SECURITE 6 BARS 2 TUV				1		
304	17016756		SOUPAPE SECURITE 4 BARS 2 TUV				1		
304	64211304		SOUPAPE SECURITE 3 BARS D:1 1/2				1	475,00	
304	64201418		SOUPAPE SECURITE 3 BARS TUV				1	437,20	
305	64280522		SONDE DC (/ KM 628)				1	41,90	
306	65000459		MANOMETRE 0-10 BARS				1	202,40	
306	64201240		MANOMETRE 0-6 BARS				1	131,50	
306	64210903		MANOMETRE 0-4 BARS				1	32,20	
306	64200087		RACCORD / MANOMETRE 0-->4 bars				1	24,00	
307	64201932		POMPE TP65/120				1	2 427,50	
308	64201241		PRESSOSTAT SDBRAM (MAX)				1	590,20	
309	64201242		PRESSOSTAT HUBA 625.9978 (MIN)				1	130,70	
311	4478694220		DOIGT DE GANT R9/R18				1		
314	64200998		JOINT PLAT D: 115-77-3				1	9,10	
316	64200995		JOINT PLAT D: 131-84-3				1	7,10	
317	12083849		VOYANT DE CONTROLE (FLAMME) AVEC MIROIR				1	171,30	
318	65108160		TUYAU DE SIPHON 1/2				1	86,10	
320	64210811		JOINT PLAT D:100-55-3				1	7,20	
321	64280467		RACCORD BICONE DROIT 1/8 D.8				1	14,00	
324	65107946		KIT GARNITURE+BOULON+ECROU				1	1 198,50	
325	64200511		JOINT 25X5X25000 mm PTFE				1		
326	65108209		RACCORD 1/8 D.8				1	15,40	
327	65108213		TUBE CUIVRE 6X8 mm L:2m				1	149,00	

400





<b>Table</b>		<b>RAMPE GAZ</b>							
<i>Rep.</i>	<i>Référence</i>	<i>ALIAS</i>	<i>Désignation</i>	<i>Remplacé par</i>	<i>Date début</i>	<i>Date fin</i>	<i>Multiple de vente</i>	<i>Tarif Public Unitaire HT</i>	
401	65107941		PLAQUE PREMELANGEUSE				1	368,40	
402	12038485		JOINT			01/05	1	203,90	
402	64201429		JOINT DE FORME		01/05		1	46,40	
405	65108146		RESSORT DE PRESSION (10pcs)				1	32,10	
406	64200229		ISOLANT ADHESIF NOIR 10X6mm L:10m				1	147,00	
407	12016166		JOINT 12X3X20000 mm NEOPR.				1		
408	65107946		KIT GARNITURE+BOULON+ECROU				1	1 198,50	
409	64200511		JOINT 25X5X25000 mm PTFE				1		



<b>Table</b>		<b>BRULEUR</b>							
<i>Rep.</i>	<i>Référence</i>	<i>ALIAS</i>	<i>Désignation</i>	<i>Remplacé par</i>	<i>Date début</i>	<i>Date fin</i>	<i>Multiple de vente</i>	<i>Tarif Public Unitaire HT</i>	
501	64200222		BRULEUR (KIT)				1	7 124,20	
502	64202264		ELECTRODE ALLUMAGE + JOINT				1	47,50	
503	64201562		ELECTRODE IONISATION				1	57,00	
504	64200325		JOINT DE FORME				1	4,00	
505	17010022		RACCORD M F				1	18,10	



<b>Table</b>		<b>ECHANGEUR</b>							
<i>Rep.</i>	<i>Référence</i>	<i>ALIAS</i>	<i>Désignation</i>	<i>Remplacé par</i>	<i>Date début</i>	<i>Date fin</i>	<i>Multiple de vente</i>	<i>Tarif Public Unitaire HT</i>	
601	64280631		ECHANGEUR 1				1	7	516,70
602	64280632		ECHANGEUR 2 (TUBES AILETTES)				1	13	096,60
607	4968707355		ISOLANT BLANC 14.64X0.013X0.085m				1	158,30	
608	64200834		ISOLANT 420X15X15mm				1	149,80	
609	64200830		ISOLANT 20X0.6X0.025 m				1	311,80	
610	64200817		ISOLANT 751X152X10mm				1	169,10	
611	12039222		ISOLANT 600X152X25mm				1	176,90	
612	64200815		ISOLANT LATERAL L:5m 50X5mm				1	131,80	
613	12039288		ISOLANT 680X116X25mm				1	171,90	

700



<b>Table</b>		<b>CONDENSEUR</b>							
<i>Rep.</i>	<i>Référence</i>	<i>ALIAS</i>	<i>Désignation</i>	<i>Remplacé par</i>	<i>Date début</i>	<i>Date fin</i>	<i>Multiple de vente</i>	<i>Tarif Public Unitaire HT</i>	
701	64202276		JOINT ISOLATION 25X3mm L:20m (neopr.)				1	188,70	
702	64200436		JOINT L:5m				1		
703	4148707742		COUVERCLE D'INSPECTION COMPLET				1	394,70	
703	6100055		INSPECTION BLIND HATCH COMPLETE				1	296,10	
710	65000427		RECUPERATEUR DE CONDENSAT				1	767,90	
712	65107945		BASE DE CHEMINEE				1	791,00	
717	64200822		PIEDS COMPLET (Qt:4)				1	184,60	

800

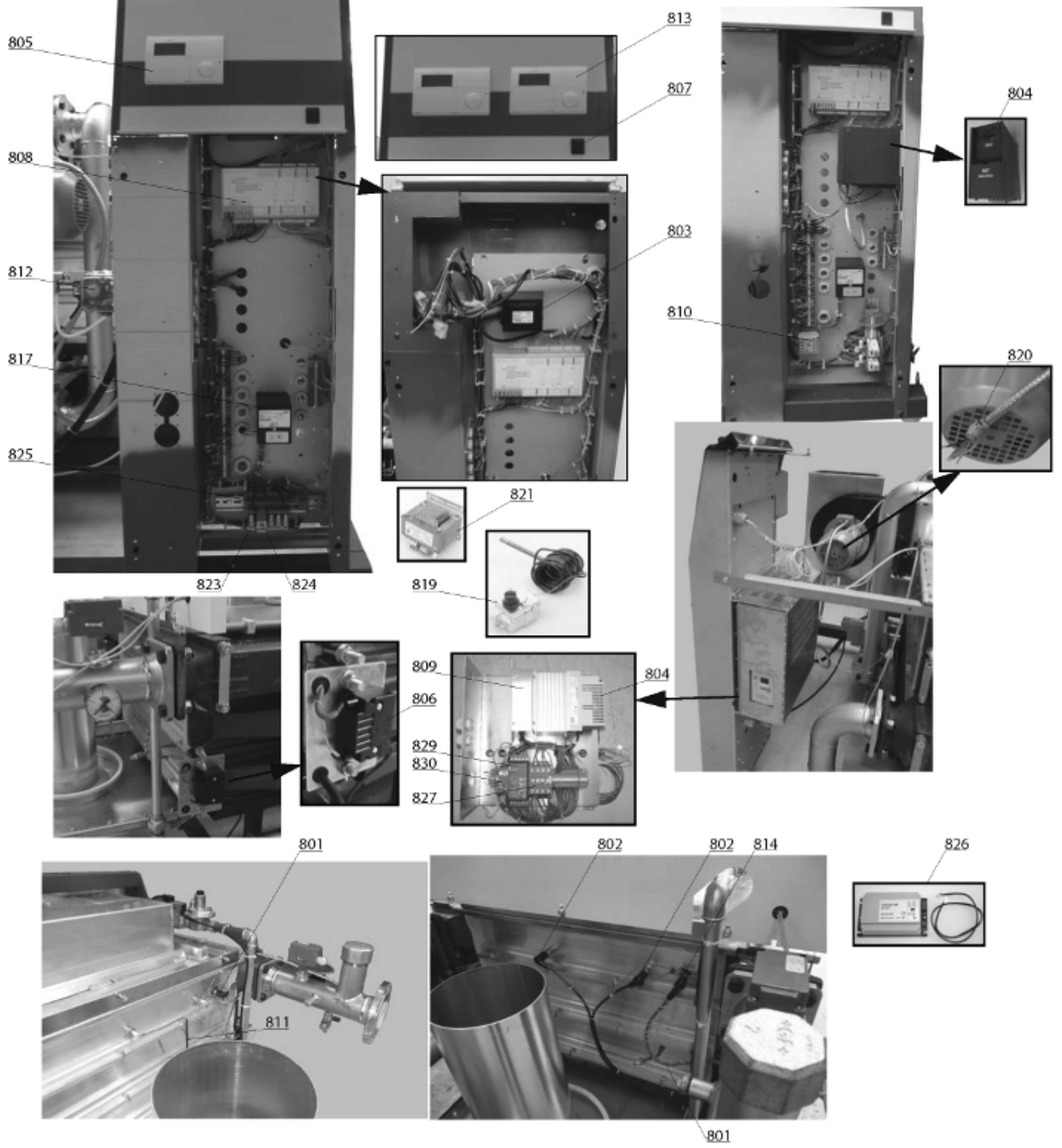



Table		BOITIER ELECTRIQUE								
Rep.	Référence	ALIAS	Désignation	Remplacé par	Date début	Date fin	Multiple de vente	Tarif Public Unitaire HT		
801	64201884		CABLAGE ELECTR. ALLU.				1			
802	64210409		EMBOUT COUDE ELECTRODE IONISATION				1	24,80		
803	64202438		TRANSFORMATEUR 220V / KM628				1	141,90		
804	64201573		VARIATEUR DE FREQUENCE				1	624,00		
805	65000234		BOITIER DE COMMANDE KM628				1	574,90		
806	64201641		TRANSFORMATEUR ALLUMAGE+CABLE 2P				1	119,20		
807	64200294		INTERRUPTEUR				1	38,10		
808	64280310		CIRCUIT IMPRIME CXE				1	438,80		
808	64202260		CONNECTEUR M (KIT) pour 64280310				1	119,70		
809	64201440		FILTRE ANTIPARASITE				1	317,00		
810	64201538		RELAIS ALAN BRADLEY 100-K09-KF10				1	89,30		
810	64201539		RELAIS 100-K09KF10 & 193-K40 (A&B)				1	260,00		
811	64201300		CABLAGE ELECTRODE IONISATION				1	134,90		
812	64280407		PRESSOSTAT DIFFERENTIEL				1	109,10		
813	65000251		MODULE DE GESTION KKM8				1	921,50		
813	65000252		REGULATEUR DE CHAUF (TYPE E8)				1	533,60		
813	64200788		MODULE CLIMATIQUE BM8				1	560,30		
814	64210410		EMBOUT ELECTRODE HT				1	21,20		
817	64201832		CONTROLE IONISA. (IFW15)				1	521,10		
819	64300004		THERMOSTAT IMIT LS100°C+SONDE L:3m				1	84,40		
820	65108167		FERRITE				1	35,60		
821	64211410		TRANSFORMATEUR (separateur)				1	190,80		
823	64211221		RELAIS 7A/250V-230V				1	16,90		
824	17008295		RELAIS TEMPORISE FINDER 85.02.8.240				1	151,40		
825	64211314		SUPPORT RELAIS FINDER				1	13,00		
826	64200564		INTERFACE DE COM. COCO 2				1	139,40		

1000



<b>Table</b>		<b>HABILLAGE</b>							
<i>Rep.</i>	<i>Référence</i>	<i>ALIAS</i>	<i>Désignation</i>	<i>Remplacé par</i>	<i>Date début</i>	<i>Date fin</i>	<i>Multiple de vente</i>	<i>Tarif Public Unitaire HT</i>	
1001	64201541		PANNEAU AVANT BLANC				1	279,10	
1002	64200502		SUPPORT METAL				1	18,60	
1003	65000438		PANNEAU AVANT DROIT				1	267,00	
1004	65000439		PANNEAU ARRIERE DROIT				1	198,80	
1005	64200198		PANNEAU COTE GAUCHE				1	220,90	
1006	17004115		PANNEAU AVANT BLEU				1	313,80	
1009	17016662		PANNEAU SUPERIEUR BLEU				1	555,60	
1010	65000435		PANNEAU COMMANDE BLEU				1	216,00	
1014	64201426		PANNEAU SUPERIEUR				1	200,50	
1015	65000222		COUVERCLE SUPERIEUR				1	318,40	
1016	64200830		ISOLANT 20X0.6X0.025 m				1	311,80	
1017	65107984		COUVERCLE ARRIERE				1	229,00	

5000



Table		OPTIONS							
Rep.	Référence	ALIAS	Désignation	Remplacé par	Date début	Date fin	Multiple de vente	Tarif Public Unitaire HT	
5001	64201836		SIPHON SEUL FSB				1	74,00	
5003	64921172		SONDE SPFS&KFS PLONG				1	63,90	
5004	64921173		SONDE VFAS				1	66,80	
5005	64921170		SONDE AFS EXT POUR KKM8 OU E8				1	57,10	
5010	64200600		COLLE A1312				1	242,70	
5010	64200009		SILICONE HAUTE TEMPERATURE				1	61,50	
5010	65000352		COLLE A1044				1	158,20	
5010	64210199		COLLE OMNI VISC				1	68,40	
5010	64210200		CARTOUCHE SILICONE-1001U				1	15,40	
5010	64210202		COLLE REFRACTAIRE BOITE DE 1KG				1	33,30	
5011	65001192		REPLISSAGE DE GRANULÉS PAR KG				10	8,60	
5012	64200010		PAPIER INDICATEUR PH				1	59,50	
5013	64201515		CABLAGE SONDE DEPART				1	183,90	
5014	65108162		BOITIER CONTROLE FBR2 + SONDE / KM628				1	97,80	
5015	65107921		CLE REGLAGE DE VANNE GAZ				1	213,50	
5016	65108158		RUBAN ALU ADHESIF 0.075X50m				1	99,30	
5017	65108166-01		TYRAPS 28X5 (Qt:100)				1	126,80	
5020	64901002		REGULATEUR GAZ FC06 1 1/2-DN40				1	366,80	
5021	64200885		INTERFACE PC-KM+CAVO				1	638,40	
5022	64202164		CABLE COCO E6 R500&R2900				1		
5023	12047923		TOILE SILICONE/TRAPPE 0,1X1200X1000mm				1		
5024	64201535		CONTROLEUR ETANCHEITE GAZ DUNGS VPS504				1	870,80	
5025	17016197		CONTROLEUR ETANCHEITE TC116W05T				1		
5026	17017015		JOINT DE FORME L:5M				1		
5027	64200889		SONDE RFB				1	56,40	
5028	64200996		JOINT ISOLATION 25X3mm L:1000mm (neopr.)				1		
5030	65000433		SHUNT KM628				1		
5031	64202519		DISPOSITIF DE COMMANDE LENZE				1		