

*LISTE DE PIECES*

20/06/2016

---

<i>Produit</i>	538116 - R 8180 ECS G31 50mb RACC. G.
<i>Modèle</i>	R 18
<i>Marque</i>	RENDAMAX
<i>Date</i>	22/05/2013

---

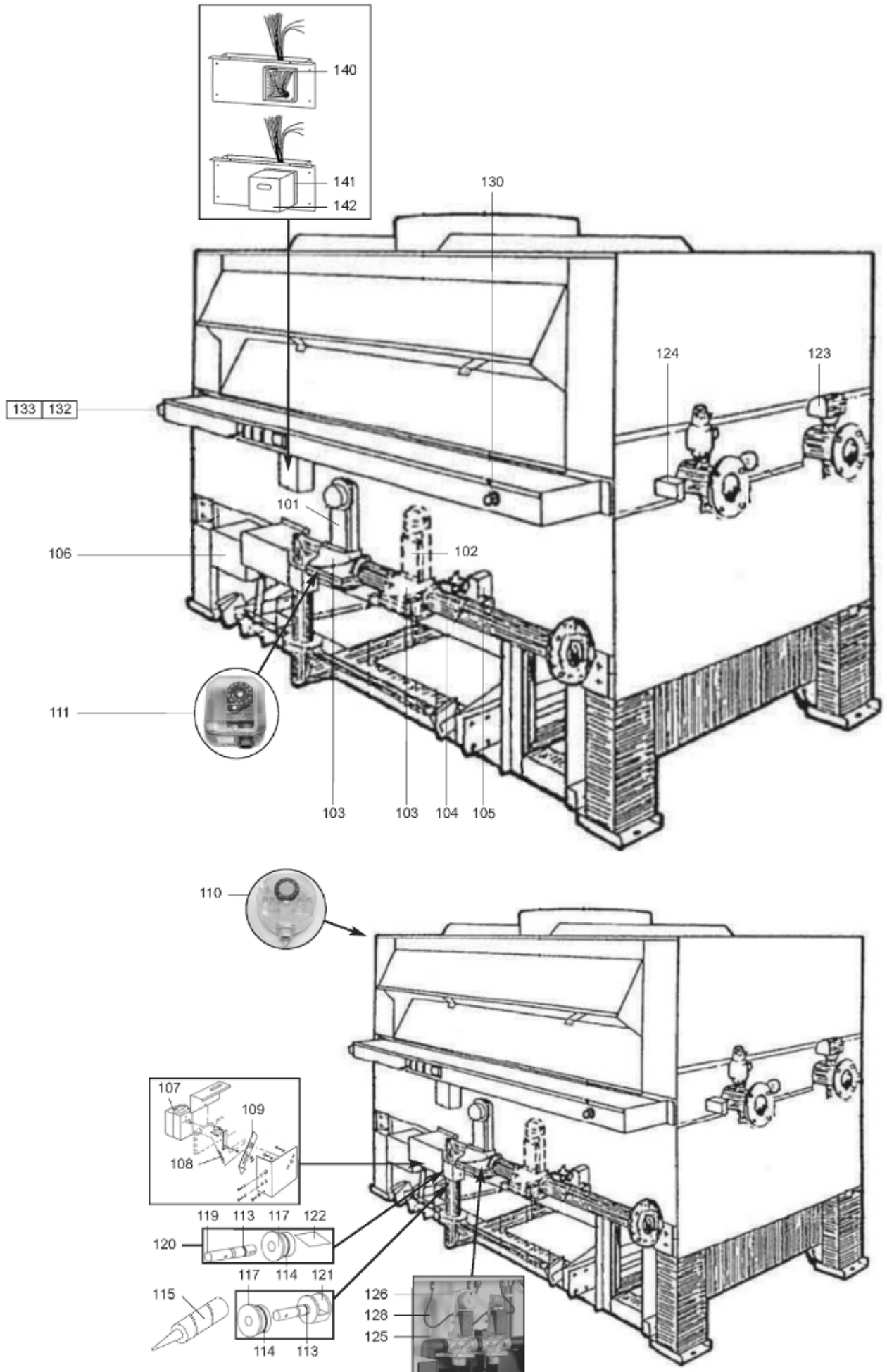

Table		PARTIE GAZ							
Rep.	Référence	ALIAS	Désignation	Remplacé par	Date début	Date fin	Multiple de vente	Tarif Public Unitaire HT	
101	64300702		SERVOMOTEUR REGULATEUR SKP 25.001E2				1	1 056,80	
101	64200092		VALVE GAZ SKP25 CONV. KIT R18/R2000				1	1 056,80	
102	64300710		SERVOMOTEUR REGULATEUR SKP 15.001E2				1	906,20	
102	64200094		SERVOMOTEUR REGULATEUR SKP 15.000E2				1	1 129,70	
103	17016179		CORPS VANNE REGULATEUR VGG10.504P				1	306,20	
104	64211210		REGULATEUR PRESSION RV 12 M				1	63,90	
105	65000265		ELECTROVANNE VEILLEUSE+CABLE				1	230,45	
106	64200089		SERVOMOTEUR REGULATEUR STM30Q15.6318				1	1 474,00	
107	64201041		KIT REMPL MOTEUR HY M644 R18				1	1 369,20	
108	17008845		RESSORT				1	16,40	
109	65108062		LEVIER / VANNE PAPILLON				1	631,40	
111	64401601		PRESSOSTAT GAZ GW 50 0 --> 50mb				1	79,00	
111	64201433		PRESSOSTAT GAZ 0-->150mb				1	176,60	
113	64210804		JOINT PLAT D:11.3-7.7-1.8(axe papil gaz)				1	3,50	
114	64210808		JOINT TORIQUE D:45.7-2.6 (support axe)				1	9,50	
115	65108157		TUBE GRAISSE MOLYKOTE BR2				1	22,20	
117	17015909		SUPPORT AXE PAPILLON 2				1	140,10	
119	64210003		AXE VANNE PAPILLON GAZ BERGER LCHAR				1	54,00	
120	17017678		ENS PAPILLON 132=>180 NAT				1	801,50	
121	64210009		PAPILLON PROP 1 1/2				1	588,00	
122	17016467		PAPILLON NAT 2				1	105,10	
123	64210205		CONTROLEUR DEBIT EAU CH 140°C				1	583,10	
123	64210206		CONTROLEUR DEBIT EAU F61-SB9100				1	223,70	
124	64300902		SONDE DEPART APPLIQUE QAD 22				1	108,70	
124	17017680		SONDE DEPART PLONGE QAE2120.010				1	216,70	
125	64211224		RACCORD BICONE DROIT 1/8 D.6				1	6,60	
125	64211226		RACCORD BICONE COUDE 1/8 D.6				1	21,40	
126	64211227		RACCORD BICONE COUDE 1/4 D.6				1	17,20	
126	64211225		RACCORD BICONE DROIT 1/4 D.6				1	13,80	
128	64211407		TUBE ALUMINIUM D:4/6 L:2m				1	123,60	
130	64300004		THERMOSTAT IMIT LS100°C+SONDE L:3m				1	84,40	
130	64211402		THERMOSTAT JUMO EMF1 0-50 C-PISCINE				1	400,70	
130	64211405		THERMOSTAT DE SECURITE 150°C				1	293,80	
132	64201537		REGULATEUR DTRON .304				1	1 294,20	
132	64201393		REGULATEUR RWF40.010 A97	64202489			1	607,80	
132	64200067		KIT REMPLACEMENT RWF31/32 par RWF40				1	607,80	
133	1758803985		ADAPTATEUR ARG40 POUR RWF40				1	48,90	
140	17007085		BLOC DIODE AGM30				1	123,30	
141	64300901		SOCLE-RELAN.LFL.AGM41049550				1	63,70	
142	64200797		COFFRET LFL 1.148				1	647,10	
142	64300804		BOITIER DE CONTROLE LFL 1.122				1	898,10	



<b>Table</b>		<b>BRULEUR</b>							
<i>Rep.</i>	<i>Référence</i>	<i>ALIAS</i>	<i>Désignation</i>	<i>Remplacé par</i>	<i>Date début</i>	<i>Date fin</i>	<i>Multiple de vente</i>	<i>Tarif Public Unitaire HT</i>	
201	64200295-01		INJECTEUR GN D:1.85mm (Qt:50)				1	158,70	
201	64210712-01		INJECTEUR PROP D:1mm (Qt:20)				1	136,50	
202	17007789		JOINT TORIQUE D:85.32-3.53				1	2,60	
203	12067690		PLAQUE PORCELAINE FACADE				1	52,60	
205	64211361		SUPPORT DE BRULEUR				1	574,10	
206	65108097		COUVERCLE COUVRE INJECTEUR				1	122,00	
207	64211209-01		BEC RAMPE BRULEUR RAYPAK (Qt:20)				1	188,50	
208	64211205		RAMPE VEILLEUSE+ELECTRODES UNIVERSEL				1	189,40	
210	65108214		FIL ALUMINIUM + CONNECTEUR ELECTRODE				1	62,70	
211	64200615		DEFLECTEUR AIR SECOND. R18 180				1	3 258,50	
212	65000455		CABLAGE ACIER INOXYDABLE D:1.5mm L:5m				1	54,10	
213	17006524		RAMPE DOUBLE DETECTION (2 IONISAT.)				1	130,00	
215	65108100		PLATEAU D'ADMISSION AIR SECONDAIRE				1	1 437,70	
216	17008405		INTERRUPTEUR BZ 2RW82-A2				1	60,50	

300

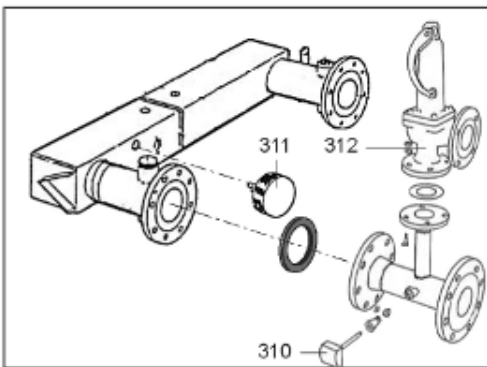

Table		ECHANGEUR							
Rep.	Référence	ALIAS	Désignation	Remplacé par	Date début	Date fin	Multiple de vente	Tarif Public Unitaire HT	
301	65108104		ECHANGEUR HAUTE T° TUV				1	8 193,10	
301	65108108		ECHANGEUR IP-PISCINE				1	8 193,10	
301	65108103		ECHANGEUR CV				1	5 847,50	
302	64201944		BAFFE SETS R18 180 STD				1	710,70	
303	65108064		COLLECTEUR DEPART HAUTE T° TUV				1	774,60	
303	65108071		COLLECTEUR DEPART IP-ZW				1	1 107,40	
303	65108067		COLLECTEUR DEPART + SUPPORT			03/06	1	622,50	
303	64200213		COLLECTEUR DEPART STD		03/06		1	816,00	
304	65108068		COLLECTEUR RETOUR + SUPPORT			03/06	1	574,90	
304	65108069		COLLECTEUR RETOUR IP-ZW				1	936,40	
304	65108065		COLLECTEUR RETOUR HAUTE T° TUV				1	774,60	
304	64200214		COLLECTEUR RETOUR STD		03/06		1	598,80	
305	65108072		COLLECTEUR LISSE IP-ZW				1	975,90	
305	65108063		COLLECTEUR LISSE HAUTE T° TUV				1	609,00	
305	65108066		COLLECTEUR LISSE + SUPPORT			03/06	1	488,20	
305	64200215		COLLECTEUR LISSE STD		03/06		1	585,60	
310	17017680		SONDE DEPART PLONGE QAE2120.010				1	216,70	
311	64210901		MANO/THERMOMETRE 0-6 BARS 120°				1	44,80	
312	17007844		SOUPAPE DE SECURITE DN32 8 BAR				1	1 116,80	
320	64201031		SUPPORT TUBE ECHANG. 154-->280				1	68,70	
321	65000455		CABLAGE ACIER INOXYDABLE D:1.5mm L:5m				1	54,10	
322	64201677		JOINTS (Pochette)				1	198,10	
322	17007778		JOINT TORIQUE D:24.99-3.53				1	4,70	
323	64211118		PLAQUE MAINTIEN JOINTS ECHANGEUR PRIM.				1	13,40	
325	64200995		JOINT PLAT D: 131-84-3				1	7,10	
326	64200919		TUBE GRAISSE SILICONE 55 g				1	124,60	

500





Table		ECHANGEUR ECS-ELECTRIQUE								
Rep.	Référence	ALIAS	Désignation	Remplacé par	Date début	Date fin	Multiple de vente	Tarif Public Unitaire HT		
502	64210409		EMBOUT COUDE ELECTRODE IONISATION				1	24,80		
503	17015694		EMBOUT COUDE ELECTRODE IONISATION				1	30,40		
505	17007316		CABLAGE IONISATION COMPL. R18				1	136,90		
506	65108203		CABLAGE 7 X 1 mm2				1	156,70		
507	64210208		CABLAGE HT EQUIPE + EMBOUT				1	24,00		
511	64201670		TRANSFORMATEUR D'ALLUMAGE				1	151,90		
512	65108190		CABLAGE TRANSFORMATEUR				1	74,30		
516	64210708		INTERRUPTEUR M/A				1	15,90		
517	64211502		VOYANT ROUGE DEFAUT				1	9,00		
519	64200883		VOYANT VERT				1	15,70		
522	17006931		PRESSOSTAT KLAUS FISCHER DS11				1	2 386,40		
531	64211221		RELAIS 7A/250V-230V				1	16,90		
532	64211314		SUPPORT RELAIS FINDER				1	13,00		
538	64211410		TRANSFORMATEUR (separateur)				1	190,80		
541	64200863		CONNECTEUR M + CABLE MOTEUR STM30				1	148,90		
542	64200870		CONNECTEUR F + CABLE MOTEUR STM30				1	148,20		
543	64200869		CABLAGE L:0.5m				1	57,40		
545	65000401		CONNECTEUR MALE 3 POLES				1	17,50		
546	64200862		CONNECTEUR M + CABLE MOT. L:0.5m				1	34,20		
547	64200861		CONNECTEUR FEMELLE 4 POLES				1	10,10		
548	64211116		CONNECTEUR 3 POLES / ALLUMAGE				1	19,60		
549	64211098		KIT CONNECTEUR R2000/R18				1	157,00		
550	64220079		FILTRE ANTIPARASITE FN670.6.06				1	130,70		
551	64210201		COMPTEUR HORAIRE 220V H 57				1	76,70		

600

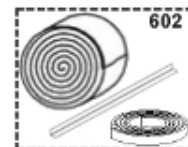

5000

5001  
Transf. gaz > B/P  
Conv. gas > LPG  
Trasf. gas > GPL  
Transf. gas > B/P  
Unrustsatz > B/P

5002  
Transf. gaz > NAT  
Conv. gas > NAT  
Trasf. gas > MET  
Transf. gas > MET  
Unrustsatz > NAT

5005  
Options  
Accessories  
Opzioni  
Accessorio  
Option

<b>Table</b>		<b>OPTIONS-MAINTENANCE</b>								
<i>Rep.</i>	<i>Référence</i>	<i>ALIAS</i>	<i>Désignation</i>	<i>Remplacé par</i>	<i>Date début</i>	<i>Date fin</i>	<i>Multiple de vente</i>	<i>Tarif Public Unitaire HT</i>		
601	65108101		KIT PIERRES D'ISOLATION				1	1 291,20		
602	65108102		KIT SUPPORT PANNEAU/PIERRE ...=>12/89			01/90	1	281,80		
603	17015502		SUPPORT PIERRE ISOLANT				1	34,20		
604	17016346		ISOLANT R18 140C				1	136,90		
607	12083849		VOYANT DE CONTROLE (FLAMME) AVEC MIROIR				1	171,30		
5001	65108099		EQT TRANSFORMATION GPL				1	899,30		
5002	65108098		EQT TRANSF > NAT				1	297,70		
5005	65108155		KIT DEMONTAGE/REMONTAGE R18				1	130,50		