

LISTE DE PIECES

20/06/2016

<i>Produit</i>	3580084 - R 2808 000
<i>Modèle</i>	R 2700 & R 2800 & R 2900
<i>Marque</i>	RENDAMAX
<i>Date</i>	10/07/2015

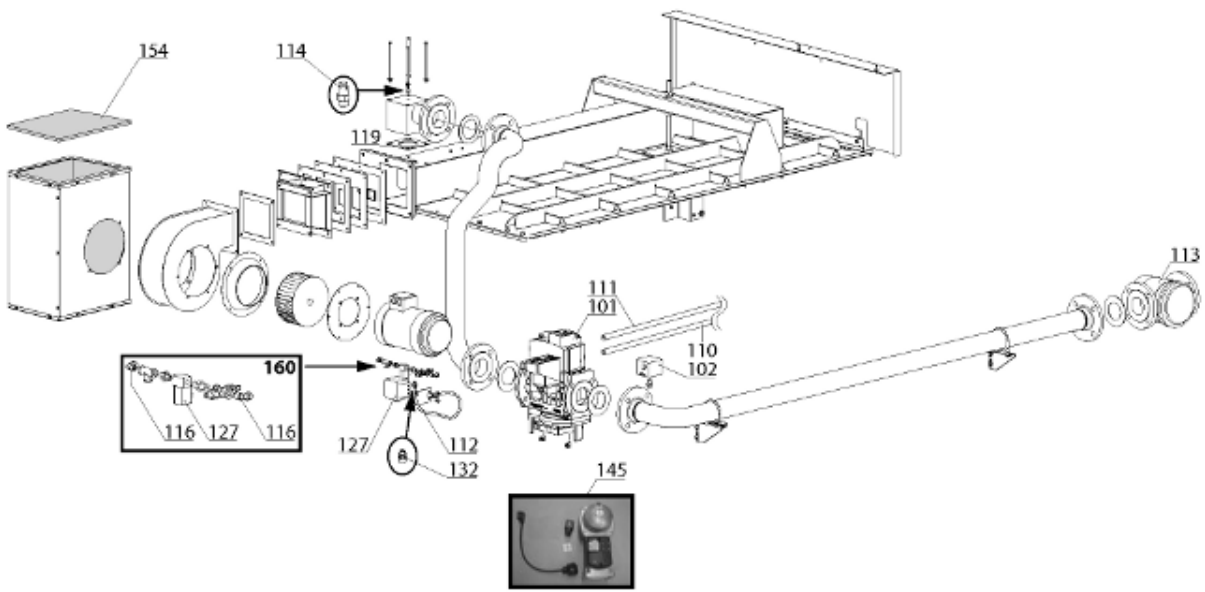

Table		PARTIE GAZ							
Rep.	Référence	ALIAS	Désignation	Remplacé par	Date début	Date fin	Multiple de vente	Tarif Public Unitaire HT	
101	64280013		VANNE GAZ DUNGS MB-VEF 420 B01 S12				1	2 559,10	
102	64401601		PRESSOSTAT GAZ GW 50 0 --> 50mb				1	79,00	
112	64280527		TUBE SOUPLE TEFLON D:6/8 L: 2M				1		
113	64280124		FILTRE GAZ				1	147,80	
114	64211101		PRISE DE PRESSION 1/8				1	2,70	
116	64200855		RACCORD COUDE 1/8 8MM				1	8,10	
116	64200854		RACCORD HAAKS 1/4 8mm				1	8,40	
119	64201306		JOINT DE FORME				1	16,40	
127	64200283		ELECTROVANNES 230V				1	173,60	
127	64200297		ELECTROVANNES 240V				1	117,60	
132	64200853		RACCORD DROIT 1/8 M				1	7,60	
145	11002083		SERVOMOTEUR SKP15.000E2 CABLE RMK040BS				1	500,80	
145	64201434		ACTIONNEUR VANNE GAZ+CABLE SKP25.303E2				1	925,80	
154	64280125		FILTRE A AIR 342X200X15				1	10,60	
160	17016093		PRESSOSTAT AIR				1		
160	17016092		PRESSOSTAT AIR				1		



Table		GROUPE VENTILATION							
<i>Rep.</i>	<i>Référence</i>	<i>ALIAS</i>	<i>Désignation</i>	<i>Remplacé par</i>	<i>Date début</i>	<i>Date fin</i>	<i>Multiple de vente</i>	<i>Tarif Public Unitaire HT</i>	
201	64280312		MOTEUR VENTILATEUR KMF T71				1	619,70	
202	64200313		TURBINE D'EXTRACTEUR				1	192,60	
203	64201291		JOINT DE FORME				1	2,40	
205	64202329		CACHE VENTILATEUR				1		
207	64201291		JOINT DE FORME				1	2,40	
208	17017147		PANNEAU RESTRICTION				1		
210	65107862		COUVERCLE SUPERIEUR				1		
211	64202491		COUVERCLE & PLAQUE DE POIDS R2909 R3600				1		
213	65000093		PRISE D'AIR + FILTRE R2789				1	555,20	
214	65107860		PRISE D'AIR CHAMBRE ETANCHE				1		

300



R8223937

Table		BLOC HYDRAULIQUE							
Rep.	Référence	ALIAS	Désignation	Remplacé par	Date début	Date fin	Multiple de vente	Tarif Public Unitaire HT	
301	64210206		CONTROLEUR DEBIT EAU F61-SB9100				1	223,70	
302	64211228		ROBINET 1/2 (VANNE VIDANGE)				1	36,80	
304	64201239		SOUPAPE SECURITE 3 BARS 1-1/2				1	361,10	
304	64211303		SOUPAPE SECURITE 3 BARS 1 1/4				1	134,20	
305	64280522		SONDE DC (/ KM 628)				1	41,90	
306	65000459		MANOMETRE 0-10 BARS				1	202,40	
306	64210903		MANOMETRE 0-4 BARS				1	32,20	
306	64201240		MANOMETRE 0-6 BARS				1	131,50	
306	64200087		RACCORD / MANOMETRE 0-->4 bars				1	24,00	
308	64201241		PRESSOSTAT SDBRAM (MAX)				1	590,20	
309	64201242		PRESSOSTAT HUBA 625.9978 (MIN)				1	130,70	
311	4478694220		DOIGT DE GANT R9/R18				1		
314	64200512		JOINT PLAT D:95-58-3				1	13,60	
316	64200998		JOINT PLAT D: 115-77-3				1	9,10	
317	12083849		VOYANT DE CONTROLE (FLAMME) AVEC MIROIR				1	171,30	
318	65108160		TUYAU DE SIPHON 1/2				1	86,10	
321	64280467		RACCORD BICONE DROIT 1/8 D.8				1	14,00	
324	65107865		KIT GARNITURE				1		
325	64200511		JOINT 25X5X25000 mm PTFE				1		
326	65108209		RACCORD 1/8 D.8				1	15,40	
327	65108213		TUBE CUIVRE 6X8 mm L:2m				1	149,00	

400



Table		RAMPE GAZ							
<i>Rep.</i>	<i>Référence</i>	<i>ALIAS</i>	<i>Désignation</i>	<i>Remplacé par</i>	<i>Date début</i>	<i>Date fin</i>	<i>Multiple de vente</i>	<i>Tarif Public Unitaire HT</i>	
401	65107861		PLAQUE PREMELANGEUSE				1		
402	12038386		JOINT DE FORME				1	210,50	
402	64201298		JOINT DE FORME				1	63,20	
403	64201298		JOINT DE FORME				1	63,20	
405	65108146		RESSORT DE PRESSION (10pcs)				1	32,10	
407	12016166		JOINT 12X3X20000 mm NEOPR.				1		
408	65107865		KIT GARNITURE				1		
409	64200511		JOINT 25X5X25000 mm PTFE				1		



Table		BRULEUR							
<i>Rep.</i>	<i>Référence</i>	<i>ALIAS</i>	<i>Désignation</i>	<i>Remplacé par</i>	<i>Date début</i>	<i>Date fin</i>	<i>Multiple de vente</i>	<i>Tarif Public Unitaire HT</i>	
501	64200216		ECHANGEUR BRULEUR R2808				1	4 920,40	
502	64202264		ELECTRODE ALLUMAGE + JOINT				1	47,50	
503	64201562		ELECTRODE IONISATION				1	57,00	
504	64200325		JOINT DE FORME				1	4,00	
505	17010022		RACCORD M F				1	18,10	



Table		ECHANGEUR							
<i>Rep.</i>	<i>Référence</i>	<i>ALIAS</i>	<i>Désignation</i>	<i>Remplacé par</i>	<i>Date début</i>	<i>Date fin</i>	<i>Multiple de vente</i>	<i>Tarif Public Unitaire HT</i>	
601	64201264		1er ECHANGEUR (tubes lisses)				1	4 608,30	
602	64201274		ECHANGEUR 2 (tubes ailettes)				1	9 560,90	
606	64200998		JOINT PLAT D: 115-77-3				1	9,10	
607	4968707355		ISOLANT BLANC 14.64X0.013X0.085m				1	158,30	
608	64200834		ISOLANT 420X15X15mm				1	149,80	
609	64200830		ISOLANT 20X0.6X0.025 m				1	311,80	
610	64200817		ISOLANT 751X152X10mm				1	169,10	
611	64200284		ISOLANT 780X152X25mm				1	179,00	
612	64200815		ISOLANT LATERAL L:5m 50X5mm				1	131,80	
613	12039299		ISOLANT 780X116X25mm				1	138,40	

700



Table		ECHANGEURS							
<i>Rep.</i>	<i>Référence</i>	<i>ALIAS</i>	<i>Désignation</i>	<i>Remplacé par</i>	<i>Date début</i>	<i>Date fin</i>	<i>Multiple de vente</i>	<i>Tarif Public Unitaire HT</i>	
701	64202276		JOINT ISOLATION 25X3mm L:20m (neopr.)				1	188,70	
702	64200436		JOINT L:5m				1		
703	4148707742		COUVERCLE D'INSPECTION COMPLET				1	394,70	
703	6100055		INSPECTION BLIND HATCH COMPLETE				1	296,10	
706	64211228		ROBINET 1/2 (VANNE VIDANGE)				1	36,80	
710	65107863		RECUPERATEUR DE CONDENSAT				1		
712	65107864		BASE DE CHEMINEE				1		
717	64200822		PIEDS COMPLET (Qt:4)				1	184,60	

800



Table		BOITIER ELECTRIQUE							
Rep.	Référence	ALIAS	Désignation	Remplacé par	Date début	Date fin	Multiple de vente	Tarif Public Unitaire HT	
801	64201884		CABLAGE ELECTR. ALLU.				1		
802	64210409		EMBOUT COUDE ELECTRODE IONISATION				1	24,80	
803	64202438		TRANSFORMATEUR 220V / KM628				1	141,90	
804	64200873		VARIATEUR DE FREQUENCE 8201-E				1	884,50	
805	65000230		BOITIER DE COMMANDE KM628				1	777,00	
805	64202435		SET CONNECTEURS KM628				1		
806	64201641		TRANSFORMATEUR ALLUMAGE+CABLE 2P				1	119,20	
807	64200294		INTERRUPTEUR				1	38,10	
808	64202260		CONNECTEUR M (KIT) pour 64280310				1	119,70	
808	64280310		CIRCUIT IMPRIME CXE				1	438,80	
809	64201439		FILTRE ANTIPARASITE				1	200,50	
810	64201538		RELAIS ALAN BRADLEY 100-K09-KF10				1	89,30	
810	64201539		RELAIS 100-K09KF10 & 193-K40 (A&B)				1	260,00	
811	64201300		CABLAGE ELECTRODE IONISATION				1	134,90	
812	64280407		PRESSOSTAT DIFFERENTIEL				1	109,10	
813	65000251		MODULE DE GESTION KKM8				1	921,50	
813	65000252		REGULATEUR DE CHAUF (TYPE E8)				1	533,60	
813	64200788		MODULE CLIMATIQUE BM8				1	560,30	
814	64210410		EMBOUT ELECTRODE HT				1	21,20	
819	64300004		THERMOSTAT IMIT LS100°C+SONDE L:3m				1	84,40	
820	65108167		FERRITE				1	35,60	
821	64211410		TRANSFORMATEUR (separateur)				1	190,80	
823	64211221		RELAIS 7A/250V-230V				1	16,90	
824	17008295		RELAIS TEMPORISE FINDER 85.02.8.240				1	151,40	
825	64211314		SUPPORT RELAIS FINDER				1	13,00	
826	64200564		INTERFACE DE COM. COCO 2				1	139,40	

5000

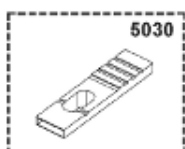
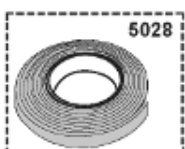
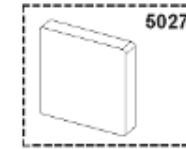
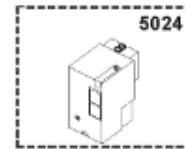
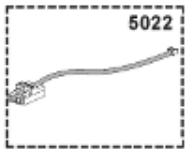
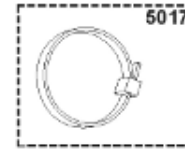
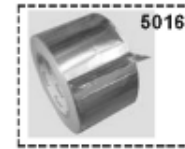

Table		OPTIONS							
Rep.	Référence	ALIAS	Désignation	Remplacé par	Date début	Date fin	Multiple de vente	Tarif Public Unitaire HT	
5001	64201836		SIPHON SEUL FSB				1	74,00	
5003	64921172		SONDE SPFS&KFS PLONG				1	63,90	
5004	64921173		SONDE VFAS				1	66,80	
5005	64921170		SONDE AFS EXT POUR KKM8 OU E8				1	57,10	
5010	64200600		COLLE A1312				1	242,70	
5010	65000352		COLLE A1044				1	158,20	
5010	64200009		SILICONE HAUTE TEMPERATURE				1	61,50	
5010	64210199		COLLE OMNI VISC				1	68,40	
5010	64210200		CARTOUCHE SILICONE-1001U				1	15,40	
5010	64210202		COLLE REFRACTAIRE BOITE DE 1KG				1	33,30	
5011	65001192		REPLISSAGE DE GRANULÉS PAR KG				10	8,60	
5012	64200010		PAPIER INDICATEUR PH				1	59,50	
5013	64201515		CABLAGE SONDE DEPART				1	183,90	
5014	65108162		BOITIER CONTROLE FBR2 + SONDE / KM628				1	97,80	
5016	65108158		RUBAN ALU ADHESIF 0.075X50m				1	99,30	
5017	65108166-01		TYRAPS 28X5 (Qt:100)				1	126,80	
5021	64200885		INTERFACE PC-KM+CAVO				1	638,40	
5022	64202164		CABLE COCO E6 R500&R2900				1		
5023	12047923		TOILE SILICONE/TRAPPE 0,1X1200X1000mm				1		
5024	64201535		CONTROLEUR ETANCHEITE GAZ DUNGS VPS504				1	870,80	
5026	17017015		JOINT DE FORME L:5M				1		
5027	64200889		SONDE RFB				1	56,40	
5028	64202276		JOINT ISOLATION 25X3mm L:20m (neopr.)				1	188,70	
5030	65000433		SHUNT KM628				1		