

LISTE DE PIECES

05/07/2016

<i>Produit</i>	3080082 - HYDRA 70 IS RENDAMAX
<i>Modèle</i>	HYDRA
<i>Marque</i>	RENDAMAX
<i>Date</i>	19/06/2013

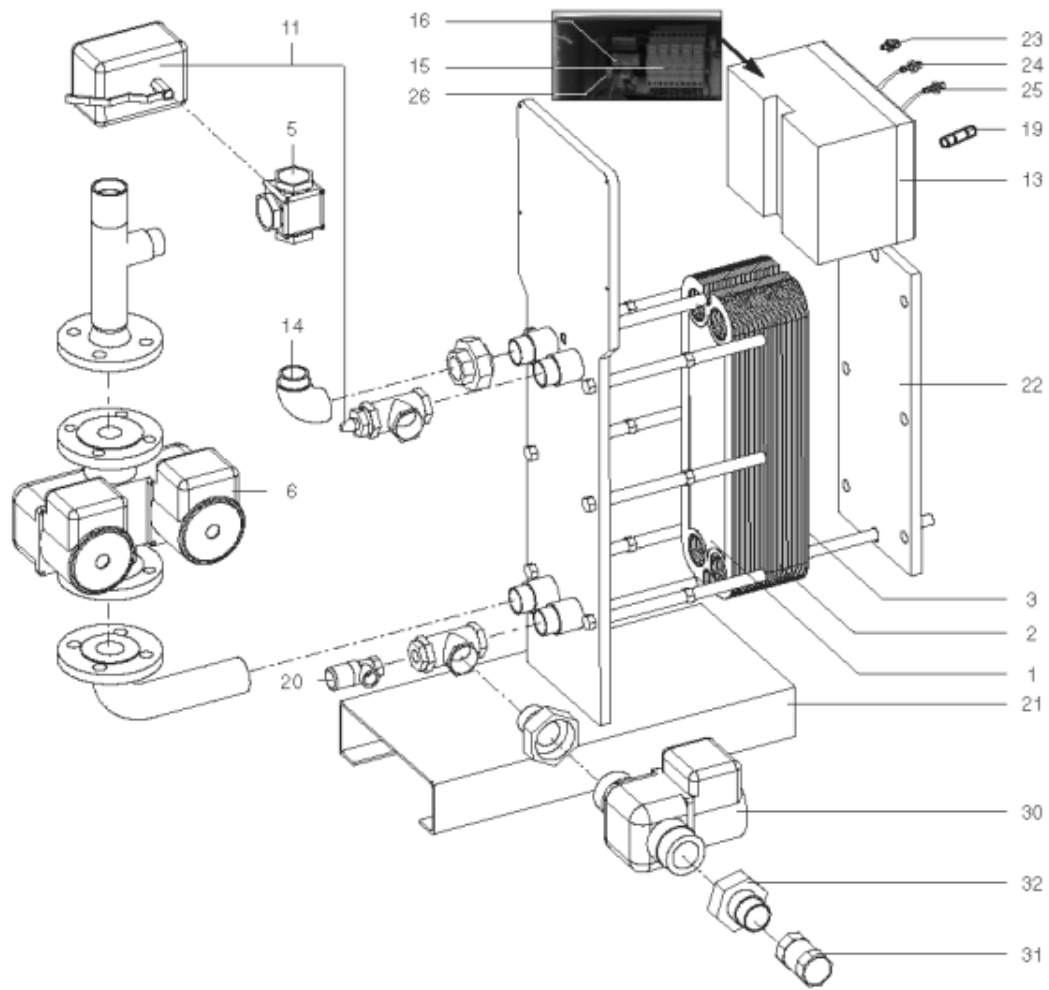

Table		HYDRA 01/2005 > ...								
Rep.	Référence	ALIAS	Désignation	Remplacé par	Date début	Date fin	Multiple de vente	Tarif Public	Unitaire	HT
1	61400975		PLAQUE INOX 4 OUVERTURES 45.5X14.2 cm				1	278,60		
2	61400974		PLAQUE INOX INTERMEDIAIRE 45.5X14.2 cm				1	292,50		
3	61400976		PLAQUE INOX PLEINE 45.5X14.2 cm				1	284,00		
5	61400981		VANNE 3 VOIES LAITON DN32 11/4 (ESBE)				1	257,70		
6	61400977		POMPE SIMPLE DE 70 > 210KW				1	791,70		
11	61400983		SERVOMOTEUR REGULATEUR (ESBE)				1	2 249,50		
13	61400973		COFFRET ELECTRIQUE 240V HYDRA 1				1	1 381,90		
14	61400982		COUDE UNION PRIMAIRE				1	147,10		
15	60001193		PORTE FUSIBLE				1	19,10		
16	60001655		TRANSFORMATEUR 220/24V 25VA				1	176,60		
19	60001656		FUSIBLE 1A 10X38 AM				1	6,60		
19	60001657		FUSIBLE 2A gG 10X38				1	6,60		
19	60001658		FUSIBLE 500mA 5X20				1	6,60		
20	61400984		SOUPAPE DE SECURITE 7 BARS				1	126,10		
21	61400988		SUPPORT GAUCHE				1	938,90		
22	61400989		SUPPORT DROIT				1	163,50		
23	60000479		BOUTON POUSSOIR				1	35,50		
24	60000480		VOYANT ROUGE				1	57,00		
25	60000481		VOYANT VERT				1	57,00		
26	60001659		RELAIS RCL 424730 220V 2RT				1	19,80		
30	60000066		POMPE SIMPLE BRONZE (G1.5)				1	1 510,80		
31	60000071		CLAPET ANTI-RETOUR				1	141,80		
32	60000072		RACCORD G 1.5				1	192,90		