

LISTE DE PIECES

05/07/2016

<i>Produit</i>	538229 - R 306 PISCINE G20 300mb
<i>Modèle</i>	R300
<i>Marque</i>	RENDAMAX
<i>Date</i>	19/06/2006

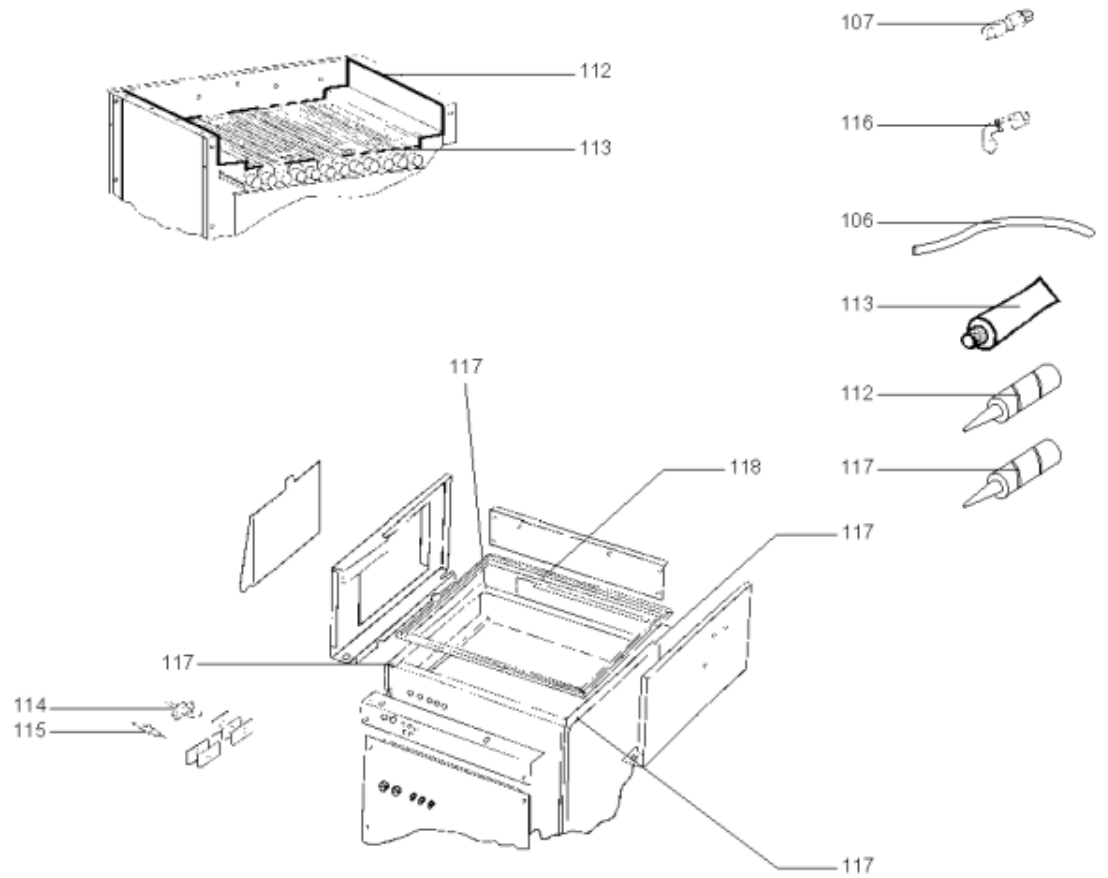
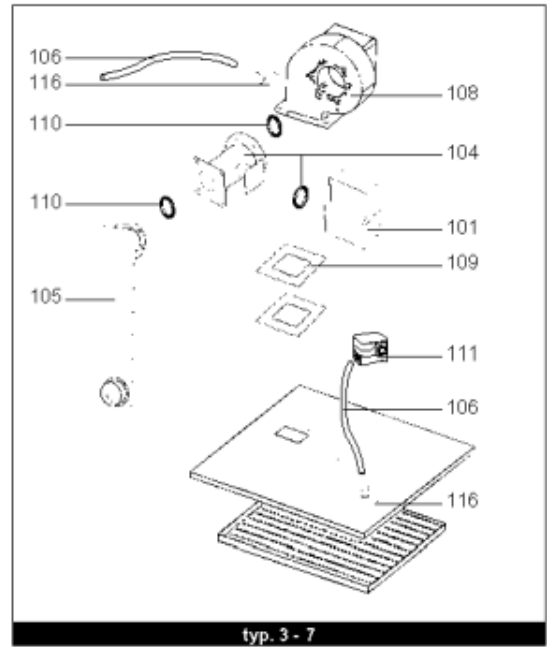
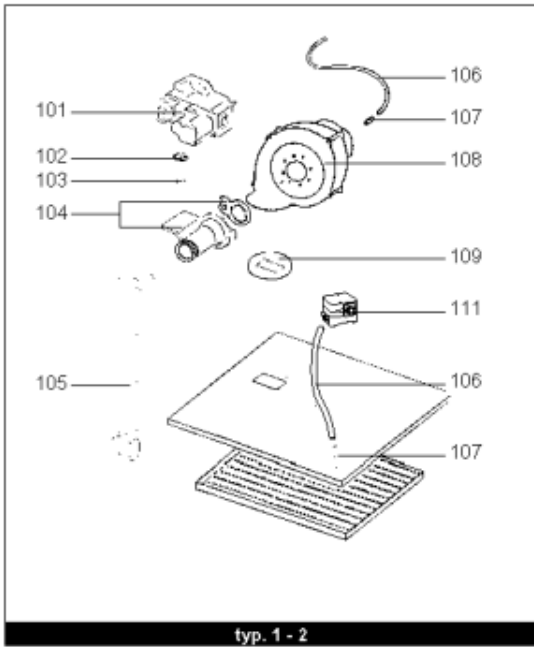

Table		PARTIE GAZ							
Rep.	Référence	ALIAS	Désignation	Remplacé par	Date début	Date fin	Multiple de vente	Tarif Public Unitaire HT	
101	65000259		VANNE GAZ 305/307 507/507				1	858,30	
101	64280007		VANNE GAZ CG25R03 VW6CZ (R305 & 306)				1	1 357,50	
104	64201524		VENTURI + JOINT (R305-R307/R506-R507)				1	355,80	
108	65000320		VENTILATEUR G1G170				1	1 035,70	
109	65000483		JOINT DE FORME				1	9,10	
109	64200983		JOINT DE FORME				1	8,30	
111	64280407		PRESSOSTAT DIFFERENTIEL				1	109,10	
112	64200009		SILICONE HAUTE TEMPERATURE				1	61,50	
113	64210199		COLLE OMNI VISC				1	68,40	
114	64202263		ELECTRODE ALLUMAGE + JOINT				1	50,30	
115	64201562		ELECTRODE IONISATION				1	57,00	
116	64200855		RACCORD COUDE 1/8 8MM				1	8,10	
117	64200009		SILICONE HAUTE TEMPERATURE				1	61,50	
118	12016166		JOINT 12X3X20000 mm NEOPR.				1		

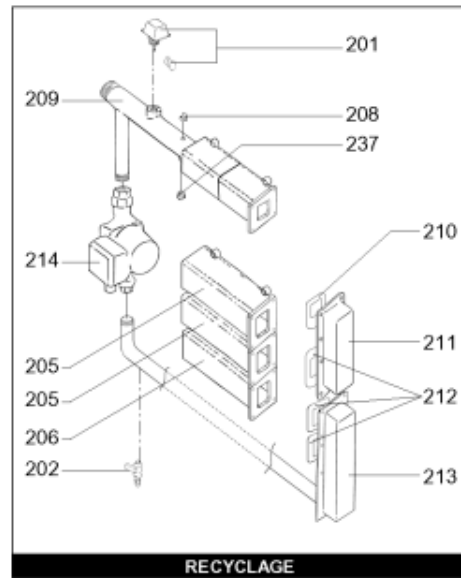
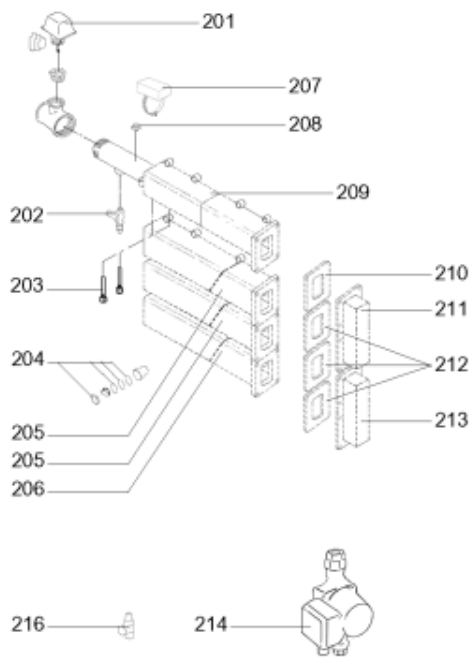
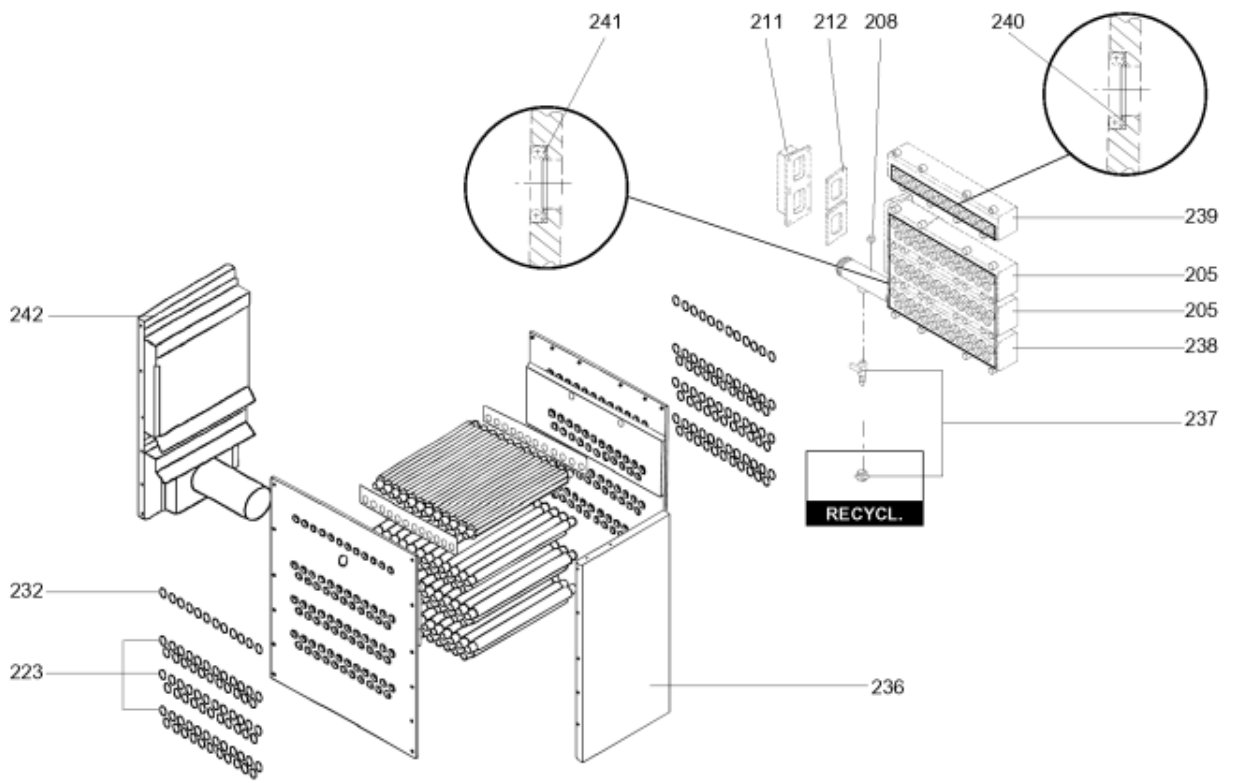

Table		BLOC HYDRAULIQUE							
<i>Rep.</i>	<i>Référence</i>	<i>ALIAS</i>	<i>Désignation</i>	<i>Remplacé par</i>	<i>Date début</i>	<i>Date fin</i>	<i>Multiple de vente</i>	<i>Tarif Public Unitaire HT</i>	
201	64201474		CONTROLEUR DEBIT EAU				1	607,10	
202	64211228		ROBINET 1/2 (VANNE VIDANGE)				1	36,80	
203	64200061		GAINÉ THERMOSTAT 1/4 7.2				1	74,80	
204	64200929		HUBLLOT (Pochette)				1	171,90	
204	12083849		VOYANT DE CONTROLE (FLAMME) AVEC MIROIR				1	171,30	
205	65108043		COLLECTEUR DE DISTRIBUTION				1	784,00	
206	65108043		COLLECTEUR DE DISTRIBUTION				1	784,00	
207	64921173		SONDE VFAS				1	66,80	
208	12084575		SONDE FUMÉE				1	60,98	
209	65108036		COLLECTEUR				1	1 117,90	
210	64200986		JOINT DE FORME				1	13,10	
211	65107996		CONNECTEUR				1	266,20	
212	64200984		JOINT DE FORME				1	5,20	
213	65107997		RACCORD				1	249,30	
214	64201234		POMPE C0M350/11 230V				1	1 804,30	
223	65000351		COLLE LH197				1	160,50	

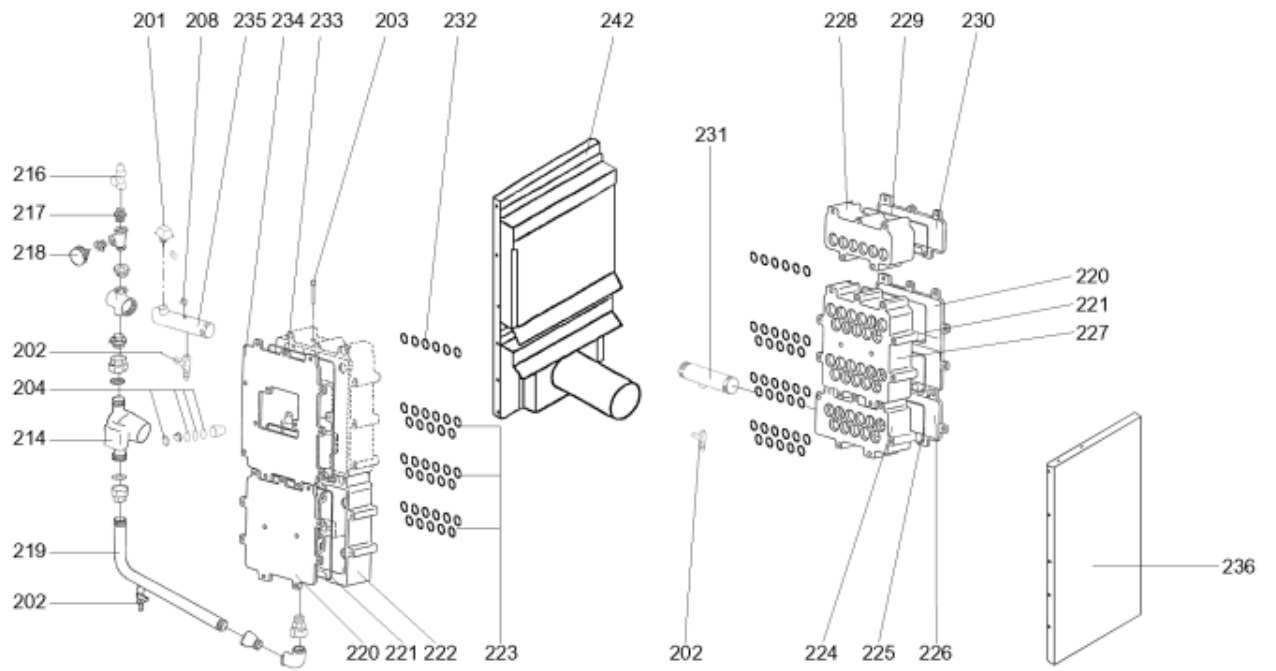

Table		BLOC HYDRAULIQUE (SUITE)							
<i>Rep.</i>	<i>Référence</i>	<i>ALIAS</i>	<i>Désignation</i>	<i>Remplacé par</i>	<i>Date début</i>	<i>Date fin</i>	<i>Multiple de vente</i>	<i>Tarif Public Unitaire HT</i>	
201	64201474		CONTROLEUR DEBIT EAU				1	607,10	
202	64211228		ROBINET 1/2 (VANNE VIDANGE)				1	36,80	
203	64200061		GAIN THERMOSTAT 1/4 7.2				1	74,80	
204	64200929		HUBLOT (Pochette)				1	171,90	
204	12083849		VOYANT DE CONTROLE (FLAMME) AVEC MIROIR				1	171,30	
208	12084575		SONDE FUMEE				1	60,98	
214	64201234		POMPE COM350/11 230V				1	1 804,30	
223	65000351		COLLE LH197				1	160,50	

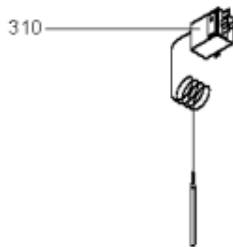
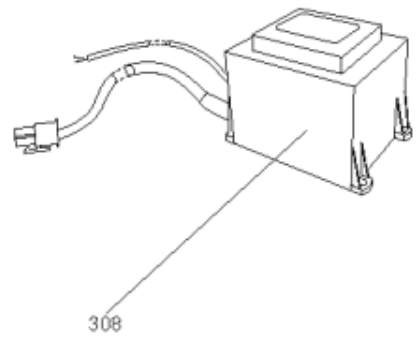
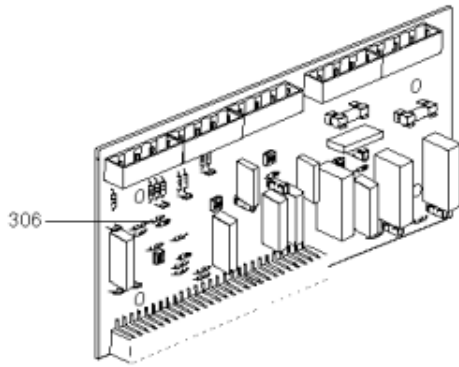
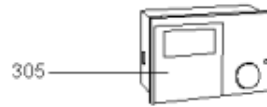
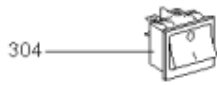
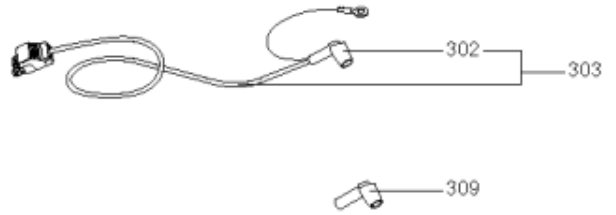
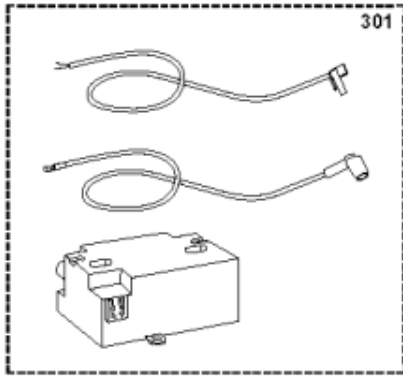

Table		BOITIER ELECTRIQUE							
<i>Rep.</i>	<i>Référence</i>	<i>ALIAS</i>	<i>Désignation</i>	<i>Remplacé par</i>	<i>Date début</i>	<i>Date fin</i>	<i>Multiple de vente</i>	<i>Tarif Public Unitaire HT</i>	
301	64201641		TRANSFORMATEUR ALLUMAGE+CABLE 2P				1	119,20	
302	64210409		EMBOUT COUDE ELECTRODE IONISATION				1	24,80	
303	12067866		CABLE DE BOUGIE COUDE L:0.15m				1	84,60	
304	64200294		INTERRUPTEUR				1	38,10	
305	65108204		CABLAGE ELECTRODE IONISATION				1	138,90	
306	64280310		CIRCUIT IMPRIME CXE				1	438,80	
306	64202260		CONNECTEUR M (KIT) pour 64280310				1	119,70	
308	64202438		TRANSFORMATEUR 220V / KM628				1	141,90	
309	64210410		EMBOUT ELECTRODE HT				1	21,20	

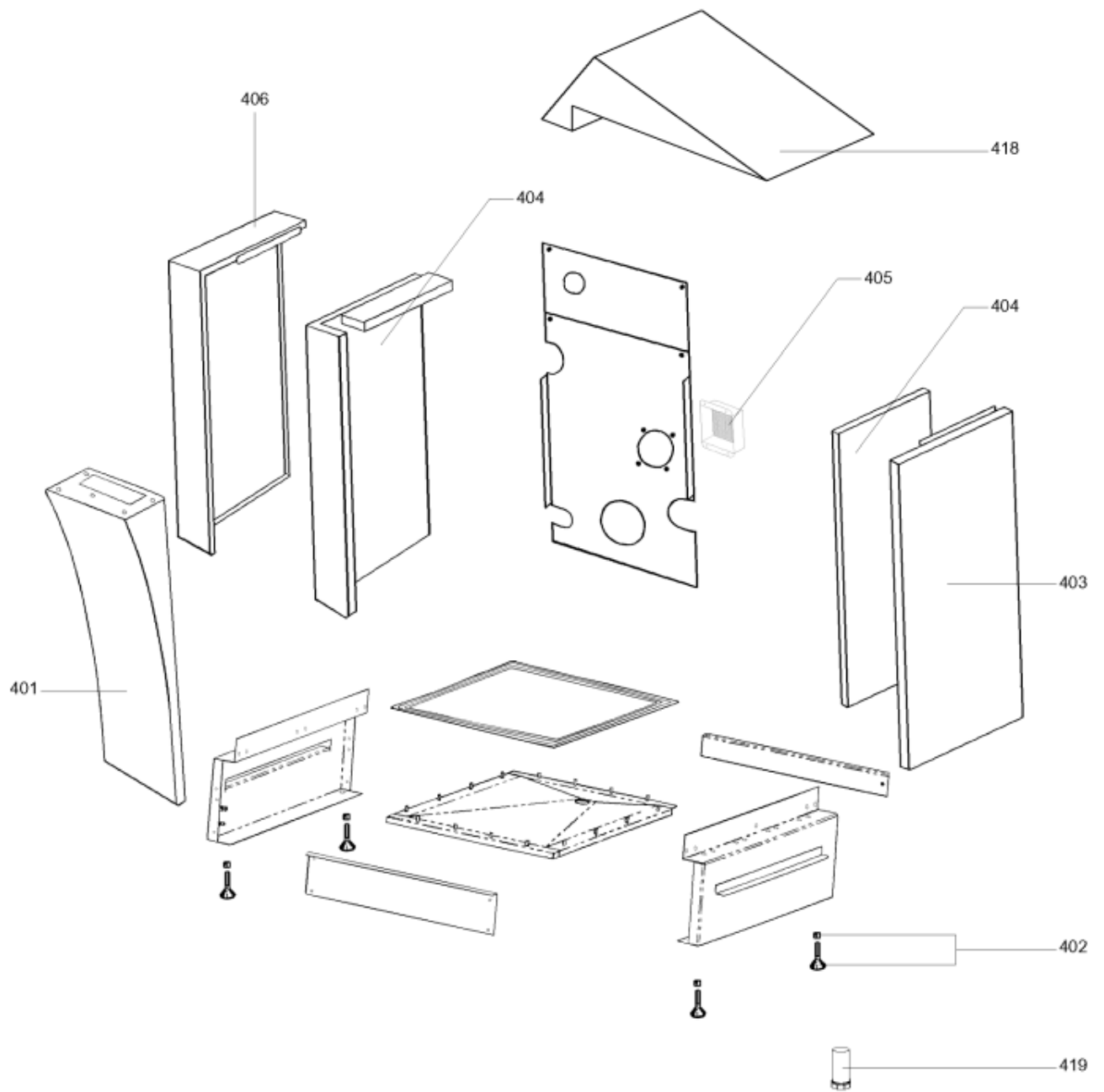

Table		HABILLAGE							
<i>Rep.</i>	<i>Référence</i>	<i>ALIAS</i>	<i>Désignation</i>	<i>Remplacé par</i>	<i>Date début</i>	<i>Date fin</i>	<i>Multiple de vente</i>	<i>Tarif Public Unitaire HT</i>	
401	64200499		JOINT DE FORME BAC A CONDENSAT				1	136,50	
402	64200820		PIED RÉGLABLE M12X106				1	50,40	
403	65108048		RECUPERATEUR DE CONDENSAT				1	638,10	
404	64201836		SIPHON SEUL FSB				1	74,00	
405	64210700		ISOLANT (L5m) / antirefou.&volet d'air				1	264,50	
406	17004742		GARNITURE CHEMINEE 80mm SILICON				1	35,90	