

LISTE DE PIECES

05/07/2016

<i>Produit</i>	3087272 - SUN COMPACT 100 TB-2V
<i>Modèle</i>	SUN COMPACT
<i>Marque</i>	NEUTRO
<i>Date</i>	15/05/2012

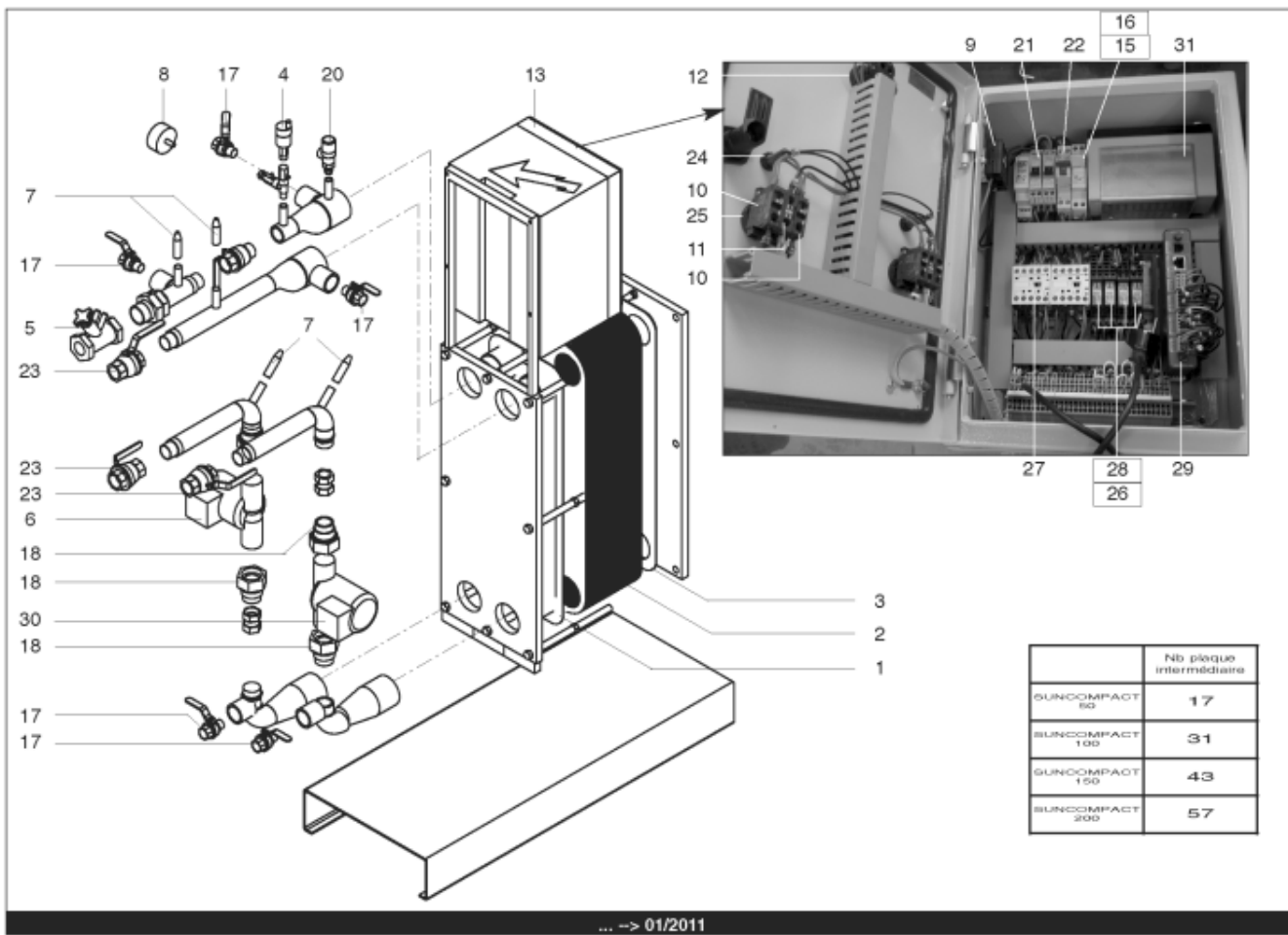

	Nb plaque intermédiaire
SUNCOMPACT 50	17
SUNCOMPACT 100	31
SUNCOMPACT 150	43
SUNCOMPACT 200	57

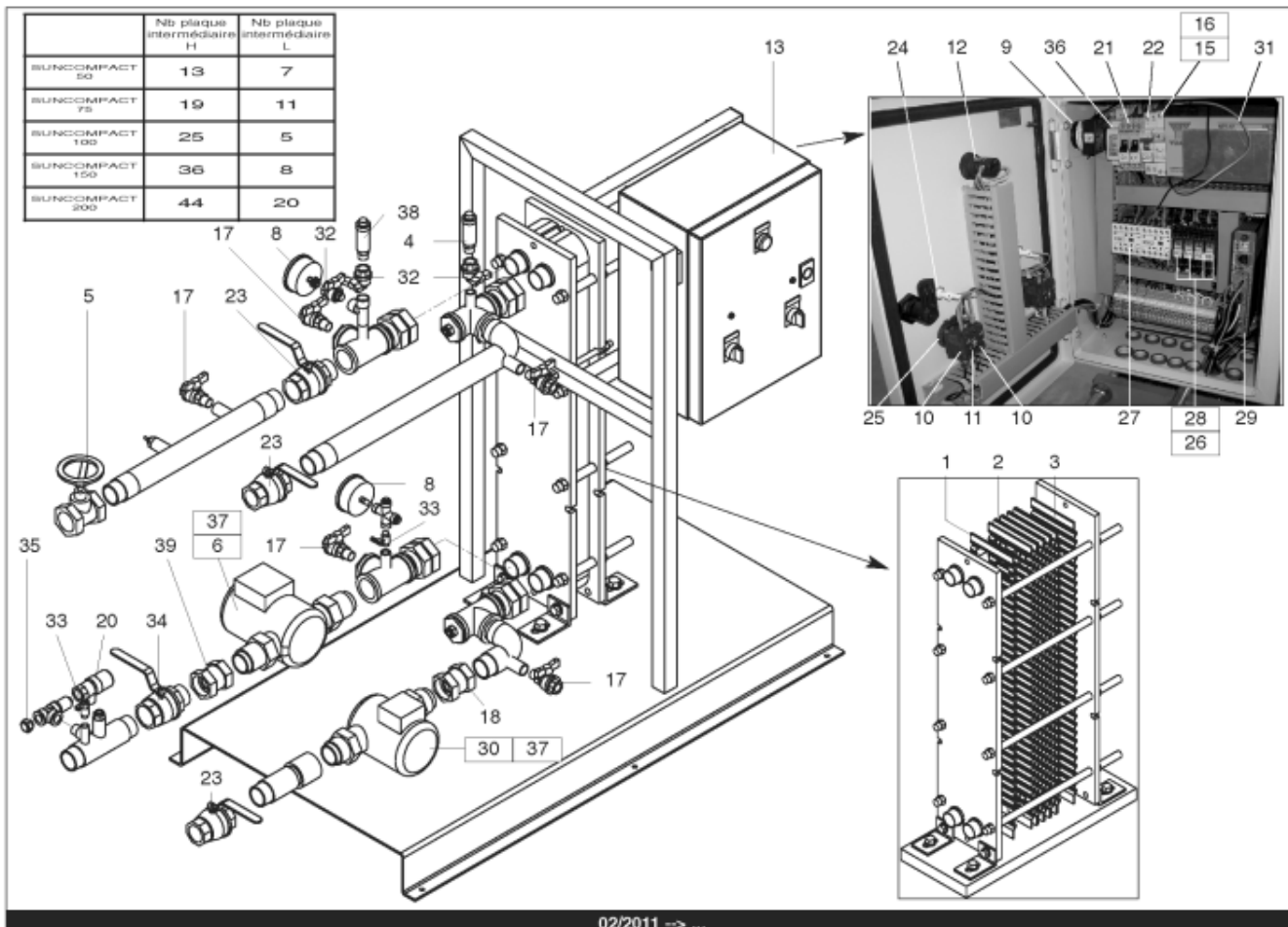

Table		SUN COMPACT								
Rep.	Référence	ALIAS	Désignation	Remplacé par	Date début	Date fin	Multiple de vente	Tarif Public Unitaire HT		
1	60001662		PLAQUE PGT42 INITIALE (4trous) 72.5X24			02/11	1	110,60		
1	60001724		PLAQUE INITIALE (4trous) 64X18cm		02/11		1	83,80		
2	60001661		PLAQUE PGT42 INTERMEDIAIRE 72.5x24			02/11	1	110,60		
2	60001725		PLAQUE INTERMEDIAIRE H (64X18cm)		02/11		1	87,00		
2	60001726		PLAQUE INTERMEDIAIRE L (64X18cm)		02/11		1	83,80		
3	60001663		PLAQUE PGT42 FINALE (pleine) 72.5X24			02/11	1	110,60		
3	60001727		PLAQUE FINALE (pleine) 64X18cm		02/11		1	83,80		
4	60001672		PURGEUR AUTOMATIQUE				1	30,30		
5	60001674		ROBINET REGLABLE DN32				1	99,00		
6	60001664		POMPE ROUGE UPS 32-80	60001740		02/11	1	856,40		
6	60001735		POMPE TP 32-90 BQQE		02/11		1	1 968,50		
6	60001737		POMPE TPD 32-80 BQQE		02/11		1	5 901,60		
7	60001670		SONDE / DOIGT DE GANT				1	80,30		
8	60001671		MANOMETRE 0-->10 Bars Hrz				1	99,40		
9	60001676		INTERRUPTEUR ON/OFF MONO				1	80,30		
10	60001678		CONTACTEUR NO 3-4				1	61,70		
11	60001679		SUPPORT VOYANT VERT DEL 220V				1	61,70		
12	60001681		VOYANT BLANC 220V				1	31,50		
13	60001675		BOITIER ELECTRIQUE				1	202,50		
15	60001193		PORTE FUSIBLE				1	19,10		
16	60001689		FUSIBLE 1A gG 10X38				1	12,30		
17	60001688		ROBINET DN 20 FF 20/27			02/11	1	18,70		
17	60001728		ROBINET 15 MF 15/21		02/11		1	18,70		
18	60001669		RACCORD ANTI-RETOUR SOCLA DN 32				1	80,30		
20	60001673		SOUPAPE DE SECURITE 7 BARS				1	99,00		
21	60001682		DISJONCTEUR 2A				1	61,70		
22	60001683		DISJONCTEUR 10A				1	74,50		
23	60001668		ROBINET DN 32 FF 33/42				1	31,50		
24	60001680		VOYANT ROUGE 220V				1	61,70		
25	60001677		VOYANT POUSSOIR VERT				1	61,70		
26	60001659		RELAIS RCL 424730 220V 2RT				1	19,80		
27	60001684		CONTACTEUR 230V				1	82,70		
28	60001685		SUPPORT RELAIS SRC-1 2RT				1	12,90		
29	60001686		BOITIER CONNECTION T BOX (3087261)				1	2 444,70		
30	60001665		POMPE SIMPLE NOIR TP 25-50			02/11	1	1 556,00		
30	60001667		POMPE DOUBLE TPD 32-60 BUBE			02/11	1	2 560,30		
30	60001742		POMPE TPD 32-60 BUBE	60001667	02/11		1	2 560,30		
31	60001687		MODULE D'ALIMENTATION				1	428,20		
32	60001729		ROBINET 10 MF 12/17				1	18,70		
33	60001730		ROBINET				1	6,40		
34	60001731		ROBINET 32 MF 33/42				1	21,00		
35	60001732		BOUCHON M 15/21				1	4,50		
36	60001733		TRANSFORMATEUR				1	244,40		
37	60001744		POMPE TP 32-90 BUBE				1	1 765,00		
38	60001745		PURGEUR				1	69,90		
39	60001746		RACCORD ANTI-RETOUR				1	143,20		