

LISTE DE PIECES

20/06/2016

| | |
|----------------|--------------------------|
| <i>Produit</i> | 3580109 - R 2906 BME |
| <i>Modèle</i> | R 2700 & R 2800 & R 2900 |
| <i>Marque</i> | RENDAMAX |
| <i>Date</i> | 10/07/2015 |

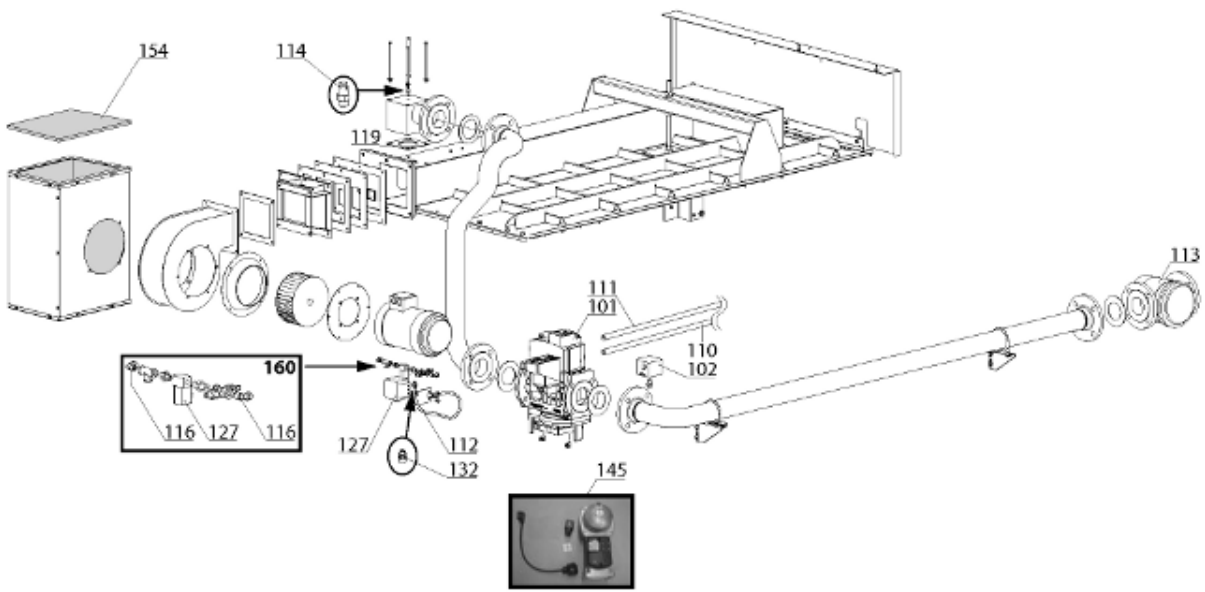

| Table | | PARTIE GAZ | | | | | | | |
|-------|-----------|------------|--|--------------|------------|----------|-------------------|--------------------------|--|
| Rep. | Référence | ALIAS | Désignation | Remplacé par | Date début | Date fin | Multiple de vente | Tarif Public Unitaire HT | |
| 101 | 64200110 | | VANNE GAZ DUNGS MB-VEF 415 S12 | | | | 1 | 2 470,60 | |
| 102 | 64401601 | | PRESSOSTAT GAZ GW 50 0 --> 50mb | | | | 1 | 79,00 | |
| 112 | 64280527 | | TUBE SOUPLE TEFLON D:6/8 L: 2M | | | | 1 | | |
| 113 | 64280124 | | FILTRE GAZ | | | | 1 | 147,80 | |
| 113 | 64280123 | | FILTRE GAZ GFK40R10RP1 1/2 | | | | 1 | 198,50 | |
| 114 | 64211101 | | PRISE DE PRESSION 1/8 | | | | 1 | 2,70 | |
| 116 | 64200854 | | RACCORD HAAKS 1/4 8mm | | | | 1 | 8,40 | |
| 116 | 64200855 | | RACCORD COUDE 1/8 8MM | | | | 1 | 8,10 | |
| 119 | 64201306 | | JOINT DE FORME | | | | 1 | 16,40 | |
| 127 | 64200283 | | ELECTROVANNES 230V | | | | 1 | 173,60 | |
| 127 | 64200297 | | ELECTROVANNES 240V | | | | 1 | 117,60 | |
| 132 | 64200853 | | RACCORD DROIT 1/8 M | | | | 1 | 7,60 | |
| 145 | 64201434 | | ACTIONNEUR VANNE GAZ+CABLE SKP25.303E2 | | | | 1 | 925,80 | |
| 145 | 11002083 | | SERVOMOTEUR SKP15.000E2 CABLE RMK040BS | | | | 1 | 500,80 | |
| 154 | 64280125 | | FILTRE A AIR 342X200X15 | | | | 1 | 10,60 | |
| 160 | 17016093 | | PRESSOSTAT AIR | | | | 1 | | |
| 160 | 17016092 | | PRESSOSTAT AIR | | | | 1 | | |



| Table | | GROUPE VENTILATION | | | | | | | |
|--------------|------------------|---------------------------|---|---------------------|-------------------|-----------------|--------------------------|---------------------------------|--|
| <i>Rep.</i> | <i>Référence</i> | <i>ALIAS</i> | <i>Désignation</i> | <i>Remplacé par</i> | <i>Date début</i> | <i>Date fin</i> | <i>Multiple de vente</i> | <i>Tarif Public Unitaire HT</i> | |
| 201 | 64280312 | | MOTEUR VENTILATEUR KMF T71 | | | | 1 | 619,70 | |
| 202 | 64200300 | | TURBINE D EXTRACTEUR | | | | 1 | 79,90 | |
| 207 | 64201291 | | JOINT DE FORME | | | | 1 | 2,40 | |
| 208 | 17017112 | | PANNEAU RESTRICTION | | | | 1 | | |
| 210 | 65107852 | | COUVERCLE SUPERIEUR | | | | 1 | | |
| 211 | 64202491 | | COUVERCLE & PLAQUE DE POIDS R2909 R3600 | | | | 1 | | |
| 213 | 65000093 | | PRISE D'AIR + FILTRE R2789 | | | | 1 | 555,20 | |
| 214 | 65107849 | | PRISE D'AIR CHAMBRE ETANCHE | | | | 1 | | |

300



R8223937

| Table | | BLOC HYDRAULIQUE | | | | | | | |
|-------|------------|------------------|---|--------------|------------|----------|-------------------|--------------------------|--|
| Rep. | Référence | ALIAS | Désignation | Remplacé par | Date début | Date fin | Multiple de vente | Tarif Public Unitaire HT | |
| 301 | 64210206 | | CONTROLEUR DEBIT EAU F61-SB9100 | | | | 1 | 223,70 | |
| 304 | 64211303 | | SOUPAPE SECURITE 3 BARS 1 1/4 | | | | 1 | 134,20 | |
| 304 | 64201239 | | SOUPAPE SECURITE 3 BARS 1-1/2 | | | | 1 | 361,10 | |
| 305 | 64280522 | | SONDE DC (/ KM 628) | | | | 1 | 41,90 | |
| 306 | 65000459 | | MANOMETRE 0-10 BARS | | | | 1 | 202,40 | |
| 306 | 64201240 | | MANOMETRE 0-6 BARS | | | | 1 | 131,50 | |
| 306 | 64200087 | | RACCORD / MANOMETRE 0-->4 bars | | | | 1 | 24,00 | |
| 306 | 64210903 | | MANOMETRE 0-4 BARS | | | | 1 | 32,20 | |
| 308 | 64201241 | | PRESSOSTAT SDBRAM (MAX) | | | | 1 | 590,20 | |
| 309 | 64201242 | | PRESSOSTAT HUBA 625.9978 (MIN) | | | | 1 | 130,70 | |
| 311 | 4478694220 | | DOIGT DE GANT R9/R18 | | | | 1 | | |
| 314 | 64200512 | | JOINT PLAT D:95-58-3 | | | | 1 | 13,60 | |
| 316 | 64200998 | | JOINT PLAT D: 115-77-3 | | | | 1 | 9,10 | |
| 317 | 12083849 | | VOYANT DE CONTROLE (FLAMME) AVEC MIROIR | | | | 1 | 171,30 | |
| 318 | 65108160 | | TUYAU DE SIPHON 1/2 | | | | 1 | 86,10 | |
| 321 | 64280467 | | RACCORD BICONE DROIT 1/8 D.8 | | | | 1 | 14,00 | |
| 326 | 65108209 | | RACCORD 1/8 D.8 | | | | 1 | 15,40 | |
| 327 | 65108213 | | TUBE CUIVRE 6X8 mm L:2m | | | | 1 | 149,00 | |

400



| Table | | RAMPE GAZ | | | | | | | |
|--------------|------------------|------------------|-----------------------------|---------------------|-------------------|-----------------|--------------------------|---------------------------------|--|
| <i>Rep.</i> | <i>Référence</i> | <i>ALIAS</i> | <i>Désignation</i> | <i>Remplacé par</i> | <i>Date début</i> | <i>Date fin</i> | <i>Multiple de vente</i> | <i>Tarif Public Unitaire HT</i> | |
| 401 | 65107851 | | PLAQUE PREMELANGEUSE | | | | 1 | 202,30 | |
| 402 | 12037869 | | JOINT DE FORME | | | | 1 | 198,10 | |
| 403 | 64200598 | | JOINT DE FORME | | | | 1 | 63,70 | |
| 405 | 65108146 | | RESSORT DE PRESSION (10pcs) | | | | 1 | 32,10 | |
| 407 | 12016166 | | JOINT 12X3X20000 mm NEOPR. | | | | 1 | | |
| 408 | 65107854 | | KIT GARNITURE | | | | 1 | | |
| 409 | 64200511 | | JOINT 25X5X25000 mm PTFE | | | | 1 | | |



| Table | | BRULEUR | | | | | | | |
|--------------|------------------|----------------|----------------------------|---------------------|-------------------|-----------------|--------------------------|---------------------------------|--------|
| <i>Rep.</i> | <i>Référence</i> | <i>ALIAS</i> | <i>Désignation</i> | <i>Remplacé par</i> | <i>Date début</i> | <i>Date fin</i> | <i>Multiple de vente</i> | <i>Tarif Public Unitaire HT</i> | |
| 501 | 64201248 | | ECHANGEUR BRULEUR R2806 | | | | 1 | 4 | 566,30 |
| 502 | 64202264 | | ELECTRODE ALLUMAGE + JOINT | | | | 1 | | 47,50 |
| 503 | 64201562 | | ELECTRODE IONISATION | | | | 1 | | 57,00 |
| 504 | 64200325 | | JOINT DE FORME | | | | 1 | | 4,00 |
| 505 | 17010022 | | RACCORD M F | | | | 1 | | 18,10 |



| Table | | ECHANGEUR | | | | | | | |
|--------------|------------------|------------------|----------------------------------|---------------------|-------------------|-----------------|--------------------------|---------------------------------|--|
| <i>Rep.</i> | <i>Référence</i> | <i>ALIAS</i> | <i>Désignation</i> | <i>Remplacé par</i> | <i>Date début</i> | <i>Date fin</i> | <i>Multiple de vente</i> | <i>Tarif Public Unitaire HT</i> | |
| 601 | 64201262 | | 1er ECHANGEUR (tubes lisses) | | | | 1 | 3 836,00 | |
| 602 | 64201272 | | ECHANGEUR 2 (tubes ailettes) | | | | 1 | 7 607,60 | |
| 606 | 64200998 | | JOINT PLAT D: 115-77-3 | | | | 1 | 9,10 | |
| 607 | 4968707355 | | ISOLANT BLANC 14.64X0.013X0.085m | | | | 1 | 158,30 | |
| 608 | 64200834 | | ISOLANT 420X15X15mm | | | | 1 | 149,80 | |
| 609 | 64200830 | | ISOLANT 20X0.6X0.025 m | | | | 1 | 311,80 | |
| 610 | 64200817 | | ISOLANT 751X152X10mm | | | | 1 | 169,10 | |
| 611 | 4968707480 | | ISOLANT | | | | 1 | | |
| 612 | 64200815 | | ISOLANT LATERAL L:5m 50X5mm | | | | 1 | 131,80 | |
| 613 | 4968707344 | | ISOLEMENT BRULEUR | | | | 1 | | |

700



| Table | | ECHANGEURS | | | | | | | |
|--------------|------------------|-------------------|---------------------------------|---------------------|-------------------|-----------------|--------------------------|---------------------------------|--|
| <i>Rep.</i> | <i>Référence</i> | <i>ALIAS</i> | <i>Désignation</i> | <i>Remplacé par</i> | <i>Date début</i> | <i>Date fin</i> | <i>Multiple de vente</i> | <i>Tarif Public Unitaire HT</i> | |
| 702 | 64200436 | | JOINT L:5m | | | | 1 | | |
| 703 | 4148707742 | | COUVERCLE D'INSPECTION COMPLET | | | | 1 | 394,70 | |
| 703 | 6100055 | | INSPECTION BLIND HATCH COMPLETE | | | | 1 | 296,10 | |
| 705 | 64200281 | | RACCORD (KIT) | | | | 1 | 25,20 | |
| 706 | 64211228 | | ROBINET 1/2 (VANNE VIDANGE) | | | | 1 | 36,80 | |
| 707 | 64200847 | | RACCORD T 22X22X22 | | | | 1 | 27,30 | |
| 708 | 64200852 | | RACCORD L 22X22 | | | | 1 | 34,30 | |
| 709 | 64200980 | | PASSE TUBE | | | | 1 | 14,40 | |
| 710 | 65107853 | | RECUPERATEUR DE CONDENSAT | | | | 1 | | |
| 711 | 65107878 | | EQT TRANSFORMATION CONDENSEUR | | | | 1 | | |
| 717 | 64200822 | | PIEDS COMPLET (Qt:4) | | | | 1 | 184,60 | |

800



| Table | | BOITIER ELECTRIQUE | | | | | | | |
|-------|-----------|--------------------|-------------------------------------|--------------|------------|----------|-------------------|--------------------------|--|
| Rep. | Référence | ALIAS | Désignation | Remplacé par | Date début | Date fin | Multiple de vente | Tarif Public Unitaire HT | |
| 801 | 64201884 | | CABLAGE ELECTR. ALLU. | | | | 1 | | |
| 802 | 64210409 | | EMBOUT COUDE ELECTRODE IONISATION | | | | 1 | 24,80 | |
| 803 | 64202438 | | TRANSFORMATEUR 220V / KM628 | | | | 1 | 141,90 | |
| 804 | 64200873 | | VARIATEUR DE FREQUENCE 8201-E | | | | 1 | 884,50 | |
| 805 | 65000230 | | BOITIER DE COMMANDE KM628 | | | | 1 | 777,00 | |
| 805 | 64202435 | | SET CONNECTEURS KM628 | | | | 1 | | |
| 806 | 64201641 | | TRANSFORMATEUR ALLUMAGE+CABLE 2P | | | | 1 | 119,20 | |
| 807 | 64200294 | | INTERRUPTEUR | | | | 1 | 38,10 | |
| 808 | 64202260 | | CONNECTEUR M (KIT) pour 64280310 | | | | 1 | 119,70 | |
| 808 | 64280310 | | CIRCUIT IMPRIME CXE | | | | 1 | 438,80 | |
| 809 | 64201439 | | FILTRE ANTIPARASITE | | | | 1 | 200,50 | |
| 810 | 64201538 | | RELAIS ALAN BRADLEY 100-K09-KF10 | | | | 1 | 89,30 | |
| 810 | 64201539 | | RELAIS 100-K09KF10 & 193-K40 (A&B) | | | | 1 | 260,00 | |
| 811 | 64201300 | | CABLAGE ELECTRODE IONISATION | | | | 1 | 134,90 | |
| 812 | 64280407 | | PRESSOSTAT DIFFERENTIEL | | | | 1 | 109,10 | |
| 813 | 65000251 | | MODULE DE GESTION KKM8 | | | | 1 | 921,50 | |
| 813 | 65000252 | | REGULATEUR DE CHAUF (TYPE E8) | | | | 1 | 533,60 | |
| 813 | 64200788 | | MODULE CLIMATIQUE BM8 | | | | 1 | 560,30 | |
| 814 | 64210410 | | EMBOUT ELECTRODE HT | | | | 1 | 21,20 | |
| 819 | 64300004 | | THERMOSTAT IMIT LS100°C+SONDE L:3m | | | | 1 | 84,40 | |
| 820 | 65108167 | | FERRITE | | | | 1 | 35,60 | |
| 821 | 64211410 | | TRANSFORMATEUR (separateur) | | | | 1 | 190,80 | |
| 823 | 64211221 | | RELAIS 7A/250V-230V | | | | 1 | 16,90 | |
| 824 | 17008295 | | RELAIS TEMPORISE FINDER 85.02.8.240 | | | | 1 | 151,40 | |
| 825 | 64211314 | | SUPPORT RELAIS FINDER | | | | 1 | 13,00 | |
| 826 | 64200564 | | INTERFACE DE COM. COCO 2 | | | | 1 | 139,40 | |

5000

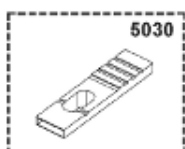
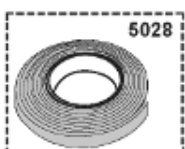
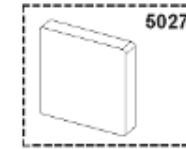
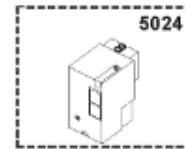
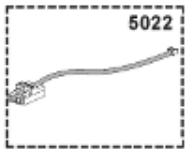
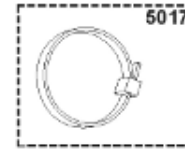
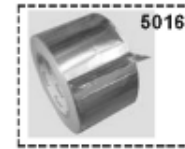

| Table | | OPTIONS | | | | | | | |
|-------|-------------|---------|--|--------------|------------|----------|-------------------|--------------------------|--|
| Rep. | Référence | ALIAS | Désignation | Remplacé par | Date début | Date fin | Multiple de vente | Tarif Public Unitaire HT | |
| 5001 | 64201836 | | SIPHON SEUL FSB | | | | 1 | 74,00 | |
| 5003 | 64921172 | | SONDE SPFS&KFS PLONG | | | | 1 | 63,90 | |
| 5004 | 64921173 | | SONDE VFAS | | | | 1 | 66,80 | |
| 5005 | 64921170 | | SONDE AFS EXT POUR KKM8 OU E8 | | | | 1 | 57,10 | |
| 5010 | 64200600 | | COLLE A1312 | | | | 1 | 242,70 | |
| 5010 | 65000352 | | COLLE A1044 | | | | 1 | 158,20 | |
| 5010 | 64200009 | | SILICONE HAUTE TEMPERATURE | | | | 1 | 61,50 | |
| 5010 | 64210199 | | COLLE OMNI VISC | | | | 1 | 68,40 | |
| 5010 | 64210200 | | CARTOUCHE SILICONE-1001U | | | | 1 | 15,40 | |
| 5010 | 64210202 | | COLLE REFRACTAIRE BOITE DE 1KG | | | | 1 | 33,30 | |
| 5011 | 65001192 | | REPLISSAGE DE GRANULÉS PAR KG | | | | 10 | 8,60 | |
| 5012 | 64200010 | | PAPIER INDICATEUR PH | | | | 1 | 59,50 | |
| 5013 | 64201515 | | CABLAGE SONDE DEPART | | | | 1 | 183,90 | |
| 5014 | 65108162 | | BOITIER CONTROLE FBR2 + SONDE / KM628 | | | | 1 | 97,80 | |
| 5016 | 65108158 | | RUBAN ALU ADHESIF 0.075X50m | | | | 1 | 99,30 | |
| 5017 | 65108166-01 | | TYRAPS 28X5 (Qt:100) | | | | 1 | 126,80 | |
| 5021 | 64200885 | | INTERFACE PC-KM+CAVO | | | | 1 | 638,40 | |
| 5022 | 64202164 | | CABLE COCO E6 R500&R2900 | | | | 1 | | |
| 5023 | 12047923 | | TOILE SILICONE/TRAPPE 0,1X1200X1000mm | | | | 1 | | |
| 5024 | 64201535 | | CONTROLEUR ETANCHEITE GAZ DUNGS VPS504 | | | | 1 | 870,80 | |
| 5026 | 17017015 | | JOINT DE FORME L:5M | | | | 1 | | |
| 5027 | 64200889 | | SONDE RFB | | | | 1 | 56,40 | |
| 5028 | 64202276 | | JOINT ISOLATION 25X3mm L:20m (neopr.) | | | | 1 | 188,70 | |
| 5030 | 65000433 | | SHUNT KM628 | | | | 1 | | |